PRODUCT CATALOG

Steel City[®]

Metallic boxes and covers



Steel City® products symbolise the highest quality standards in the manufacturing and innovative design, with one of the most complete offerings available. Dedicated to the commercial and residential construction industry, Steel City offers products manufactured within strict tolerances to maintain consistent performance. Installers can be assured that every fitting and box will work every time.

Table of contents

004–009	Overview
011	British Standard (BS) boxes
012–025	Switch boxes and accessories
026–032	Round/octagon boxes and accessories
033–035	Ceiling fan boxes and accessories
036–050	Square boxes and accessories
051–052	Utility boxes and accessories
053	Handy boxes and accessories
054–056	Gang boxes and accessories
057–060	Concrete/masonry boxes and accessories
061–064	Box hangers and supports
065–070	Stud wall and drywall accessories
071–075	Index

Overview

Steel City® metallic boxes and covers

01 Notched ears on switch boxes

Steel City® switch boxes feature a longer ear and a special notch. This provides clearance for the screws that are used to attach wall plates to GFCI or rocker-type light switches.

02 MS Bracket boxes

Mounts without the use of screws. Mounts to the open or closed side of the stud. Works on stud depths up to 4".

03 Eccentric knockouts on square boxes

Provide better contact with conduit fitting and locknut to the box, improve grounding path, stronger than 3/4" knockout. Available in all four standard-size square boxes. Improved 3/4" knockout position on square boxes. Less labor required to install 3/4" conduit to box. Square boxes also come with concentric Knockouts.

04 Raised ground screw bump in 4" square, 4¹¹/₁₆" and utility boxes

Quicker surface mounting by eliminating the need to remove the portion of the screw that threads through the back of the box. Allows for improved repositioning of grounding conductor. Ground bump standard in 2¹/₈" boxes. Ground bump standard in 1¹/₂" boxes.

05 Pre-installed screws are packaged in raised position

Eliminates extra step of having to back out the screw during cover installation.

Steel City® is the industry-leading product line of metallic switch and outlet boxes used in electrical construction. Since 1904, Steel City® products have symbolized the highest quality standards in manufacturing and innovative design, with one of the most complete offerings available.

Steel City® products are known for their simple improvements, such as being the first box offering to standardize combination slotted/ phillips screws on all boxes. Steel City® is also recognized as a leader in design innovation, as in our new metal stud bracket.

Steel City® continues to listen to contractors and responds to their ever-changing needs. Contact a Steel City® distributor nearest you to select the right product for your requirements.

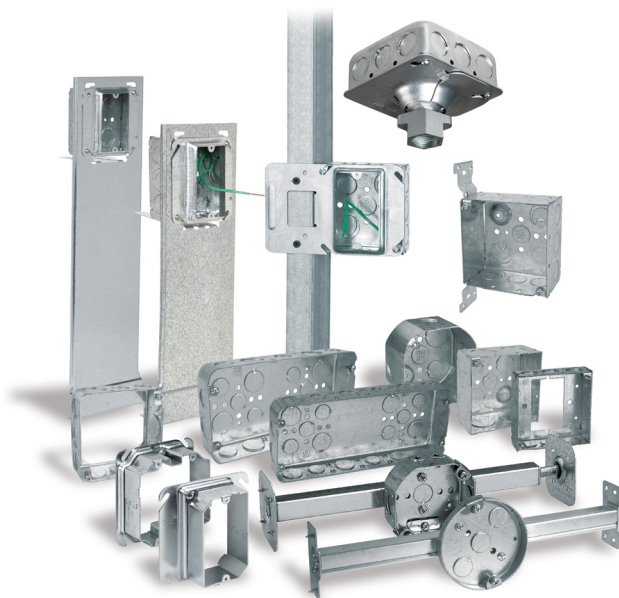

Advantages of Steel City® boxes and covers



01

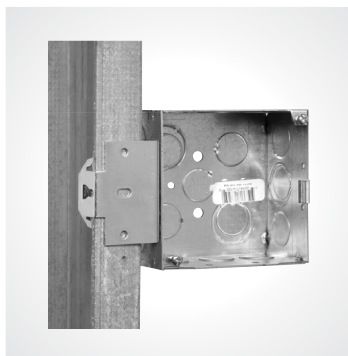

02



03



04



05

Steel City® switch and outlet boxes are protected from rust and corrosion by zinc-galvanizing. All clamps and other component parts are electrogalvanized separately, before assembly in the box, to ensure corrosion protection of every surface. Steel City® galvanized finish meets the requirements of Underwriters Laboratories, Inc. and Federal Specifications.

Guide to Steel City® knockouts, pryouts, ears, brackets and clamps

06 **Knockouts**

07 **Eccentric Knockouts**

08 **Pryouts**

09 **S or B Type bracket**

Mounts to face of stud. Used on switch, handy or square boxes. 2" long x 2 1/8" wide

10 **T Type bracket**

Positions handy box against the face and side of stud. 5 1/2" long x 7/8" wide

11 **SV Type bracket**

Mounts box to side of stud with positioning spikes. 7 3/8" long x 1" wide x 3/8" offset

12 **CV Type bracket (Outlet Boxes)**

Mounts to flat side of metal studs or wood studs. 7 3/8" long x 1" wide x 3/8" offset

13 **DV Type bracket**

Mounts box offset from stud 1 1/2". 6 3/8" long x 1" wide x 1 1/2" offset

14 **MS Type bracket (For Metal Studs)**

Mounts to any depth of metal stud, open or closed side. 2 1/2" long x 1 1/8" wide x 3/8" offset; Far side support to 4" only

15 **L Type bracket**

Used to mount octagon boxes. 2 3/8" long x 3 3/8" wide x 1/4" offset

16 **V Type bracket**

Mounts to flat side of stud. 7 3/8" long x 1" wide x 3/8" offset

Knockouts and Pryouts

Steel City® conduit KOs have standard trade size dimensions. KOs are uniform and true for attachment of cable or conduit connectors. Pryouts for cable entrance are slotted – a twist with a screwdriver removes them. KOs and Pryouts are precision stamped to permit easy removal, but remain sufficiently strong and sturdy when not removed.

Outlet box ears

Mounting ears support the box independent of the electrical system attachments. Switch boxes have a fixed ear for old work installations.

Ears for plaster are set 1/16" forward of the box face in position for old work (modernization), except where specifically noted.

Tapped holes for grounding

All Steel City® boxes have a 10-32 tapped hole in the bottom of the box for attaching separate ground wire.

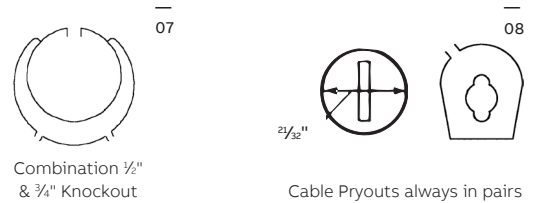
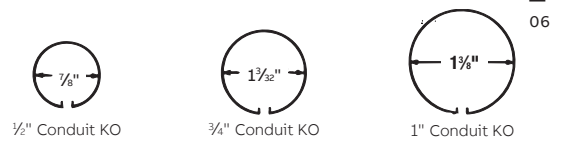



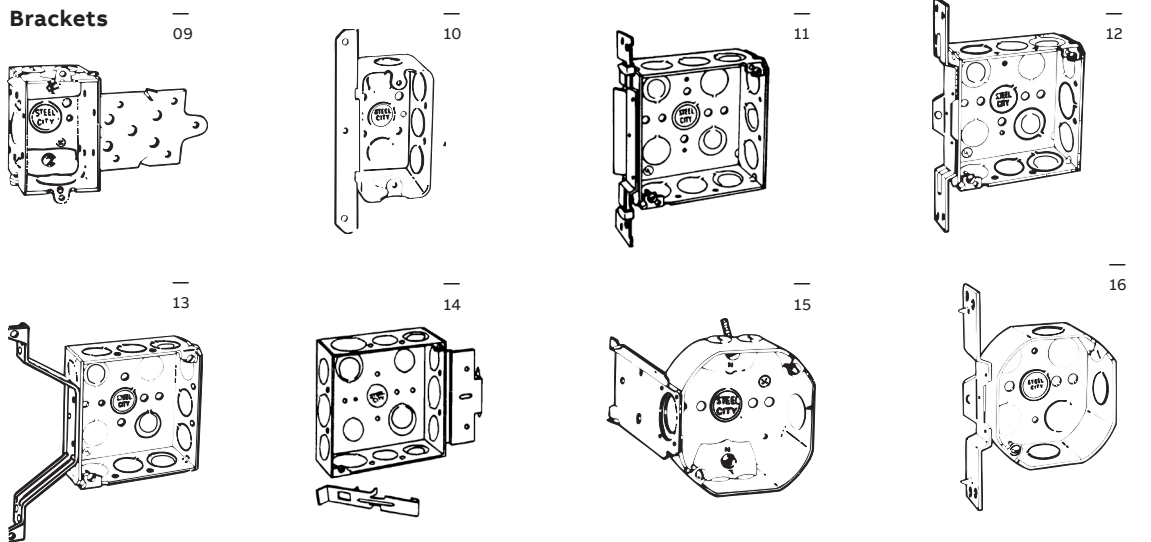

Brackets



Clamps - For non-metallic sheathed cable and non-metallic tubing (Loom)

UNDERWRITERS LABORATORIES INC. and CANADIAN STANDARDS ASSOCIATION file numbers for individual items available upon request.

Armored cable clamp – Type C-3

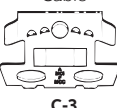
Description		Order Code
	Armored Cable (BX) – Steel	Sizes 14-2 through 10-3
	Armored Cable (BX) – Aluminum	Sizes 14-2 through 10-3
	MC Interlocked (MCI) – Steel	.449–.570 Diameter
	MC Interlocked (MCI) – Aluminum	.476–.606 Diameter
	MC Corrugated (MCC) – Aluminum	.375–.515 Diameter
	MCAP™ – Aluminum*	.370–.580
	Flex Metal Conduit – Steel	1/8" Trade Size
	Flex Metal Conduit – Aluminum	3/8" Trade Size
	C-3 Clamp Acceptable for Grounding	

* MCAP™ is a trademark of Southwire Company

"Products listed in this catalog are subject to alteration or discontinuation without prior notice."

Overview

NEC® Reference

Article 314 of the National Electrical Code® covers the installation and use of boxes. The article includes table references that guide the electrician in the selection of the proper box size necessary to safely accommodate electrical service requirements. The box capacity table shown (page 8) is reproduced in part from the NEC® as a quick reference and guide. The NEC® should be consulted for complete details.

Article 314 – Boxes and fittings

314.16 Number of conductors in outlet, device, and junction boxes, and conduit bodies.

Boxes and conduit bodies shall be of sufficient size to provide free space for all enclosed conductors. In no case shall the volume of the box, as calculated in 314.16(A), be less than the fill calculation as calculated in 314.16(B). The minimum volume for conduit bodies shall be as calculated in 314.16(C).

The provisions of this section shall not apply to terminal housings supplied with motors or generators. Informational Note: For volume requirements of motor or generator terminal housings, see Article 430.12. Boxes and conduit bodies enclosing conductors #4 AWG or larger shall also comply with the provisions of 314.28.

(A) Box volume calculations.

The volume of a wiring enclosure (box) shall be the total volume of the assembled sections and, where used, the space provided by plaster rings, domed covers, extension rings and so forth, that are marked with their volume or are made from boxes the dimensions of which are listed in Table 314.16(A).

(1) Standard boxes. The volumes of standard boxes that are not marked with their volume shall be as given in Table 314.16(A).

(2) Other boxes. Boxes 1650 cm³ (100 in.³) or less, other than those described in Table 314.16(A), and non-metallic boxes shall be durably and legibly marked by the manufacturer with their volume. Boxes described in Table 314.16(A) that have a volume larger than is designated in the table shall be permitted to have their volume marked as required by this section.

(B) Box fill calculations.

The volumes in paragraphs 314.16(B)(I) through (B)(5), as applicable, shall be added together. No allowance shall be required for small fittings such as locknuts and bushings.

(1) Conductor fill. Each conductor that originates outside the box and terminates or is spliced within the box shall be counted once, and each conductor that passes through the box without splice or termination shall be counted once. Each loop or coil of unbroken conductor not less than twice the minimum length required for free conductors in 300.14 shall be counted twice. The conductor fill shall be calculated using Table 314.16(B). A conductor, no part of which leaves the box, shall not be counted.

Exception: An equipment grounding conductor or conductors not over four fixture wires smaller than #14 AWG, or both, shall be permitted to be omitted from the calculations where they enter a box from a domed luminaire or similar canopy and terminate within that box.

(2) Clamp fill. Where one or more internal cable clamps, whether factory or field supplied, are present in the box, a single volume allowance in accordance with Table 314.16(B) shall be made based on the largest conductor present in the box. No allowance shall be required for a cable connector with its clamping mechanism outside the box.

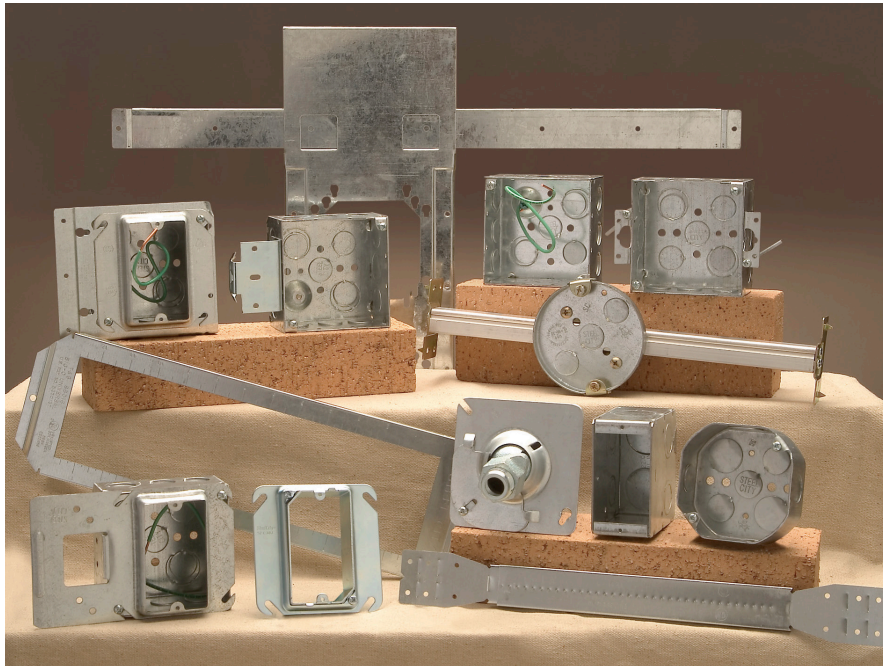

(3) Support fittings fill. Where one or more luminaire studs or hickies are present in the box, a single volume allowance in accordance with Table 314.16(B) shall be made for each type of fitting based on the largest conductor present in the box.

(4) Device or equipment. For each yoke or strap containing one or more devices or equipment, a double volume allowance in accordance with Table 314.16(B) shall be made for each yoke or strap based on the largest conductor connected to a device(s) or equipment supported by that yoke or strap. A device or utilization equipment wider than a single 50mm (2 in.) device box as described in Table 314.16(A) shall have double volume allowances provided for each gang required for mounting.

(5) Equipment grounding conductor. Where one or more equipment grounding conductors or equipment bonding jumpers enter a box, a single volume allowance in accordance with Table 314.16(B) shall be made based on the largest equipment grounding conductor or equipment bonding jumper present in the box. Where an additional set of equipment grounding conductors, as permitted by 250.146(D), is present in the box, an additional volume allowance shall be made based on the largest equipment grounding conductor in the additional set.

(C) Conduit bodies.

(1) General. Conduit bodies enclosing #6 AWG conductors or smaller, other than short-radius conduit bodies as described in 314.16(C)(2), shall have a cross-sectional area not less than twice the cross-sectional area of the largest conduit or tubing to which they can be attached. The maximum number of conductors permitted shall be the maximum number permitted by Table 1 of Chapter 9 for the conduit or tubing to which it is attached.

(2) With splices, taps or devices. Only those conduit bodies that are durably and legibly marked by the manufacturer with their volume shall be permitted to contain splices, taps or devices. The maximum number of conductors shall be calculated in accordance with 314.16(B). Conduit bodies shall be supported in a rigid and secure manner.

(3) Short-radius conduit bodies. Conduit bodies such as capped elbows and service-entrance elbows that enclose conductors #6 AWG or smaller, and are only intended to enable the installation of the raceway and the contained conductors, shall not contain splices, taps or devices and shall be of sufficient size to provide free space for all conductors enclosed in the conduit body.

Overview

NEC® Reference

Article 314 – Boxes and fittings (continued)

Table 314.16(A) - Metal boxes

(mm)	Box trade size (in.)		Maximum volume		Maximum number of conductors*						
			CM ³	IN. ³	18	16	14	12	10	8	6
100 x 32	(4 x 1 ¹ / ₄)	Round/Octagonal	205	12.5	8	7	6	5	5	5	2
100 x 38	(4 x 1 ¹ / ₂)	Round/Octagonal	254	15.5	10	8	7	6	6	5	3
100 x 54	(4 x 2 ¹ / ₂)	Round/Octagonal	353	21.5	14	12	10	9	8	7	4
100 x 32	(4 x 1 ¹ / ₄)	Square	295	18.0	12	10	9	8	7	6	3
100 x 38	(4 x 1 ¹ / ₂)	Square	344	21.0	14	12	10	9	8	7	4
100 x 54	(4 x 2 ¹ / ₈)	Square	497	30.3	20	17	15	13	12	10	6
120 x 32	(4L x 1 ¹ / ₄)	Square	418	25.5	17	14	12	11	10	8	5
120 x 38	(4L x 1 ¹ / ₂)	Square	484	29.5	19	16	14	13	11	9	5
120 x 54	(4L x 2 ¹ / ₈)	Square	689	42.0	28	24	21	18	16	14	8
75 x 50 x 38	(3 x 2 x 1 ¹ / ₂)	Device	123	7.5	5	4	3	3	3	2	1
75 x 50 x 50	(3 x 2 x 2)	Device	164	10.0	6	5	5	4	4	3	2
75 x 50 x 57	(3 x 2 x 2 ¹ / ₄)	Device	172	10.5	7	6	5	4	4	3	2
75 x 50 x 65	(3 x 2 x 2 ¹ / ₂)	Device	205	12.5	8	7	6	5	5	4	2
75 x 50 x 70	(3 x 2 x 2 ³ / ₄)	Device	230	14.0	9	8	7	6	5	4	2
75 x 50 x 90	(3 x 2 x 3 ¹ / ₂)	Device	295	18.0	12	10	9	8	7	6	3
100 x 54 x 38	(4 x 2 ¹ / ₈ x 1 ¹ / ₂)	Device	169	10.3	6	5	5	4	4	3	2
100 x 54 x 48	(4 x 2 ¹ / ₈ x 1 ⁷ / ₈)	Device	213	13.0	8	7	6	5	5	4	2
100 x 54 x 54	(4 x 2 ¹ / ₈ x 2 ¹ / ₈)	Device	238	14.5	9	8	7	6	5	4	2
95 x 50 x 65	(3 ³ / ₄ x 2 x 2 ¹ / ₂)	Masonry Box/Gang	230	14.0	9	8	7	6	5	4	2
95 x 50 x 90	(3 ³ / ₄ x 2 x 3 ¹ / ₂)	Masonry Box/Gang	344	21.0	14	12	10	9	8	7	4
Min. 44.5 depth FS – Single-Cover/Gang (1 ³ / ₄)			221	13.5	9	7	6	6	5	4	2
Min. 60.3 depth FD – Single-Cover/Gang (2 ³ / ₈)			295	18.0	12	10	9	8	7	6	3
Min. 44.5 depth FS – Multiple-Cover/Gang (1 ³ / ₄)			295	18.0	12	10	9	8	7	6	3
Min. 60.3 depth FD – Multiple-Cover/Gang (2 ³ / ₈)			395	24.0	16	13	12	10	9	8	4

* Where no volume allowances are required by 314.16(B)(2) through 314.16(B)(5).

Underwriters Laboratories Inc. File Number: E2969 (U.L. 514A)

Canadian Standards Association File Number: LR12798

Federal Manufacture Number: 56501 (Cage Code)

Products designed to meet Federal Specification Number: W-J-800

Verification of file numbers and compliance with federal specifications for individual items available upon request.

Box and cover material and plating specification; .062" minimum thickness, hot rolled, pre-galvanized steel, minimum spangle.

ASTM G-60-U, AISI C-1008

Bracket material: All brackets except MS style; 16 gauge (.060") hot rolled, pregalvanized steel AISI C-1008, G-90-U. MS style bracket; 20 gauge (.036") cold rolled spring steel AISI C-1055, heat treated to R. 35 zinc plated .0005 thick.

—
Table 314.16(B) - Volume allowance required per conductor

Size of conductor (AWG)	Free space within box for each conductor	
	(cm ³)	(in. ³)
No. 18	24.6	1.50
No. 16	28.7	1.75
No. 14	32.8	2.00
No. 12	36.9	2.25
No. 10	41.0	2.50
No. 8	49.2	3.00
No. 6	81.9	5.00

Reprinted with permission from National Fire Protection Association NFPA70-2011.

National Electrical Code, Copyright© 2010, National Fire Protection Association, Quincy, MA 02269. This reprinted material is not the complete and official position of the NFPA on the referenced subject which is represented only by the standard in its entirety.

NEC® is a registered trademark of the National Fire Protection Association, Inc., Quincy, MA 02269.

Underwriters Laboratories Inc. File Number: E2969 (U.L. 514A)

Canadian Standards Association File Number: LR 12798

Federal Manufacture Number: 56501

Products designed to meet Federal Specification Number: A-A5924 (formerly W-J-800).

Verification of file numbers and compliance with federal specifications for individual items available upon request.

Box and cover material and plating specification; .062" minimum thickness, hot-rolled, pre-galvanized steel, minimum spangle.

ASTM G-60-U, AISI C-1008

Bracket material: All brackets except MS style; 16 gauge (.060") hot rolled, pregalvanized steel AISI C-1008, G-60-U. MS Style bracket; 20 gauge (.036") cold rolled spring steel AISI C-1055, heat treated to R. 35 zinc plated .0005 thick.

Metallic boxes — Fire resistance rating

Wall Penetrations

Listed single- and double-gang metallic outlet and switch boxes and octagon ceiling boxes with metallic or non-metallic cover plates may be used in bearing and non-bearing wood stud and steel stud walls with ratings not exceeding 2 hours. These walls shall have gypsum wallboard facings similar to those shown in Design Nos. U301, U411, and U425. 4 in. square boxes may be used in 2 hr. fire rated ceilings.

The surface area of individual metallic outlet or switch boxes shall not exceed 16 sq. in.

The aggregate surface area of the boxes shall not exceed 100 sq. inches per 100 sq. ft. of wall.

Boxes located on opposite sides of walls or partitions shall be separated by a horizontal distance of 24 inches.

The metallic outlet or switch boxes shall be securely fastened to the studs and the opening in the wallboard facing shall be cut so that the clearance between the box and the wallboard does not exceed 1/8 in.

STEEL CITY®

The quality and reliability of our metallic boxes have made Steel City the number one choice for contractors and electricians around the world.

No jobs are too big or too small for our boxes.

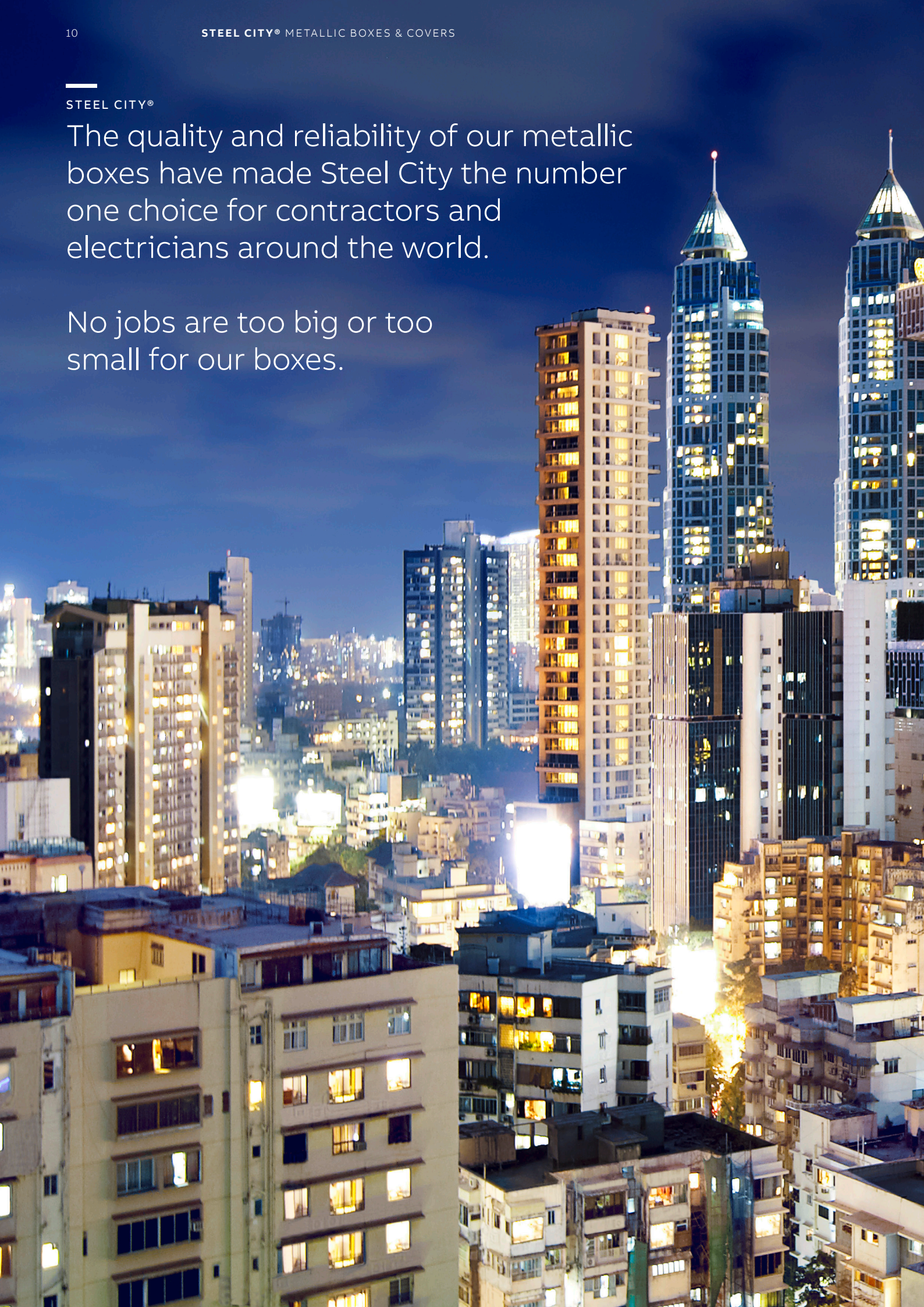

Steel City®

British Standards (BS) boxes now available

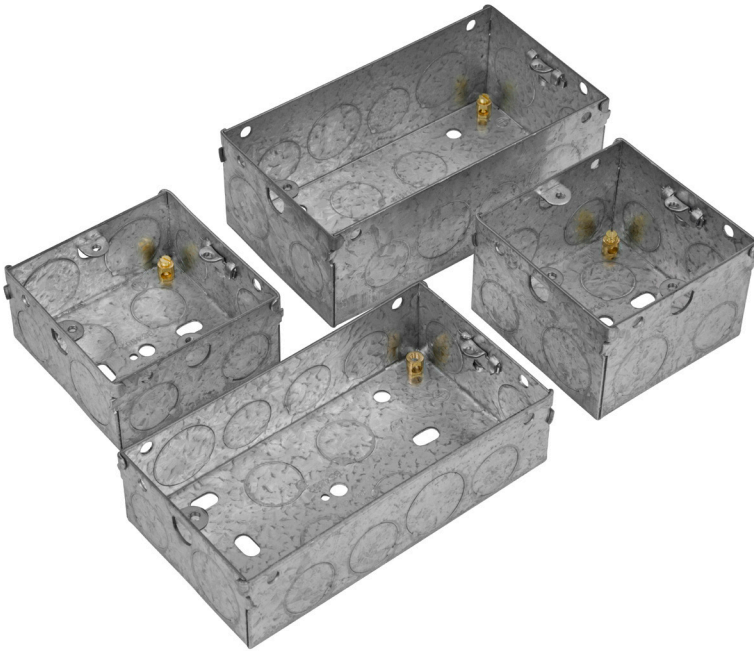

We have manufactured Steel City boxes for more than 100 years.

We will be manufacturing British Standard (BS) boxes in Saudi Arabia for the Middle East market, continuing our commitment to serve commercial and residential builders with regionally made products wherever possible. BS boxes include:

- Two adjustable mounting lugs on single gang boxes to increase flexibility during and after installation
- Two thicknesses (0.9 and 1.1mm) installation

Features and benefits:

- A general earthing terminal
- Adjustable mounting lugs
- Pre-galvanized steel construction
- One- or two-gang sizes
- 20 mm or 25 mm knockout diameters

British Standard boxes



Cat. No.	Steel Thickness		Dimensions (H x W x D)		Capacity		Adjustable Mounting Lugs
	(mm)	(in.)	(mm)	(in.)	(cm ³)	(in. ³)	
SFB135	0.9	0.040	(72 x 72 x 35)	(2.8 x 2.8 x 1.4)	171.8	10.5	1
SFB135-2	0.9	0.040	(72 x 72 x 35)	(2.8 x 2.8 x 1.4)	171.6	10.5	2
SFB147	0.9	0.040	(72 x 72 x 47)	(2.8 x 2.8 x 1.9)	230.9	14.1	1
SFB147-2	0.9	0.040	(72 x 72 x 47)	(2.8 x 2.8 x 1.9)	230.7	14.1	2
SFB235	0.9	0.040	(72 x 132 x 35)	(2.8 x 5.2 x 1.4)	320.5	19.6	1
SFB247	0.9	0.040	(72 x 132 x 47)	(2.8 x 2.8 x 1.4)	430.6	26.3	1
SFB-135-11	1.1	0.043	(72 x 72 x 35)	(2.8 x 2.8 x 1.4)	169.7	10.4	1
SFB135-2 -11	1.1	0.043	(72 x 72 x 35)	(2.8 x 2.8 x 1.4)	169.5	10.3	2
SFB-147-11	1.1	0.043	(72 x 72 x 47)	(2.8 x 2.8 x 1.9)	228.2	13.9	1
SFB147-2 -11	1.1	0.043	(72 x 72 x 47)	(2.8 x 2.8 x 1.9)	227.9	13.9	2
SFB-235-11	1.1	0.043	(72 x 132 x 35)	(2.8 x 5.2 x 1.4)	317.7	19.4	1
SFB-247-11	1.1	0.043	(72 x 132 x 47)	(2.8 x 2.8 x 1.4)	426.8	26.0	1

Switch boxes and accessories

Steel City® super deep 4" square wall boxes and 5" square box



521911234RD

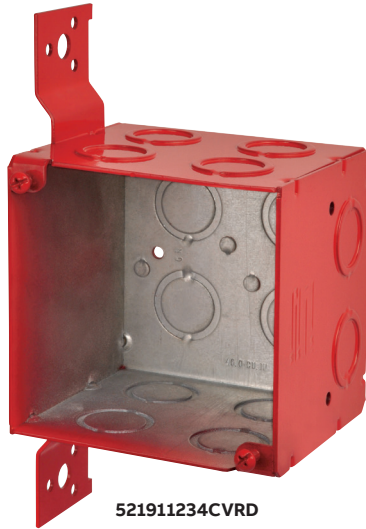

521911234CVRD



521911234



521911234CV



82181-1234-RD

Features and benefits:

- Increased capacity accommodates large devices in commercial and industrial applications, such as fire alarm systems
- Red-painted version available for quick and easy identification of life safety electrical systems
- Available with or without integrally mounted support bracket

5" Square boxes

- Offer more than double the cubic-inch capacity of a standard 4 in. - square deep box, making it faster and easier to route wiring and make terminations in the box. Save labor turn a two-man job into a one-man job by storing the slack cable loop in the box for easy access by a single technician when terminating communications cables. The extra room in the 5 SQUARE box dramatically reduces the likelihood of ground faults and short circuits when installing large fire alarm devices.

Steel City® super deep 4" square wall boxes

Cat. No.	Description	Ears	Brackets	Each side KO	Each end KO	Bottom KO	Capacity (cu. in.)	Std. Ctn.
521911234RD	3 1/2"- deep, 4"- square red box	-	-	(4) 1/2" & 3/4" combo	(2) 1/2" & 3/4" combo	(4) 1/2" & 3/4" combo	46	24
521911234CVRD	3 1/2"- deep, 4"- square red box with side mounting bracket	-	CV	(4) 1/2" & 3/4" combo	(2) 1/2" & 3/4" combo	(4) 1/2" & 3/4" combo	46	10
521911234	3 1/2"- deep, 4"- square box	-	-	(4) 1/2" & 3/4" combo	(2) 1/2" & 3/4" combo	(4) 1/2" & 3/4" combo	46	24
521911234CV	3 1/2"- deep, 4"- square box with side mounting bracket	-	CV	(4) 1/2" & 3/4" combo	(2) 1/2" & 3/4" combo	(4) 1/2" & 3/4" combo	46	10
82181-1234-RD	2 7/8"- deep, 5"- square Fire signal red box	-	-	(3) 1/2" & 3/4" combo	(3) 1/2" & 3/4" combo	(3) 1/2" & 3/4" combo	67	20

Switch boxes and accessories

Adjust-A-Box®

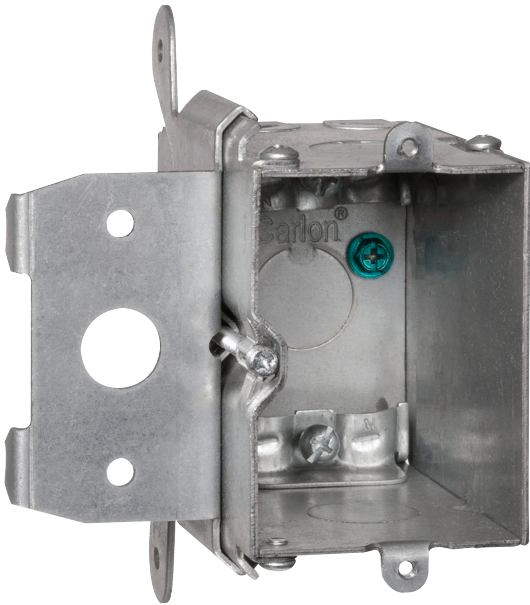

MB120ADJ

Easy depth adjustment after wall covering installation.

The Adjust-A-Box® system adapts to a variety of wall coverings. Its unique design enables the installer to adjust the box to various depths with the turn of a screw.

Features and benefits:

- Unique design allows for adjustment of depth after the wall covering has been installed
- Adjusts to any wall covering
- Mounts square and secure every time
- Removes easily to enable inner-wall access
- Accommodates high- and low-voltage applications
- Pre-installed ground screw
- Accommodates non-metallic cable, flexible metal cable and EMT

Installation:

01 Screw bracket to stud

02 Adjust box in or out to any wall thickness

01

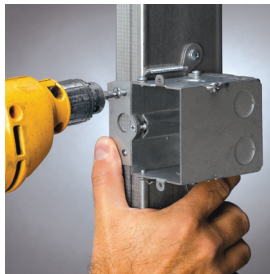

Single-gang

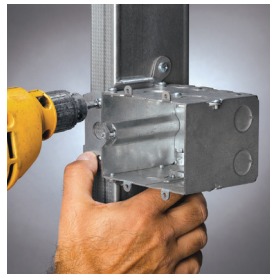

Two-gang

02



Single-gang



Two-gang

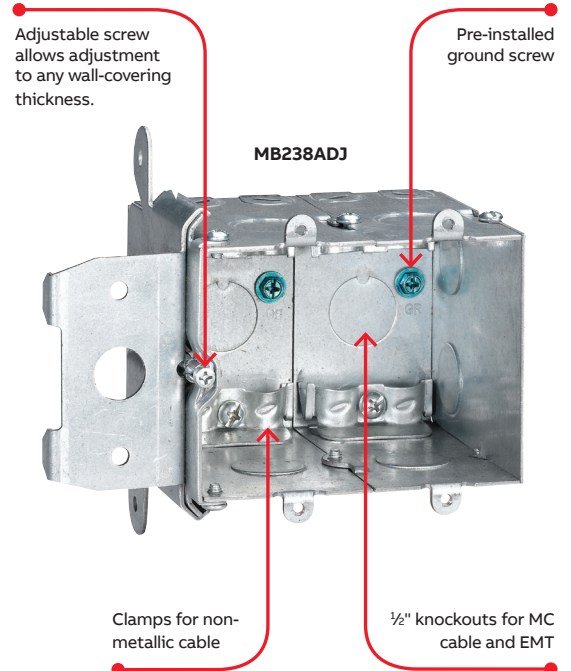

Pre-Fab box bracket with far-side and cable support

Cat. No.	Volume (cu. in.)	Description	Knockouts	Size (in.)	Std. Ctn.	Std. Wt. (lbs.)
MB120ADJ	20	One-gang adjustable wall box	1/2" (5)	2.20W x 3.28H x 3.52D	18	19.25
MB238ADJ	38	Two-gang adjustable wall box	1/2" (8)	4.01W x 3.28H x 3.52D	12	17.60

Switch boxes and accessories

3³/₄" x 2" Switch boxes



SSV

 SSQV
 with non-metallic
 sheathed cable

3³/₄" x 2" Switch Boxes

Cat. No.	Depth (in.)	Capacity (cu. in.)	Clamps	Ears	Brackets	Knockouts	Std. Ctn.
Non-Gangable							
SSV	1	6.5	–	–	Flat	2 pry-outs one end	25
SSQV	1	6.5	Yes	–	Flat	2 pry-outs one end with non-metallic cable clamps	25

* Not UL listed.

Switch boxes and accessories

3" x 2" Switch Boxes

01 SWB-25
Ears flush for old work



02 811-SW-25
S bracket recessed 5/8"

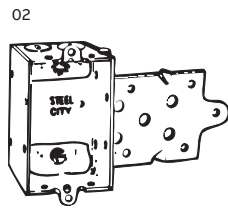

03 LXMWOW-25
Ears flush for old work

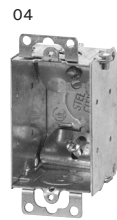

04 LCOW-25 Ears
flush for old work



05 LCOWC Adapts to any
wall thickness up to 3/4"



06 LCLE-25

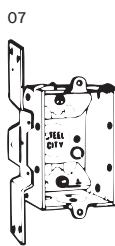

07 LCV-25
CV bracket recessed 3/4"



08 LCNOW-25
Ears flush for old work

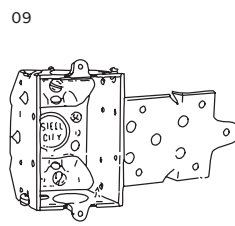

09 802-S
S bracket recessed 5/8"



10 A12-25



11 A12E-25 Ears flush

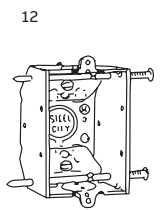

12 A16-25 With nails



13 LXWOW-25
Ears flush for old work



14 LXWOWP



15 LXWLE-25



16 LXWOWC-25
Adapts to any wall
thickness up to 3/4"



17 LXWSV
SV bracket recessed 7/16"



18 LXWV-25
CV bracket recessed 7/8"

With non-metallic sheathed cable clamps

Cat. No.	Depth (in.)	Gangable	Capacity (cu. in.)	Clamps	Ears	Brackets	Knockouts (in.)					Std. Ctn.
							Ea. end conduit	Ea. end cable	Cable	Bottom cable	Bottom conduit	
SWB-25	1 1/2	-	7.5	C-5	Yes	-	-	2	-	2	-	25
811 SW-25	1 1/2	-	7.5	C-5	-	S	-	2	-	2	-	50
LXMWOW-25	2	Yes	10.5	C-5	Yes	-	-	2	-	-	1-1/2	25
LCOW-25*	2 1/4	Yes	10.5	C-1	Yes	-	1-1/2	-	2	-	1-1/2	25
LCOWC*	2 1/4	Yes	10.5	C-1	Yes	-	1-1/2	-	2	-	1-1/2	25
LCLE-25*	2 1/4	Yes	10.5	C-1	-	-	1-1/2	-	2	-	1-1/2	25
LCV-25*	2 1/4	Yes	10.5	C-1	-	CV	1-1/2	-	2	-	1-1/2	25
LCNOW-25*	2 1/4	Yes	10.5	C-1	Yes	-	1-1/2	-	2	-	1-1/2	25
802 S*	2 1/4	Yes	10.5	C-1	-	S	1-1/2	-	2	-	1-1/2	25
A12-25	2 1/4	-	10.5	C-1	-	-	1-1/2	-	2	-	1-1/2	25
A12E-25	2 1/4	-	10.5	C-1	Yes	-	1-1/2	-	2	-	1-1/2	25
A16-25	2 1/4	-	10.5	C-1	-	-	1-1/2	-	2	-	1-1/2	25
LXWOW-25	2 1/2	Yes	12.5	C-5	Yes	-	1-1/2	-	2	-	1-1/2	25
LXWOWP	2 1/2	Yes	12.5	C-5	Yes	-	1-1/2	-	2	-	1-1/2	25
LXWLE-25	2 1/2	Yes	12.5	C-5	-	-	1-1/2	1-1/2	2	-	1-1/2	25
LXWOWC-25	2 1/2	Yes	12.5	C-5	Yes	-	1-1/2	-	2	-	1-1/2	25
LXWSV	2 1/2	Yes	12.5	C-5	-	SV	1-1/2	1-1/2	2	-	1-1/2	25
LXWV-25	2 1/2	Yes	12.5	C-5	-	CV	1-1/2	1-1/2	2	-	1-1/2	25

* Beveled corners.

Switch boxes and accessories

3" x 2" Switch Boxes (continued)

01 **LXWV 2G**
2-gang with CV bracket
recessed 7/8"

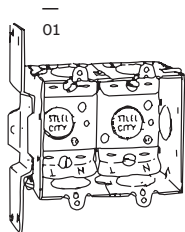

02 **806 SW**
S bracket recessed 5/8"

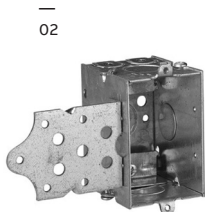

03 **806 SW 1/4**
S bracket recessed 1/4"

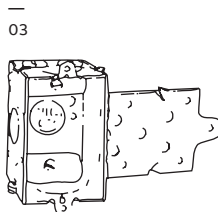

04 **A254-25**

05 **A257-25**
With nails slanted
for easy drive-in

06

07

08

09

10

06 **A-258**
Without nails



07 **CWN-25**
Ears flush

08 **CWNLE**

09 **CWNV-25**
CV bracket recessed 7/8"

10 **CXWLE**

11 **CXWOW**
Ears flush for old work

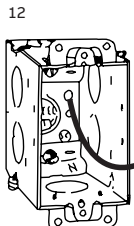

12 **CXWOWP**

13 **CXWV**
CV bracket recessed 7/8"

14 **CXWVP**

With non-metallic sheathed cable clamps (continued)

Cat. No.	Depth (in.)	Gangable	Capacity (cu. in.)	Clamps	Ears	Brackets	Knockouts (in.)					
							Ea. end conduit	Ea. end cable	Cable	Bottom cable	Bottom conduit	Std. Ctn.
LXWV 2G	2½	Yes	12.5	C-5	-	CV	1-½	2-½	4	-	2-½	25
806 SW	2½	Yes	12.5	C-5	-	S	1-½	1-½	2	-	1-½	25
806 SW 1/4	2½	Yes	12.5	C-5	-	S	1-½	1-½	2	-	1-½	25
A254-25	2½	-	12.5	C-5	-	-	-	1-½	2	-	1-½	25
A257-25	2½	-	12.5	C-5	-	-	-	1-½	2	-	1-½	25
A-258	2½	-	12.5	C-5	-	-	-	1-½	2	-	1-½	25
CWN-25	2¾	Yes	14.0	C-5	Yes	-	1-½	-	2	-	1-½	25
CWNLE	2¾	Yes	14.0	C-5	-	-	1-½	-	2	-	1-½	25
CWNV-25	2¾	Yes	14.0	C-5	-	CV	1-½	-	2	-	1-½	25
CXWLE	3½	Yes	18.0	C-5	-	-	2-½	1-½	2	-	1-½	25
CXWOW	3½	Yes	18.0	C-5	Yes	-	2-½	1-½	2	-	1-½	25
CXWOWP	3½	Yes	18.0	C-5	Yes	-	2-½	1-½	2	-	1-½	25
CXWV	3½	Yes	18.0	C-5	-	CV	2-½	1-½	2	-	1-½	25
CXWVP	3½	Yes	18.0	C-5	-	CV	2-½	1-½	2	-	1-½	25

Switch boxes and accessories

3" x 2" Switch Boxes (continued)

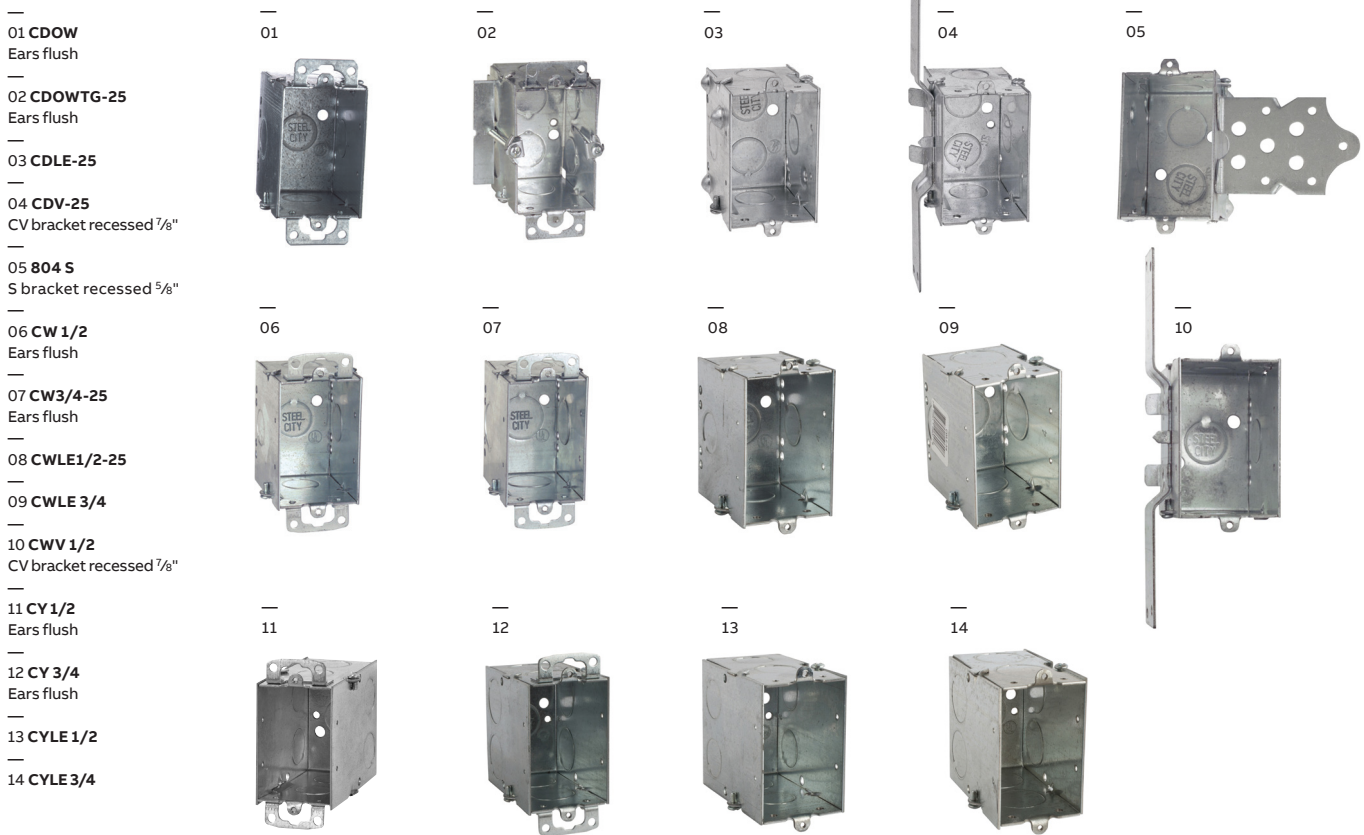

With conduit KOs

Cat. No.	Depth (in.)	Gangable	Capacity (cu. in.)	Ears	Brackets	Knockouts (in.)			Std. Ctn.
						Ea. end conduit	Ea. end cable	Bottom conduit	
CDOW	2½	Yes	12.5	Yes	–	1½	1½	2½	50
CDOWTG-25	2½	Yes	12.5	Yes	–	1½	1½	2½	25
CDLE-25	2½	Yes	12.5	–	–	1½	1½	2½	25
CDV-25	2½	Yes	12.5	–	CV	1½	1½	2½	25
804 S	2½	Yes	12.5	–	S	1½	1½	2½	25
CW 1/2	2¾	Yes	14.0	Yes	–	1-½	1-½	1-½	50
CW3/4-25	2¾	Yes	14.0	Yes	–	1-¾	1-¾	1-¾	25
CWLE1/2-25	2¾	Yes	14.0	–	–	1-½	1-½	1-½	25
CWLE 3/4	2¾	Yes	14.0	–	–	1-¾	1-¾	1-¾	25
CWV 1/2	2¾	Yes	14.0	–	CV	1-½	1-½	1-½	25
CY 1/2	3½	Yes	18.0	Yes	–	2-½	2-½	1-½	25
CY 3/4	3½	Yes	18.0	Yes	–	2-¾	2-¾	1-½	25
CYLE 1/2	3½	Yes	18.0	–	–	2-½	2-½	1-½	25
CYLE 3/4	3½	Yes	18.0	–	–	2-¾	2-¾	1-½	25

Switch boxes and accessories

3" x 2" Switch Boxes (continued)

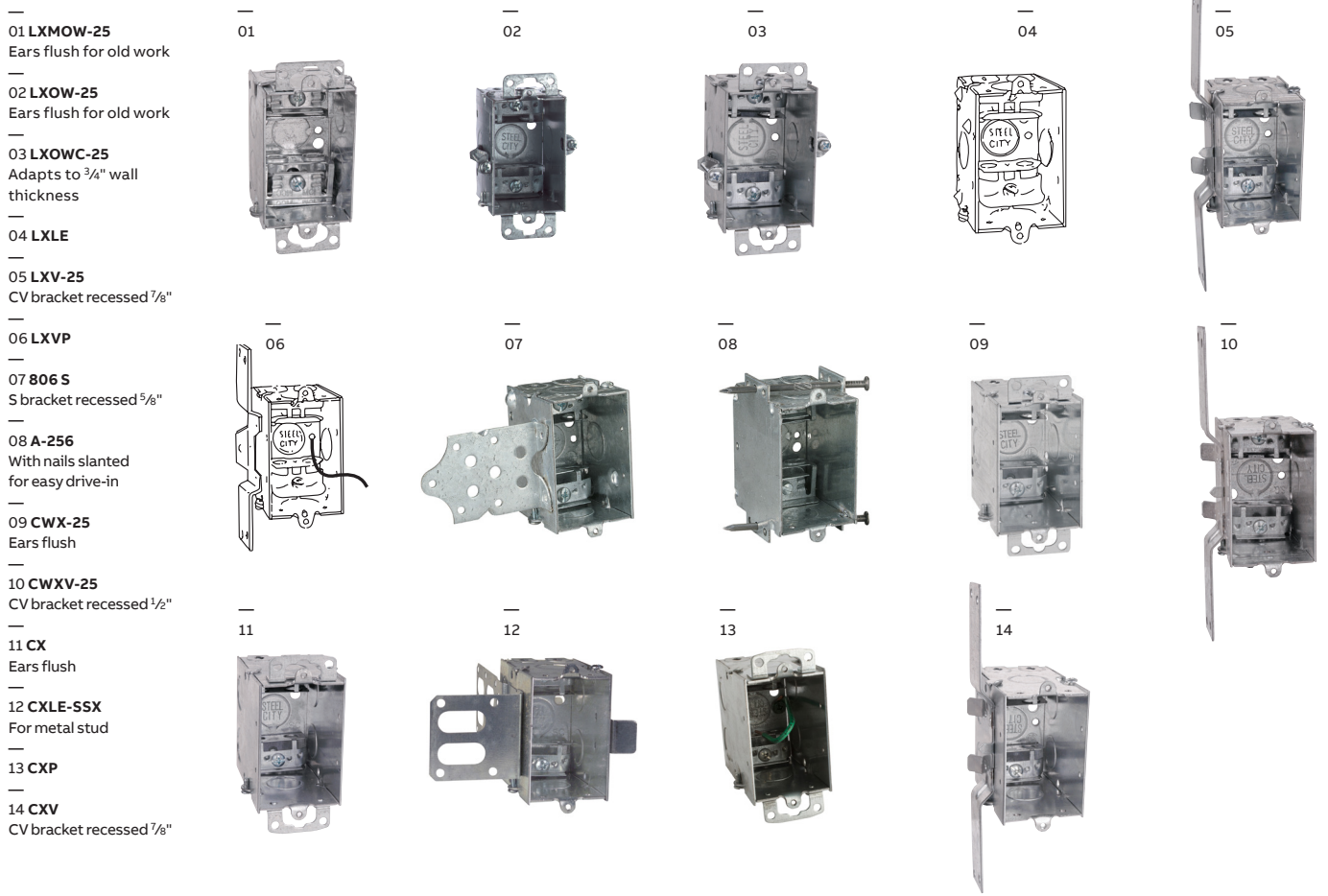

With armored cable/metal clad clamps

Cat. No.	Depth (in.)	Gangable	Capacity (cu. in.)	Clamps	Ears	Brackets	Knockouts (in.)				
							Ea. end conduit	Ea. end cable	Cable	Bottom conduit	Std. Ctn.
LXMOW-25	2	Yes	10.5	C-3	Yes	-	-	2	-	1-1/2	25
LXOW-25	2 1/2	Yes	12.5	C-3	Yes	-	1-1/2	-	2	1-1/2	25
LXOWC-25	2 1/2	Yes	12.5	C-3	Yes	-	1-1/2	-	2	1-1/2	25
LXLE	2 1/2	Yes	12.5	C-3	-	-	1-1/2	1-1/2	2	1-1/2	25
LXV-25	2 1/2	Yes	12.5	C-3	-	CV	1-1/2	1-1/2	2	1-1/2	25
LXVP	2 1/2	Yes	12.5	C-3	-	CV	1-1/2	1-1/2	2	1-1/2	25
806 S	2 1/2	Yes	12.5	C-3	-	S	1-1/2	1-1/2	2	1-1/2	25
A-256	2 1/2	-	12.5	C-3	-	-	-	1-1/2	2	1-1/2	25
CWX-25	2 3/4	Yes	14.0	C-3	Yes	-	1-1/2	-	2	1-1/2	25
CWXV-25	2 3/4	Yes	14.0	C-3	-	CV	1-1/2	-	2	1-1/2	25
CX	3 1/2	Yes	18.0	C-3	Yes	-	2-1/2	1-1/2	2	1-1/2	25
CXLE-SSX	3 1/2	Yes	18.0	C-3	No	SSX	2-1/2	1-1/2	2	1-1/2	25
CXP	3 1/2	Yes	18.0	C-3	Yes	-	2-1/2	1-1/2	2	1-1/2	25
CXV	3 1/2	Yes	18.0	C-3	-	CV	2-1/2	1-1/2	2	1-1/2	25

Switch boxes and accessories

Gangable switch boxes - 2" deep



51

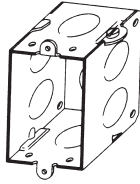

51-NE

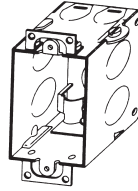

51-LC

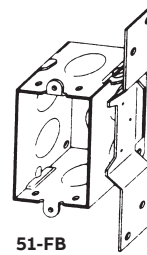

51-FB

Gangable switch boxes - 2" deep

Cat. No.	Capacity (cu. in.)	Description	Std. Ctn.
51	10.0	Two 1/2" KOs in each of two sides, one 1/2" KO in each end and two 1/2" KOs in bottom. Two nail holes in sides. Furnished with plaster ears*	50
51-NE	10.0	Two 1/2" KOs in each of two sides, one 1/2" KO in each end and two 1/2" KOs in bottom. Two nail holes in sides*	50
51-LC	10.0	For non-metallic cable, 2" deep x 3" long x 2" wide Two 1/2" KOs in each of two sides, two loom KOs in each end and one 1/2" KO in bottom. Furnished with plaster ears. One loom clamp for use on non-metallic sheathed cable with 10/32 deep-slotted screw assembled. Two nail holes in sides*	50
51-FB	10.0	2" deep x 3" long x 2" wide Two 1/2" KOs in one side, flat bracket on other side, one 1/2" KO in each end and two 1/2" KOs in bottom. Bracket offset 9/16" from face*	50

*Uses Steel City® 100 series covers.

Gangable switch boxes - 2 1/2" deep

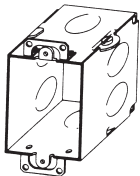

52

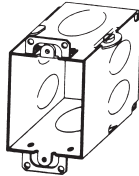

52-3/4-BW

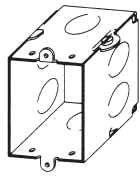

52-NE

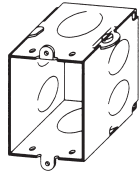

52-NE-3/4

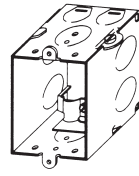

52-LCNE



52-FB-3/4

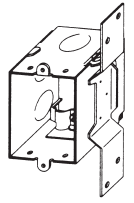

52-FBC

Gangable switch boxes - 2 1/2" deep

Cat. No.	Capacity (cu. in.)	Description	Std. Ctn.
52	12.5	Two 1/2" KOs in each of two sides, one 1/2" KO in each end and two 1/2" KOs in bottom. Furnished with plaster ears. Four nail holes in sides*	50
52-3/4-BW	12.5	Two 1/2" KOs in each of two sides, one 3/4" KO in each end and two 1/2" KOs in bottom. Furnished with plaster ears. Four nail holes in sides*	50
52-NE	12.5	Two 1/2" KOs in each of two sides, one 1/2" KO in each end and two 1/2" KOs in bottom. Four nail holes in sides*	50
52-NE-3/4	12.5	Two 1/2" KOs in each of two sides, one 3/4" KO in each end and two 1/2" KOs in bottom. Four nail holes in sides*	50
52-LCNE	12.5	For non-metallic cable, 2 1/2" deep x 3" long x 2" wide Two 1/2" KOs in each side, two loom KOs and one 1/2" KO in each end. One 1/2" KO in bottom. One loom clamp for use on non-metallic sheathed cable with 10/32 deep-slotted screw assembled. Four nail holes in sides*	50
52-FB-3/4	12.5	2 1/2" deep x 3" long x 2" wide Two 1/2" KOs in one side, flat bracket on other side, one KO in each end and two 3/4" KOs in bottom. Flat bracket offset 9/16" from face*	50
52-FBC	12.5	For non-metallic cable, 2 1/2" deep x 3" long x 2" wide Two 1/2" KOs in one side, flat bracket on other side, two loom KOs and one 1/2" KO in each end and one 1/2" KO in bottom. One loom clamp for use on non-metallic sheathed cable with 10/32 deep-slotted screw assembled. Flat bracket offset 9/16" from face*	50

*Uses Steel City® 100 series covers.

Switch boxes and accessories

Gangable switch boxes - 2³/₄" deep

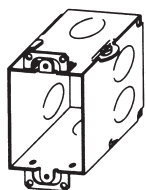

53

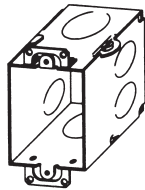

53-3/4-BW

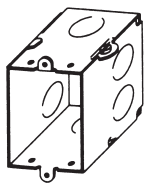

53-NE

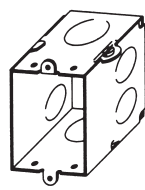

3-NE-3/4

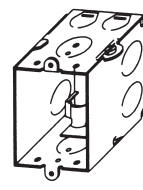

53-LCNE

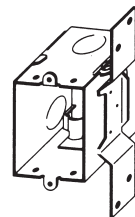

53-FB

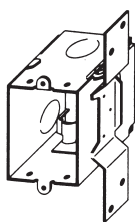

53-FBC

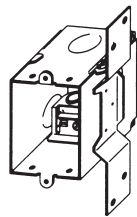

53-FB-MXN

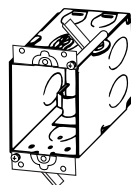

53-OWEC

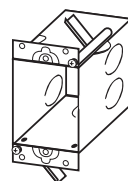

53-OWE

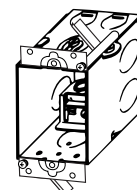

53-OWE-MXN

Gangable switch boxes - 2³/₄" deep

Cat. No.	Capacity (cu. in.)	Description	Std. Ctn.
53	14.0	Two 1/2" KOs in each side, one 1/2" KO in each end and two 1/2" KOs in bottom. Furnished with plaster ears. Four nail holes in sides*	50
53-3/4-BW	14.0	Two 1/2" KOs in each side, one 1/2" KO in each end and two 1/2" KOs in bottom. Furnished with plaster ears. Four nail holes in sides*	50
53-NE	14.0	Two 1/2" KOs in each side, one 1/2" KO in each end and two 1/2" KOs in bottom. Four nail holes in sides*	50
53-NE-3/4	14.0	Two 1/2" KOs in each side, one 3/4" KO in each end and two 1/2" KOs in bottom. Four nail holes in sides*	50
53-LCNE	14.0	For non-metallic cable, 2³/₄" deep x 3" long x 2" wide Two 1/2" KOs in each side, two loom KOs and one 1/2" KO in each end and one 1/2" KO in bottom. One loom clamp for use on non-metallic sheathed cable with 10/32 deep-slotted screw assembled. Four nail holes in sides*	50
53-FB	14.0	Two 1/2" KOs in one side, flat bracket on other side, one 1/2" KO in each end and two 1/2" KOs in bottom. Flat bracket offset 9/16" from face*	50
53-FBC	14.0	For non-metallic cable, 2³/₄" deep x 3" long x 2" wide Two 1/2" KOs in one side, flat bracket on other side, two loom KOs and one 1/2" KO in each end and one 1/2" KO in bottom. Flat offset 9/16" from face. One loom clamp for use on non-metallic sheathed cable with 10/32 deep-slotted screw assembled*	50
53-FB-MXN	14.0	For metal clad cable, 2³/₄" deep x 3" long x 2" wide Two 1/2" KOs in one side, flat bracket on other side, two loom KOs and one 1/2" KO in each end, and one 1/2" KO in bottom. One MXN clamp for MC, AC/BX, and non-metallic sheathed cable (NM) included with 10/32 deep-slotted screw. Clamp is UL Listed for use with cable sizes 14/2 through 10/3 with ground*	50
53-OWEC	14.0	For non-metallic cable, 2³/₄" deep x 3" long x 2" wide Two 1/2" KOs in each side, two loom KOs and one 1/2" KO in each end and one 1/2" KO in bottom. Furnished with plaster ears. One loom clamp for use on non-metallic sheathed cable with 10/32 deep-slotted screw assembled. With old-work swing brackets*	50
53-OWE	14.0	Two 1/2" KOs in each side, one 1/2" KO in each end and two 1/2" KOs in bottom. Furnished with plaster ears. With old-work swing brackets*	50
53-OWE-MXN	14.0	For metal clad cable, 2³/₄" deep x 3" long x 2" wide Two 1/2" KOs in each side. Two loom KOs and one 1/2" KO in each end and one 1/2" KO in bottom. One MXN clamp for MC, AC/BX and non-metallic sheathed cable (NM) included with 10/32 deep-slotted screw. Clamp is UL Listed for use with cable sizes 14/2 through 10/3 with ground. Furnished with plaster ears. With old-work swing brackets*	50

*Uses Steel City® 100 series covers.

Switch boxes and accessories

Gangable switch boxes - 3 1/2" deep

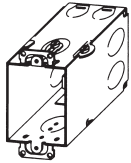

54-LC

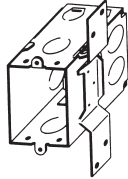

54-FBC

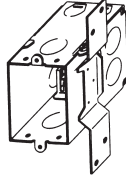

54-FB-MXN

Gangable switch boxes - 3 1/2" deep

Cat. No.	Capacity (cu. in.)	Description	Std. Ctn.
54-LC	18.0	For non-metallic cable, 3 1/2" deep x 3" long x 2" wide Two 1/2" KOs in each side, two loom KOs and one 1/2" KO in each end and one 1/2" KO in bottom. Two loom clamps for use on non-metallic sheathed cable with 10/32 deep-slotted screws assembled. Furnished with plaster ears. Four nail holes in sides*	50
54-FBC	18.0	For non-metallic cable, 3 1/2" deep x 3" long x 2" wide Two 1/2" KOs in one side, flat bracket and two 1/2" KOs in other side, two loom KOs and one 1/2" KO in each end and one 1/2" KO in bottom. Two loom clamps for use on non-metallic sheathed cable with 10/32 deep-slotted screws assembled. Flat bracket offset 9/16" from face*	50
54-FB-MXN	18.0	For metal clad cable, 3 1/2" deep x 3" long x 2" wide Two 1/2" KOs in one side, flat bracket and two 1/2" KOs in other side, two loom KOs and one 1/2" KO in each end and one 1/2" KO in bottom. Two MXN clamps for MC, AC/BX, and non-metallic sheathed cable (NM) included with 10/32 deep-slotted screws. Clamps are UL Listed for use with cable sizes 14/2 through 10/3 with ground. Flat bracket offset 9/16" from face*	50

*Uses Steel City® 100 series covers.

Welded non-gangable switch boxes - 2 1/2" deep

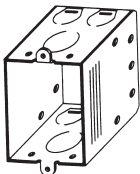

72

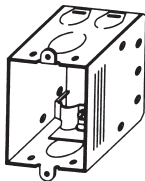

72-C

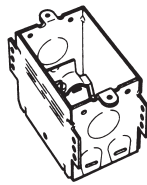

72-OC

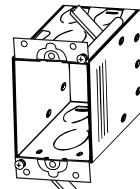

72-OWE

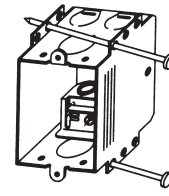

72-ONS-MXN

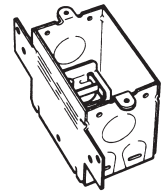

72-FB-MXN

Gangable switch boxes - 2 1/2" deep

Cat. No.	Capacity (cu. in.)	Description	Std. Ctn.
72	12.5	2 1/2" deep x 3" long x 2" wide Two loom KOs and one 1/2" KO in each end and one 1/2" KO in bottom. Four nail holes included*	50
72-C	12.5	For non-metallic cable, 2 1/2" deep x 3" long x 2" wide Two loom KOs and one 1/2" KO in each end and one 1/2" KO in bottom. Four nail holes included. One loom clamp for use on non-metallic sheathed cable with 10/32 deep-slotted screw assembled*	50
72-OC	12.5	For non-metallic cable, 2 1/2" deep x 3" long x 2" wide Two loom KOs and one 1/2" KO in each end and one 1/2" KO in bottom. One loom clamp for use on non-metallic sheathed cable with 10/32 deep-slotted screw assembled. Four nail holes included. Provisions for external nails included*	50
72-OWE	12.5	2 1/2" deep x 3" long x 2" wide Two loom KOs and one 1/2" KO in each end and one 1/2" KO in bottom. With old-work swing brackets*	50
72-ONS-MXN	12.5	For metal clad cable, 2 1/2" deep x 3" long x 2" wide Two loom KOs and one 1/2" KO in each end and one 1/2" KO in bottom. One MXN clamp for MC, AC/BX and non metallic sheathed cable (NM) included with 10/32 deep-slotted screw. Clamp is UL Listed for use with cable sizes 14/2 through 10/3 with ground. Four nail holes included. Two 16-penny nails swaged at an angle in box*	50
72-FB-MXN	12.5	For metal clad cable, 2 1/2" deep x 3" long x 2" wide Two loom KOs and one 1/2" KO in each end, one 1/2" KO in bottom and flat bracket on one side offset 9/16" from face. Two MXN clamps for MC, AC/BX and non-metallic sheathed cable (NM) included with 10/32 deep-slotted screws. Clamps are UL Listed for use with cable sizes 14/2 through 10/3 with ground. Four nail holes included*	50

*Uses Steel City® 100 series covers.

Switch boxes and accessories

Welded non-gangable switch boxes - 2¹³/₁₆" deep

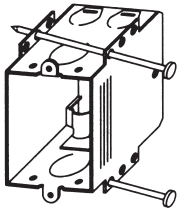

73-ONCS

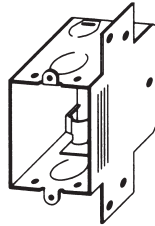

73-FBC

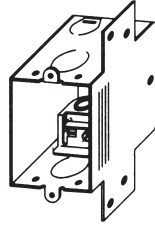

73-FB-MXN

Welded non-gangable switch boxes - 2¹³/₁₆" deep

Cat. No.	Capacity (cu. in.)	Description	Std. Ctn.
73-ONCS	15.8	For non-metallic cable, 2¹³/₁₆" deep x 3" long x 2⁹/₆₄" wide Two loom KOs and one 1/2" KO in each end and one 1/2" KO in bottom. One loom clamp for use on non-metallic sheathed cable with 10/32 deep-slotted screw assembled. Two 16-penny nails swaged at an angle in box*	50
73-FBC	15.8	For non-metallic cable, 2¹³/₁₆" deep x 3" long x 2⁹/₆₄" wide Two loom KOs and one 1/2" KO in each end, one 1/2" KO in bottom and flat bracket on one side offset 9/16" from face. One loom clamp for use on non-metallic sheathed cable with 10/32 deep-slotted screw assembled. Four nail holes included*	50
73-FB-MXN	15.8	For metal clad cable, 2¹³/₁₆" deep x 3" long x 2⁹/₆₄" wide Two loom KOs and one 1/2" KO in each end, one 1/2" KO in bottom and flat bracket on one side offset 9/16" from face. One MXN clamp for MC, AC/BX and non-metallic sheathed cable (NM) included with 10/32 deep-slotted screw. Clamp is UL Listed for use with cable sizes 14/2 through 10/3 with ground. Four nail holes included*	50

*Uses Steel City® 100 series covers.

Welded non-gangable switch boxes - 3" deep

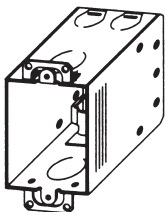

74-CE

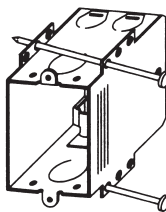

74-ONCS

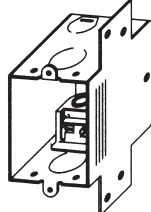

74-FBC

Welded non-gangable switch boxes - 3" deep

Cat. No.	Capacity (cu. in.)	Description	Std. Ctn.
74-CE	18	For non-metallic cable, 3¹/₈" deep x 3" long x 2¹/₄" wide Two loom KOs and one 1/2" KO in each end and one 1/2" KO in bottom. One loom clamp for use on non-metallic sheathed cable with 10/32 deep-slotted screw assembled. Furnished with ears. Four nail holes included*	50
74-ONCS	18	For non-metallic cable, 3¹/₈" deep x 3" long x 2¹/₄" wide Two loom KOs and one 1/2" KO in each end and one 1/2" KO in bottom. One loom clamp for use on non-metallic sheathed cable with 10/32 deep-slotted screw assembled. Two 16-penny nails swaged at an angle in box*	50
74-FBC	18	For non-metallic cable, 3¹/₈" deep x 3" long x 2¹/₄" wide Two loom KOs and one 1/2" KO in each end, one 1/2" KO in bottom and flat bracket on oneside offset 9/16" from face. One loom clamp for use on non-metallic sheathed cable with 10/32 deep-slotted screw assembled. Four nail holes included*	50

*Uses Steel City® 100 series covers.

Switch boxes and accessories

Welded non-gangable switch boxes - $3\frac{13}{32}$ " deep

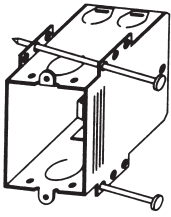

75-ONCS

Welded non-gangable switch boxes - $3\frac{13}{32}$ " deep

Cat. No.	Capacity (cu. in.)	Description	Std. Ctn.
75-ONCS	20.0	For non-metallic cable, $3\frac{13}{32}$" deep x 3" long x $2\frac{1}{4}$" wide Two loom KOs and one $\frac{1}{2}$ " KO in each end and one $\frac{1}{2}$ " KO in bottom. Two loom clamp for use on non-metallic sheathed cable with 10/32 deep-slotted screw assembled. Four nail holes included. Two 16-penny nails swaged at angle in box*	50

*Uses Steel City® 100 series covers.

Welded multi-gangable switch boxes - $2\frac{1}{2}$ " deep

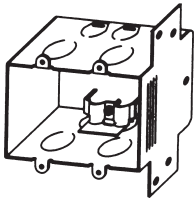

271-FBC

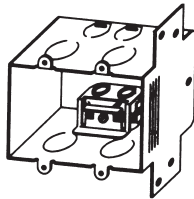

271-FB-MXN

Welded multi-gangable switch boxes - $2\frac{1}{2}$ " deep

Cat. No.	Capacity (cu. in.)	Description	Std. Ctn.
271-FBC	25.0	A two-gang box – for non-metallic cable, $2\frac{1}{2}$" deep x 3" long x 4" wide Two loom KOs and two $\frac{1}{2}$ " KOs in each end, flat bracket on one side and one $\frac{1}{2}$ " KO in bottom. Two Loom clamps for use on non-metallic sheathed cable with 10/32 deep-slotted screws assembled. Flat bracket offset $\frac{9}{16}$ " from face*	25
271-FB-MXN	25.0	A two-gang box – for metal clad cable, $2\frac{1}{2}$" deep x 3" long x 4" wide Two loom KOs and two $\frac{1}{2}$ " KOs in each end, flat bracket on one side and one $\frac{1}{2}$ " KO in bottom. Two MXN clamps for MC, AC/BX and non-metallic sheathed cable (NM) included with 10/32 deep-slotted screws. Clamps are UL Listed for use with cable sizes 14/2 through 10/3 with ground. Flat bracket offset $\frac{9}{16}$ " from face*	25

*Uses Steel City® SB-2 covers.

Switch boxes and accessories

4 x 2¹/₁₆" Thru-wall box



4" x 2¹/₁₆" Thru-wall box - with conduit KOs for plaster or dry wall

Cat. No.	Capacity (cu. in.)	Description	Box Depth (in.)	Std. Ctn.
CTDW	32.0	Drywall, partition type; one 1/2" and one 3/4" KO both ends; one 1/2" KO on one side, V bracket other side	4 ⁵ / ₁₆	25

Switch box extension

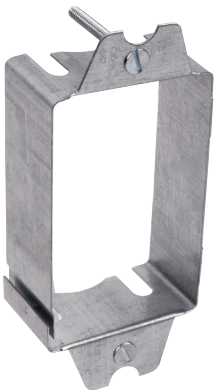

Switch box extension

Cat. No.	Description	Std. Ctn.
SBEX	Cubic content 3.5 inches; fits snugly inside of all single-gang switch boxes; maximum adjustable depth 7/8"; furnished with 1 ¹ / ₄ "-long screws for mounting	50

UL Listing not applicable — subject to approval by local inspector.

Switch boxes and accessories

Old-work box support

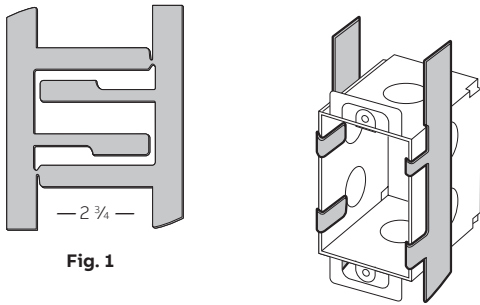

Fig. 1

Features and benefits:

- Quickly attaches box through finished drywall
- For up to 1½" thick drywall
- New 820D shipped in one piece break-apart design
- Easy to install

Old-work box support

Cat. No.	Fig. No.	Description	Std. Ctn.
820D	1	Old-work switch box steel-mounting holder	500 sets

Steel low-voltage bracket

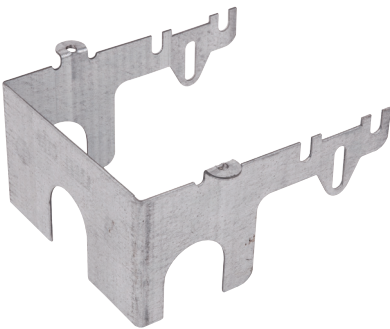

Features and benefits:

- Fixes to the switch box easily with the screws provided
- Works with any Steel City® switch box, regardless of depth
- Single-screw fixing as well as two-screw fixing
- Low-voltage cable support is provided by fitting location tabs
- UL Listed for low-voltage support

Steel low-voltage bracket

Cat. No.	Description	Box Depth (in.)	Std Ctn.
LVB	Bracketed to T&B boxes; provides means of installing a low-voltage device alongside a regular switch or outlet	1½	25

Old-work box support clips

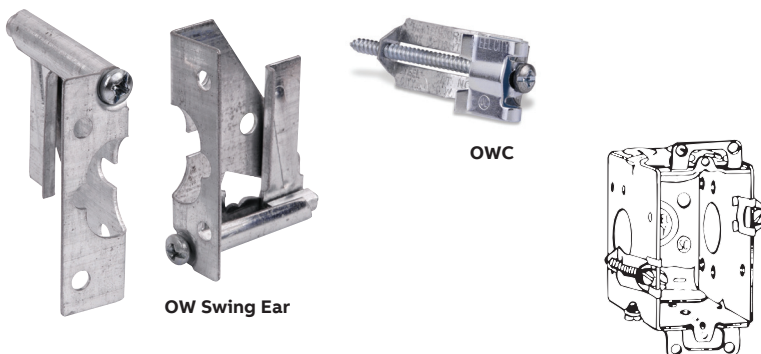

OW Swing Ear

OWC

Features and benefits:

- Adapts to any wall thickness up to ¾"



Old-work box support clips

Cat. No.	Description	Std Ctn.
OWC	Clips lock old-work steel switch boxes tightly to wall plaster, drywall, concrete block, brick or concrete. 2 required per box, (1 set)	250 sets
OW Swing Ear	Swing ears only (for field installations) with self-threading screws	50 (25 pair)

Round/octagon boxes and accessories

4" Round boxes

4" Round boxes - with conduit KOs

Cat. No.	Depth (in.)	Capacity (cu. in.)	Description	Knockouts		Std. Ctn.
				Conduit Bottom		
 56111	1/2	6.0	Steel outlet box	4-1/2		50
 56111-CFB*	1/2	6.0	Ceiling fan box with plastic Romex connector included. NC501-SC	2-1/2		10

*Meets NEC® 314.27(c) up to 35 lb. fan.
 56111-CFB is shipped with plastic cover and all hardware.
 50 lb. maximum loading for fixtures.
 NEC and National Electrical Code are registered trademarks of the National Fire Protection Association, Inc.

4" Pancake boxes



4" Pancake boxes

Cat. No.	Capacity (cu. in.)	Description	Std. Ctn.
 410-LC	5.8	For Non-Metallic Sheathed Cable, 4" diameter – 1/2" deep Three 1/2" KOs in a line and four loom KOs at opposite ends in bottom. Furnished with two loom clamps for non-metallic cable with 10/32 deep-slotted screws and two 8/32 x 1/2" screws in ears*	50

*Uses Steel City® 500 series covers.
 50 lb. maximum loading for fixtures.

3 1/2" Round boxes

3 1/2" Round boxes - with non-metallic sheathed cable clamps

Cat. No.	Depth (in.)	Capacity (cu. in.)	Clamps	Knockouts (in.)		Std. Ctn.
				Bottom Conduit	Cable	
 36115 C30	1/2	4.0	C-8	1-1/2	4	30
 36125 D	3/4	4.0	C-10	1-1/2	4	25

36115 C30 Cover screws supplied
 36125 D Cover screws supplied

50 lb. maximum loading for fixtures.

Round/octagon boxes and accessories

3 1/4" Pancake boxes

3 1/4" Pancake boxes

	Cat. No.	Capacity (cu. in.)	Description	Std. Ctn.
	210-L	4.0	For non-metallic sheathed cable, 3 1/4" diameter – 1/2" deep. Three 1/2" KOs in a line with four loom KOs at opposite ends in bottom. Furnished with two 8/32 x 1/2" screws*	100

*Uses Steel City® 300 series covers.
50 lb. maximum loading for fixtures.

Covers for 3 1/2" round and octagon boxes

Covers for 3 1/2" round and octagon boxes

	Cat. No.	Description	Std. Ctn.
	24C1-25	Flat, blank	100
	24-C-6	Flat with 1/2" KO	25

24C1-25

24-C-6

Round/octagon boxes and accessories

3½" Octagon boxes



241511/2-25



25151 1/2



24151N-25

24151-NV
V bracket recessed ½"

3½" Octagon boxes

Cat. No.	Depth (in.)	Capacity (cu. in.)	Clamps	Ea. side Clamps	Ea. side Conduit	Ea. end Conduit	Knockouts (in.)		Std. Ctn.
							Ea. end Cable	Bottom Conduit	
With conduit KOs									
241511/2-25	1½	11.8	–	–	1-½	1-½	–	1-½	50
25151 1/2	1½	11.8	–	–	1-½	1-½	–	–	50
With non-metallic sheathed cable clamps									
24151N-25	1½	11.8	C-5	–	1-½	–	2	1-½	50
24151-NV	1½	11.8	C-5	–	1-½	–	2	1-½	50

50 lb. maximum loading for fixtures.

3½" Octagon boxes

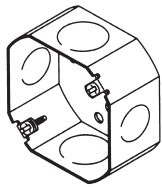

3-O-SPL



3-O-LCE



3-O-B-1/2

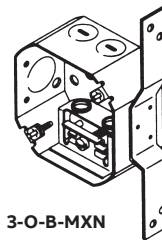

3-O-B-MXN

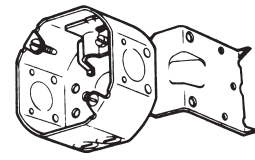

3-O-LCH

3½" Octagon boxes

Cat. No.	Depth (in.)	Capacity (cu. in.)	Description	Construction Type	Std. Ctn.
3-O-SPL	1½	11.8	One ½" KO in each of two opposite sides, one ¾" KO in other two sides and one ½" KO in bottom*	Drawn	50
3-O-LCE	1½	11.8	For non-metallic sheathed cable Two loom KOs in each of two opposite sides, two ½" KOs in other two sides and one ½" KO in bottom. Two ears, one on each of two opposite sides. Two loom clamps for use on non-metallic sheathed cable with 10/32 deep-slotted screws assembled*	Drawn	50
3-O-B-1/2	1½	11.8	One ½" KO in each of three sides, flat bracket on fourth side, with one ½" KO in bottom. Flat bracket offset ½" from face*	–	50
3-O-B-MXN	1½	11.8	For metal-clad cable Two loom KOs in each of two opposite sides, one ½" KO in side opposite bracket and one ½" KO in bottom. Two MXN clamps for MC, AC/BX and non-metallic sheathed cable (NM) included with 10/32 deep-slotted screws. Clamps are UL Listed for use with cable sizes 14/2 through 10/3 with ground. Flat bracket offset ½" from face*	Drawn	50
3-O-LCH	1½	11.8	For non-metallic sheathed cable Two loom KOs in each of two opposite sides, one ½" KO in other two sides and one ½" KO in bottom. Two loom clamps for use on non-metallic sheathed cable with 10/32 deep-slotted screws assembled. Hanger bracket for overhead work*	Drawn	50

*Uses Steel City® 3½" octagonal extension rings and 300 series rings and covers.
50 lb. maximum loading for fixtures.

Round/octagon boxes and accessories

4" Octagon boxes



54151 N



54151 NE Adjustable ears recessed 5/8"

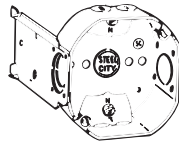

54151 NL L bracket flush mounted

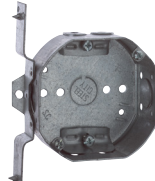

54151 NV V bracket recessed 1/2"

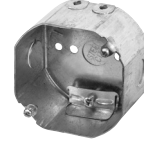

54171N-25



54171 NL L bracket mounted flush



54171NV-25 V bracket recessed 1/2"



54151 1/2



54151 3/4



54151 1/2 & 3/4

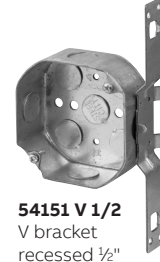

54151 V 1/2 V bracket recessed 1/2"



54151 L 1/2 L bracket mounted flush



54151 J 1/2 Mounted on 6010-DW bar adjustable 10 1/2" to 18 1/2". Offset for 1/2", 3/4" or 7/8" plaster. Maximum horizontal positioning. 3/8" fixture stud.



541711/2-25



54171 1/2 3/4

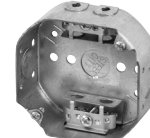

54151 A



54171 3/4



54171 1



54151AV-25 V bracket recessed 1/2"



54151 AL L bracket mounted flush

4" Octagon boxes

Cat. No.	Depth (in.)	Capacity (cu. in.)	Clamps	Brackets	Ea. side Conduit	Ea. end Conduit	Knockouts (in.)		Std. Ctn.
							Ea. end Cable	Bottom Conduit	
With non-metallic sheathed cable clamps									
54151 N	1 1/2	15.8	C-5	–	1-1/2	–	2	1-1/2	50
54151 NE	1 1/2	15.8	C-5	–	1-1/2	–	2	1-1/2	50
54151 NL	1 1/2	15.8	C-5	L	1-1/2	–	2	1-1/2	50
54151 NV	1 1/2	15.8	C-5	V	1-1/2	–	2	1-1/2	50
54171N-25	2 1/8	22.5	C-5	–	1-1/2	–	2	1-1/2	50
54171 NL	2 1/8	22.5	C-5	L	1-1/2	–	2	1-1/2	50
54171NV-25	2 1/8	22.5	C-5	V	1-1/2	–	2	1-1/2	25
With conduit KOs									
54151 1/2	1 1/2	15.8	–	–	1-1/2	1-1/2	–	5-1/2	50
54151 3/4	1 1/2	15.8	–	–	1-3/4	1-3/4	–	3-1/2 2-3/4	50
54151 1/2 & 3/4	1 1/2	15.8	–	–	1-1/2	1-3/4	–	3-1/2 2-3/4	50
54151 V 1/2	1 1/2	15.8	–	V	1-1/2	1-1/2	–	5-1/2	25
54151 L 1/2	1 1/2	15.8	–	L	1-1/2	1-1/2	–	5-1/2	25
54151 J 1/2	1 1/2	15.8	–	With bar hanger	1-1/2	1-1/2	–	4-1/2	25
541711/2-25	2 1/8	22.5	–	–	1-1/2	1-1/2	–	5-1/2	50
54171 3/4	2 1/8	22.5	–	–	1-3/4	1-3/4	–	3-1/2	25
54171 1/2 3/4	2 1/8	22.5	–	–	1-1/2	1-3/4	–	3-1/2	25
54171 1	2 1/8	22.5	–	–	1-1	1-1	–	3-1/2 2-3/4	25
With armored cable/metal-clad clamps									
54151 A	1 1/2	15.8	C-3	–	1-1/2	–	2	1-1/2	25
54151AV-25	1 1/2	15.8	C-3	V	1-1/2	–	2	1-1/2	50
54151 AL	1 1/2	15.8	C-3	L	1-1/2	–	2	1-1/2	25

50 lb. maximum loading for fixtures.

Round/octagon boxes and accessories

4" Octagon boxes (continued)



54151 NF
Octagon box mounted on adjustable bar hanger. 50 lb. load max rating.

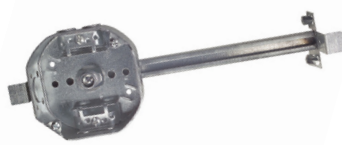

54151 AF
Octagon box mounted on adjustable bar hanger. 50 lb. load max rating.

4" Octagon boxes

Cat. No.	Depth (in.)	Capacity (cu. in.)	Bar Hanger Number	Bar Length (in.)	Offset for	Stud (in.)	Std. Ctn.
For non-metallic sheathed cable							
54151 NF	1½	15.8	6010-DW	10½-18½	–	¾	25
54151 NO	1½	15.8	6010-ADW	14½-26½	–	¾	25
54151 NG	1½	15.8	6011-DW	10½-18½	–	Fastener	25
54151 NP	1½	15.8	6011-ADW	14½-26½	–	Fastener	25
For armored cable/metal-clad							
54151 AF	1½	15.8	6010-DW	10½-18½	Drywall	¾	25

50 lb. maximum loading for fixtures.

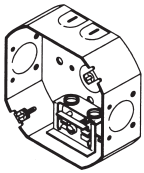

4-OW-MXN

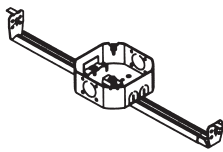

4-OW-LC-BHC

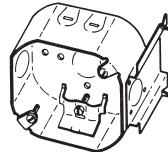

4-O-ULC

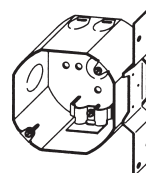

4-OD-LCB

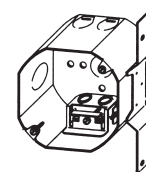

4-OD-FB-MXN

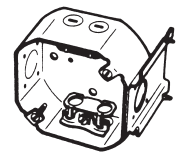

4-OD-U-MXN

4" Octagon boxes

Cat. No.	Depth (in.)	Capacity (cu. in.)	Description	Construction Type	Std. Ctn.
4-OW-MXN	1½	15.5	For metal-clad cable Two Loom KOs in each of two opposite sides, one ½" KO in other two sides and one ½" KO in bottom. Two MXN clamps for MC, AC/BX and non-metallic sheathed cable (NM) included with 10/32 deep-slotted screws. Clamps are UL Listed for use with cable sizes 14/2 through 10/3 with ground*	Welded	50
4-OW-LC-BHC	1½	15.5	For non-metallic sheathed cable Two loom KOs in each of two opposite sides, one ½" KO in other two sides. Box mounted with clip to adjustable hanger. Two loom clamps for use on non-metallic sheathed cable with 10/32 deep-slotted screws assembled*	Welded	25
4-O-ULC	1½	15.5	For non-metallic sheathed cable Two loom KOs in each of two opposite sides, ½" KOs in other two sides and one ½" KO in bottom. Two loom clamps for use on non-metallic sheathed cable with 10/32 deep-slotted screws assembled. U bracket for overhead work*	Drawn	50
4-OD-LCB	2⅛	21.5	For non-metallic sheathed cable Two loom KOs in each of two opposite sides, one ½" KO in side opposite bracket and one ½" KO in bottom. Two loom clamps for use on non-metallic sheathed cable with 10/32 deep-slotted screws assembled. Flat bracket offset ½" from face*	Drawn	25
4-OD-FB-MXN	2⅛	21.5	For metal-clad cable Two loom KOs in each of two opposite sides, one ½" KO in side opposite bracket and one ½" KO in bottom. Two MXN clamps for MC, AC/BX and non-metallic sheathed cable (NM) included with 10/32 deep-slotted screws. Clamps are UL Listed for use with cable sizes 14/2 through 10/3 with ground. Flat bracket offset ½" from face*	Drawn	25
4-OD-U-MXN	2⅛	21.5	For metal-clad cable Two loom KOs in each of two opposite sides, one ½" KO in other two sides and one ½" KO in bottom. Two MXN clamps for MC, AC/BX and non-metallic sheathed cable (NM) included with 10/32 deep-slotted screws. Clamps are UL Listed for use with cable sizes 14/2 through 10/3 with ground. U bracket for overhead work*	Drawn	25

Uses Steel City® 4" octagonal extension rings and 500 series rings and covers. 50 lb. maximum loading for fixtures.

Round/octagon boxes and accessories

3" Octagon box covers

3" Octagon box covers

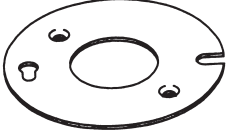
	Cat. No.	Description	Std. Ctn.
	300-DR	Flat — 3½" diameter For duplex receptacle in center. Screw-hole countersunk*	25
	300-SR	Flat — 3½" diameter For single receptacle in center. Opening 1.4" in diameter. Screw-holes countersunk*	25

*Fits any Steel City® 300 3" octagonal outlet box or extension ring.

4" Round and Octagon box covers

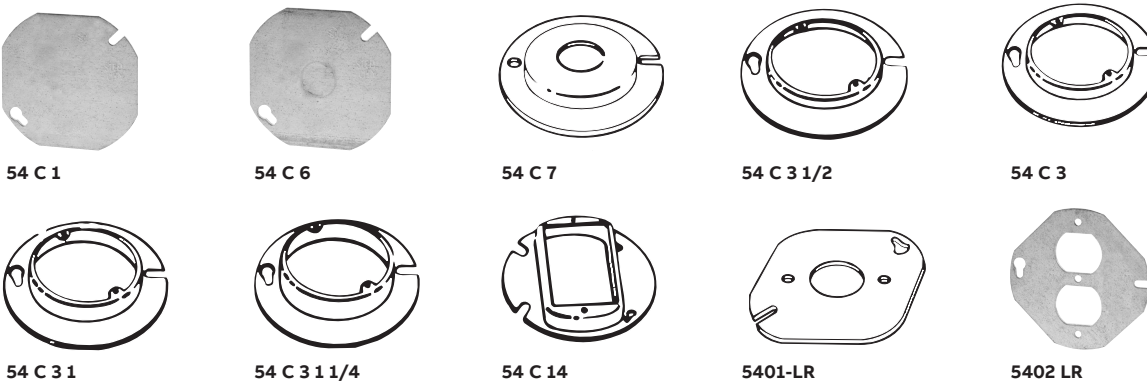

4" Round and octagon box covers



Cat. No.	Raised (in.)	Description	Capacity (cu. in.)	Std. Ctn.
54 C 1	–	Flat, blank	–	50
54 C 6	–	Flat, with ½" KO	–	50
54 C 7	5/8	With ½" KO	3.5	25
54 C 3 1/2	1/2	Center blanked with tapped ears on 2¾" centers	3.0	25
54 C 3	5/8	Center blanked with tapped ears on 2¾" centers	3.5	25
54 C 3 1	1	Center blanked with tapped ears 2 ²³ / ₃₂ " centers	5.8	25
54 C 3 1 1/4	1¼	Center blanked with tapped ears 2 ²³ / ₃₂ " centers	7.3	25
54 C 14	5/8	For single device	3.5	25
5401-LR	–	Flat, center blanked for single receptacle – 1 13/32" dia. hole	–	25
5402-LR	–	Flat, center blanked for duplex receptacle	–	25

For swivel covers, see accessories section on page 44.

Round/octagon boxes and accessories

4" Octagon box extension rings

4" Octagon box extension rings - with conduit KOs

Cat. No.	Depth (in.)	Capacity (cu. in.)	Knockouts (in.)		Std. Ctn.
			Ea. side Conduit	Ea. end Conduit	
 551511/2-25	1½	15.8	1-½	1-½	50
 55151 1/2 3/4	1½	15.8	1-½	1-¾	25

4" Octagon box extension rings

4" Octagon box extension rings

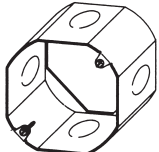
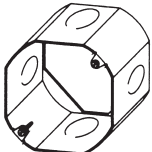
Cat. No.	Depth (in.)	Capacity (cu. in.)	Description	Construction Type	Std. Ctn.
 4-OD-EXT-1/2	2⅛	21.5	Extension Ring One ½" KO in each of four sides*	Drawn	25
 4-OD-EXT-SPL	2⅛	21.5	Extension Ring One ½" KO in each of two opposite sides and one ¾" KO in other two sides*	Drawn	25

*Uses Steel City® 4" octagonal outlet boxes and 500 series rings and covers.

4" Octagon box extension rings

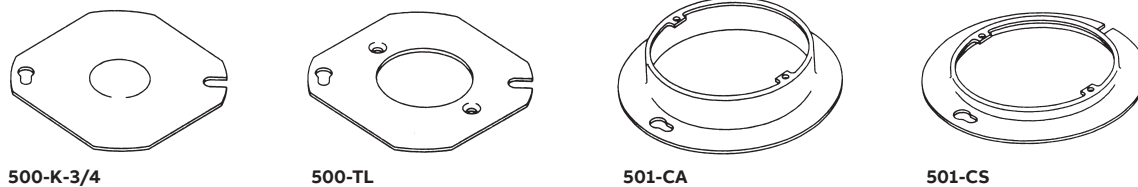

4" Octagon boxes

Cat. No.	Capacity (cu. in.)	Description	Std. Ctn.
500-K-3/4	-	Flat – 4" octagonal One ¾" KO in center*	50
500-TL	-	Flat – 4" octagonal Four-wire twistlock in center. Screw holes countersunk. Opening 1.594" diameter*	25
501-CA	4.5	¾" raised — 4" diameter Open plaster ring with ears. Ears tapped 8/32–2 ²³ /32" on centers. Special screw-lock feature in slots*	25
501-CS	1.5	¼" raised — 4" diameter Open plaster ring with ears. Ears tapped 8/32–2 ²³ /32" on centers. Special screw-lock feature in slots*	25

*Fits any Steel City® 4" octagonal outlet box or extension ring.

Ceiling fan boxes and accessories

Steel and non-metallic boxes and bar hangers for fan and fixture installation

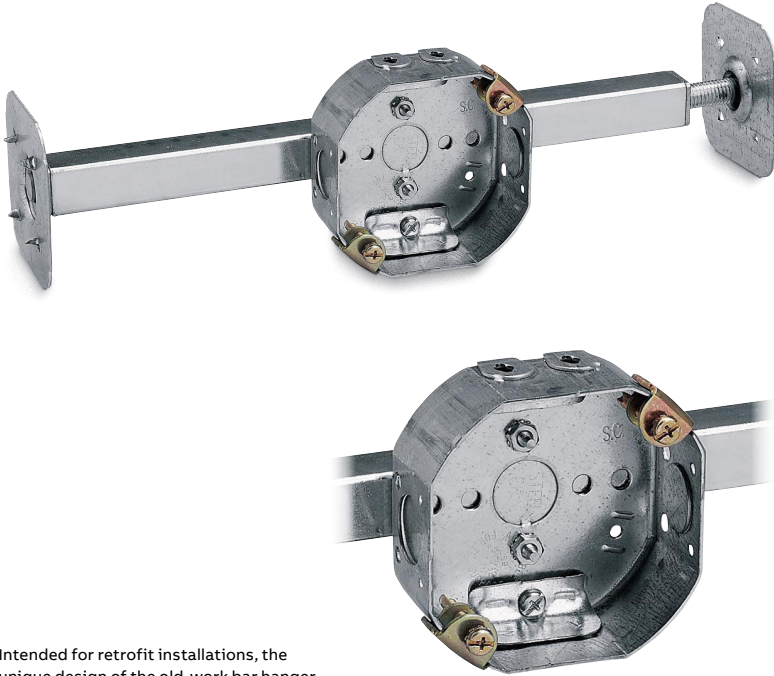

Intended for retrofit installations, the unique design of the old-work bar hanger ensures a trouble-free installation that surpasses the competition.

NEC and National Electrical Code are registered trademarks of the National Fire Protection Association, Inc.

Fan and fixture support

Exhaustive research and development has resulted in an innovative line of ceiling fan support boxes that give Steel City® the competitive advantage. Ceiling fan and fixture installation is faster, easier and safer with Steel City® ceiling fan support boxes.

Features and benefits:

- Gold finish on ears/screws easily identifies boxes as meeting UL and NEC® requirements for fan support
- UL Listed up to 50 lbs for fixture and 35 lbs for fan
- Each box comes complete with instructions and installation hardware

Ceiling fan and light fixture bar hanger

- Square end plates keep the bar parallel with sheetrock
- Square section tube is easy to grip, allowing high torque for safe installation
- UL Listed up to 50 lbs for fixture and 35 lbs for fan
- Expandable for joists spaced from 16 to 24 inches

Ceiling fan and light fixture bar hanger

Cat. No.	Capacity (cu. in.)	Description	New/Old Work	Std. Ctn.
54151CFB-BHL-OW	15.8	Old-work bar hanger with 1½" deep ceiling fan box with 3 x ½" KOs and clamps for non-metallic sheathed cable	Old	10

Max rec. loads 35 lbs fan and 50lbs fixture.

Ceiling fan boxes and accessories

Steel and non-metallic boxes and bar hangers for fan and fixture installation

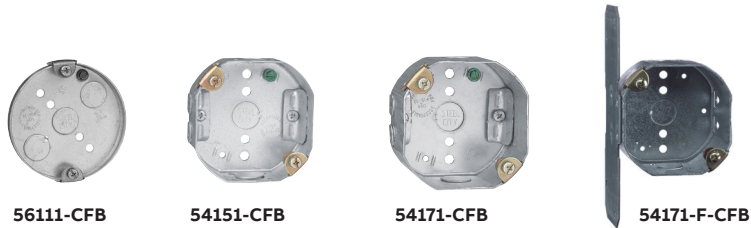

Ceiling fan support boxes

Cat. No.	Capacity (cu. in.)	Description	Dimensions		New/Old Work	Std. Ctn.
			Diameter (in.)	Depth (in.)		
56111-CFB	6.0	Pan type ceiling fan box with 3 x 1/2" KOs and non-metallic sheathed cable connector	4	1/2	Both	10
54151-CFB	15.8	1 1/2" deep ceiling fan box with 3 x 1/2" KOs and clamps for non-metallic sheathed cable	4	1 1/2	New	10
54151-1/2-CFB-BP	15.8	1 1/2" deep ceiling fan box with 5 x 1/2" KOs. Bulk pack	4	1 1/2	New	50
54171-CFB	22.0	2 1/8" deep ceiling fan box with 3 x 1/2" KOs and clamps for non-metallic sheathed cable	4	2 1/8	New	10
54171-F-CFB*	22.0	As 54171-CFB, but with "F" style mounting bracket	4	2 1/8	New	10
54171-1/2-F-CFB-BP	22.0	2 1/8" deep ceiling fan box with 5 x 1/2" KOs and "F" style mounting bracket	4	2 1/8	New	50

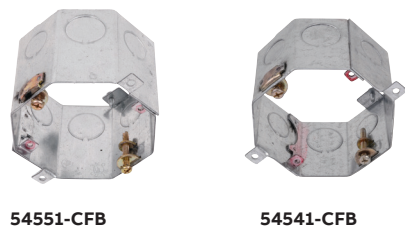

Cat. No.	Clamps	Ears	Brackets	Knockouts (in.)				Std. Ctn.
				Ea. side Conduit	Ea. end Conduit	Ea. end Cable	Bottom Conduit	
54541-CFB	2 1/2 DP	-	Concrete ring	1/2-3/4	-	-	-	50
54551-CFB	3 DP	-	Concrete ring	1/2-3/4	-	-	-	50

Max. loads 35 lbs. fan and 50 lbs. fixture.

Cover — CBP or CBP-3/8. 35# fan rating, 50# fixture rated.

* Maximum load for 54171-F-CFB is 70 lbs. fan and 200 lbs. fixture.

Ceiling fan boxes and accessories

Ceiling fan and light fixture bar hangers



Extra heavy-duty new-work bar hangers

This innovative extruded-aluminum bar hanger was designed for strength. It is UL Listed for up to 70 lbs for fan support and an industry leading 200 lbs for fixture support.

Features and benefits:

- Gold end plates easily identify the hanger as meeting UL and NEC® requirements for fan support
- Screwed-on end plates are consistently strong and avoid unsightly welds
- End plates feature temporary fixing spikes for hands-free installation
- Expandable for joists spaced from 16 to 24 inches

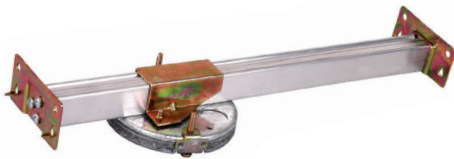

56111CFB-BHL

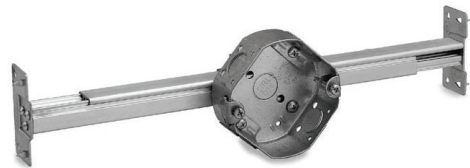

54151CFB-BHL



4070CFB-BHL



CFB-BHL

Ceiling fan and light fixture bar hanger

Cat. No.	Capacity (cu. in.)	Description	Max. Rec. Load		New/Old Work	Std. Ctn.
			Fan	Fixture		
56111CFB-BHL	6.0	New-work bar hanger with 1/2" pan-type ceiling fan box with 3 x 1/2" KOs and non-metallic sheathed cable connector	70 lbs	200 lbs	New	10
54151CFB-BHL	15.8	New-work bar hanger with 1 1/2" deep ceiling fan box with 3 x 1/2" KOs and clamps for non-metallic sheathed cable	70 lbs	200 lbs	New	10
4070CFB-BHL	21.5	New-work bar hanger with non-metallic ceiling fan box with clamps for non-metallic sheathed cable	35 lbs	50 lbs	New	10
CFB-BHL	*	New-work bar hanger without outlet box. Mounting bracket for outlet box included	-	*	New	10

* Dependent on box used.
NEC and National Electrical Code are registered trademarks of the National Fire Protection Association, Inc.

Square boxes and accessories

Fire alarm boxes and fittings

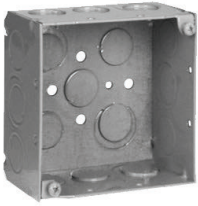

52171-1234RD



72171-1234RD



52171-EXTRD



52-C-1RD



52151-1234RD

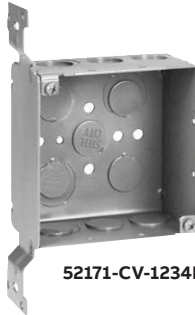

52171-CV-1234RD

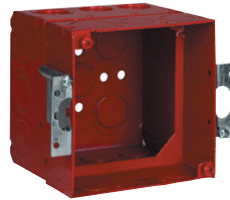

52171-EXTOWRD

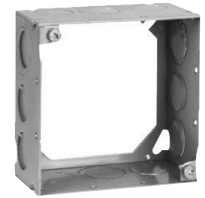

53171-1234RD

Easy to identify and install!

Steel City® fire alarm boxes and fittings can meet all of your visual identification requirements for fire alarm systems – and make installation and upgrades faster and easier than ever before! Available in a variety of sizes to accommodate new or old work configurations, these boxes are simple to install with high-quality Steel City® fittings. Plus, the bright red finish eliminates time-consuming painting of existing fixtures and provides long-lasting identification in even the harshest environments.

Fire alarm boxes

Cat. No.	Description	Ears	Brackets	Each side Conduit	Each end Conduit	Bottom Conduit	Capacity (cu. in.)	Std. Ctn.
52171-1234RD	2 ¹ / ₈ "-deep 4"-square red box	-	-	2 ¹ / ₂ ", 1 ¹ / ₂ " & 3/4"E	2 ¹ / ₂ ", 1 ¹ / ₂ " & 3/4"E	3 ¹ / ₂ ", 2 ¹ / ₂ " & 3/4"E	30.3	50
52151-1234RD	1 ¹ / ₂ "-deep 4"-square drawn red box	-	-	2 ¹ / ₂ ", 1 ³ / ₄ "	2 ¹ / ₂ ", 1 ³ / ₄ "	3 ¹ / ₂ ", 2 ³ / ₄ "	21.0	50
72171-1234RD	2 ¹ / ₈ "-deep 4 ¹¹ / ₁₆ " red box	-	-	3 ¹ / ₂ " & 3/4"E	3 ¹ / ₂ " & 3/4"E	3 ¹ / ₂ ", 2 ¹ / ₂ " & 3/4"E	42.0	20
52171-CV-1234RD	2 ¹ / ₈ "-deep 4"-square red box with CV bracket	-	CV	2 ¹ / ₂ ", 1 ¹ / ₂ " & 3/4"E	2 ¹ / ₂ ", 1 ¹ / ₂ " & 3/4"E	3 ¹ / ₂ ", 2 ¹ / ₂ " & 3/4"E	30.3	50
52171-EXTRD	2 ¹ / ₈ "-deep 4"-square red box with ext. ring	-	-	4 ¹ / ₂ ", 2 ¹ / ₂ " & 3/4"E	4 ¹ / ₂ ", 2 ¹ / ₂ " & 3/4"E	3 ¹ / ₂ ", 2 ¹ / ₂ " & 3/4"E	60.6	25
52171-EXTOWRD	2 ¹ / ₈ "-deep 4"-square red box with ext. ring and old work ears	Yes	-	4 ¹ / ₂ ", 2 ¹ / ₂ " & 3/4"E	4 ¹ / ₂ ", 2 ¹ / ₂ " & 3/4"E	3 ¹ / ₂ ", 2 ¹ / ₂ " & 3/4"E	60.6	25
52 C 1RD	Flat 4"-square red cover	-	-	-	-	-	-	100
53171-1234RD	2 ¹ / ₈ "-deep 4"-square red extension ring	-	-	2 ¹ / ₂ ", 1 ¹ / ₂ " & 3/4"E	2 ¹ / ₂ ", 1 ¹ / ₂ " & 3/4"E	-	30.3	25
521911234RD	3 ¹ / ₂ "-deep 4"-square red box	-	-	4 x 1 ¹ / ₂ " & 3/4" Combo	2 x 1 ¹ / ₂ " & 3/4" Combo	4 x 1 ¹ / ₂ " & 3/4" Combo	46	24
521911234CVRD	3 ¹ / ₂ "-deep 4"-square red box w/side mounting bracket	-	CV	4 x 1 ¹ / ₂ " & 3/4" Combo	2 x 1 ¹ / ₂ " & 3/4" Combo	4 x 1 ¹ / ₂ " & 3/4" Combo	46	10

Fire alarm fittings





TK122A-FA TC122A-FA TK121A-FA TC121A-FA

Cat. No.	Description	Std. Ctn.
TC121A-FA	1/2" Red Steel EMT Set Screw Connector	50
TC122A-FA	3/4" Red Steel EMT Set Screw Connector	50
TC123A-FA	1" Red Steel EMT Set Screw Connector	25
TC721A-FA	1/2" Red Insulated Steel EMT Set Screw Connector	50
TC722A-FA	3/4" Red Insulated Steel EMT Set Screw Connector	50
TC723A-FA	1" Red Insulated Steel EMT Set Screw Connector	25
TK121A-FA	1/2" Red Steel EMT Set Screw Coupling	50
TK122A-FA	3/4" Red Steel EMT Set Screw Coupling	50
TK123A-FA	1" Red Steel EMT Set Screw Coupling	25





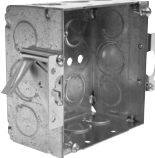

Square boxes and accessories

4" Square old-work box with swing ears and 4" square boxes

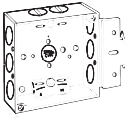
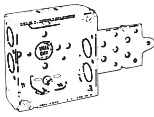
4" Square old-work box with swing ears

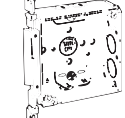
	Cat. No.	Description	Std. Ctn.
	52171-OW	Metallic 4"-Sq. x 2 ¹ / ₈ "D old-work box with factory-mounted swing ears	25
	OW SWING EAR	Swing ears only (for field installation) with self-threading screws	50 (25 pair)

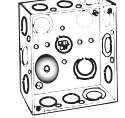
4" Square boxes









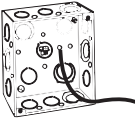
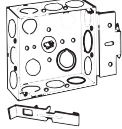
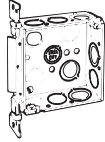
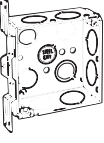

						Knockouts (in.)					
						Each side	Each end	Bottom	Std.		
						Conduit	Conduit	Conduit	Ctn.		
Cat. No.	Depth (in.)	Capacity (cu. in.)	Clamps	Brackets							
With non-metallic sheathed cable clamps											
			52151 N	1 ¹ / ₂	21.0	C-5	-	2- ¹ / ₂ , 1- ¹ / ₂ , ³ / ₄ E	2	1- ¹ / ₂	50
52151 N	52151 MS N*	52151 BN*	52151 MS N*	1 ¹ / ₂	21.0	C-5	MS	2- ¹ / ₂ , 1- ¹ / ₂ , ³ / ₄ E	2	1- ¹ / ₂	25
	52151 BN*		52151 BN*	1 ¹ / ₂	21.0	C-5	B	2- ¹ / ₂ , 1- ¹ / ₂ , ³ / ₄ E	2	1- ¹ / ₂	25
	52151 VN*		52151 VN*	1 ¹ / ₂	21.0	C-5	SV	2- ¹ / ₂ , 1- ¹ / ₂ , ³ / ₄ E	2	1- ¹ / ₂	25
	52151 CVN*		52151 CVN*	1 ¹ / ₂	21.0	C-5	CV	2- ¹ / ₂ , 1- ¹ / ₂ , ³ / ₄ E	2	1- ¹ / ₂	25
	52151 CVNP*		52151 CVNP*	1 ¹ / ₂	21.0	C-5	CV	2- ¹ / ₂ , 1- ¹ / ₂ , ³ / ₄ E	2	1- ¹ / ₂	25
	52171 N		52171 N	2 ¹ / ₈	30.3	C-5	-	2- ¹ / ₂ , 1- ¹ / ₂ , ³ / ₄ E	2	1- ¹ / ₂	25
	52171-VN*		52171-VN*	2 ¹ / ₈	30.3	C-5	SV	2- ¹ / ₂ , 1- ¹ / ₂ , ³ / ₄ E	2	1- ¹ / ₂	25
With conduit KOs											
			52141-1/2	1 ¹ / ₄	18.0	-	-	2- ¹ / ₂	3- ¹ / ₂	5- ¹ / ₂	50
52171 N	2171-VN*	52141-1/2	52151 1/2	1 ¹ / ₂	21.0	-	-	3- ¹ / ₂	3- ¹ / ₂	5- ¹ / ₂	50
			52151-3/4	1 ¹ / ₂	21.0	-	-	2- ³ / ₄	2- ³ / ₄	3- ¹ / ₂ , 2- ³ / ₄	50
			52151 1/2 3/4	1 ¹ / ₂	21.0	-	-	2- ¹ / ₂ , 1- ³ / ₄	2- ¹ / ₂ , 1- ³ / ₄	3- ¹ / ₂ , 2- ³ / ₄	50
			521511234P	1 ¹ / ₂	21.0	-	-	2- ¹ / ₂ , 1- ³ / ₄	2- ¹ / ₂ , 1- ³ / ₄	3- ¹ / ₂ , 2- ³ / ₄	50
			52151-3/4-W	1 ¹ / ₂	21.0	-	-	2- ³ / ₄	2- ³ / ₄	3- ¹ / ₂ , 2- ³ / ₄	50
			52151B1234*	1 ¹ / ₂	21.0	-	B	2- ¹ / ₂ , 1- ¹ / ₂ , ³ / ₄ E	2- ¹ / ₂ , 1- ³ / ₄ , ³ / ₄ E	3- ¹ / ₂ , 2- ¹ / ₂ , ³ / ₄ E	25
			52151-1/2 & 3/4-EW	1 ¹ / ₂	21.0	-	-	2- ¹ / ₂ , 1- ¹ / ₂ , ³ / ₄ E	2- ¹ / ₂ , 1- ¹ / ₂ , ³ / ₄ E	3- ¹ / ₂ , 2- ¹ / ₂ , ³ / ₄ E	50
			521511234P	1 ¹ / ₂	21.0	-	-	2- ¹ / ₂ , 1- ¹ / ₂ , ³ / ₄ E	2- ¹ / ₂ , 1- ¹ / ₂ , ³ / ₄ E	2- ¹ / ₂ , 2- ¹ / ₂ , ³ / ₄ E	50
			521511234EWGB (Ground bump)	1 ¹ / ₂	21.0	-	-	2- ¹ / ₂ , 1- ¹ / ₂ , ³ / ₄ E	2- ¹ / ₂ , 1- ¹ / ₂ , ³ / ₄ E	2- ¹ / ₂ , 2- ¹ / ₂ , ³ / ₄ E	50
			521511234EWGBP (Ground bump with 10 ¹ / ₂ " ground wire)	1 ¹ / ₂	21.0	-	-	2- ¹ / ₂ , 1- ¹ / ₂ , ³ / ₄ E	2- ¹ / ₂ , 1- ¹ / ₂ , ³ / ₄ E	2- ¹ / ₂ , 2- ¹ / ₂ , ³ / ₄ E	50
			52151-1/2 & 3/4 4-EW								

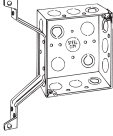
* All bracketed boxes come complete with eccentric knockouts. Per UL514A, suitable for use without a bonding jumper in circuits above or below 250 volts. Pigtail wire is #12 AWG insulated, 10¹/₂" long.

Square boxes and accessories

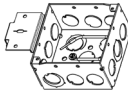
4" Square boxes

4" Square boxes (continued)

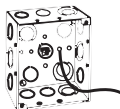
Cat. No.	Depth (in.)	Capacity (cu. in.)	Clamps	Brackets	Knockouts (in.)			Std. Ctn.			
					Each side Conduit	Each end Conduit	Bottom Conduit				
With conduit KOs (continued)											
 521511234EWP	 52151 MS For use on 1 ⁵ / ₈ ", 2 ¹ / ₂ ", 3 ⁵ / ₈ ", 4" studs	 52151-V-1/2 & 3/4 SV bracket mounted flush	521511234EWP*	1 ¹ / ₂	21.0	-	-	2-1/2, 1-1/2, 3/4E	2-1/2, 1-1/2, 3/4E	3-1/2, 2-1/2, 3/4E	50
			52151 MS 1/2 & 3/4*	1 ¹ / ₂	21.0	-	MS	2-1/2, 1-1/2, 3/4E	2-1/2, 1-3/4, 3/4E	3-1/2, 2-1/2, 3/4E	25
			52151-V-1/2 & 3/4*	1 ¹ / ₂	21.0	-	SV	2-1/2, 1-1/2, 3/4E	2-1/2, 1-3/4, 3/4E	3-1/2, 2-1/2, 3/4E	25
			52151 CV 3/4*	1 ¹ / ₂	21.0	-	CV	2-3/4	2-3/4	3-1/2	25
			52151 CV 1/2 3/4*	1 ¹ / ₂	21.0	-	CV	2-1/2, 1-1/2, 3/4E	2-1/2, 1-3/4, 3/4E	3-1/2, 2-1/2, 3/4E	25
			52151DV12*	1 ¹ / ₂	21.0	-	DV	2-1/2, 3/4E	3-1/2, 3/4E	3-1/2, 3/4E	25
 521711234E	 52171 CV 1/2 3/4 CV bracket mounted flush	 52171DV1/2 DV Bracket provides offset	521711234E	2 ¹ / ₈	30.3	-	-	2-1/2, 1-1/2, 3/4E	2-1/2, 1-1/2, 3/4E	3-1/2, 2-1/2, 3/4E	50
 521711234EP	 521711234EP		521711234EP (With 10 ¹ / ₂ " ground wire)	2 ¹ / ₈	30.3	-	-	2-1/2, 1-1/2, 3/4E	2-1/2, 1-1/2, 3/4E	2-1/2, 2-1/2, 3/4E	50
			52171 MS 1/2 3/4*	2 ¹ / ₈	30.3	-	MS	2-1/2, 1-1/2, 3/4E	2-1/2, 1-1/2, 3/4E	3-1/2, 2-1/2, 3/4E	25
 52171MSP	 52171MSP	 52171 3/4	52171MSP* (With 10 ¹ / ₂ " ground wire)	2 ¹ / ₈	30.3	-	MS	2-1/2, 1-1/2, 3/4E	2-1/2, 1-1/2, 3/4E	3-1/2, 2-1/2, 3/4E	25
			52171 3/4	2 ¹ / ₈	30.3	-	-	2-3/4	2-3/4	3-1/2, 2-3/4	50
			52171 1	2 ¹ / ₈	30.3	-	-	2-1	2-1	3-1/2, 2-3/4	50
			52171 V 1/2 & 3/4*	2 ¹ / ₈	30.3	-	SV	2-1/2, 1-1/2, 3/4E	2-1/2, 1-1/2, 3/4E	3-1/2, 2-1/2, 3/4E	25
 52171 1	 52171 V 1/2 & 3/4 SV bracket mounted flush		52171-CV-1/2 & 3/4*	2 ¹ / ₈	30.3	-	CV	2-1/2, 1-1/2, 3/4E	2-1/2, 1-1/2, 3/4E	3-1/2, 2-1/2, 3/4E	25
			52171-EW-SSX*	2 ¹ / ₈	30.3	-	SSX	-	-	-	-
 52171 CV 1/2 & 3/4 CV bracket mounted flush	 521711234EP		521711234EP*	2 ¹ / ₈	30.3	-	V	2-1/2, 1-1/2, 3/4E	2-1/2, 1-1/2, 3/4E	3-1/2, 2-1/2, 3/4E	25
			52171-B-1/2 & 3/4	2 ¹ / ₈	30.3	-	-	2-1/2, 1-1/2, 3/4E	2-1/2, 1-1/2, 3/4E	3-1/2, 2-1/2, 3/4E	25





* All bracketed boxes come complete with eccentric knockouts.
Per UL514A, suitable for use without a bonding jumper in circuits above or below 250 volts.
Pigtail wire is #12 AWG insulated, 10¹/₂" long.

Cat. No.	Description	Ears	Brackets	Each Side KO	Each End KO	Bottom KO	Capacity (cu. in.)	Std. Ctn.
521911234	3 ¹ / ₂ "-deep 4"- square red box	-	-	4 x 1 ¹ / ₂ " & 3/4" Combo	2 x 1 ¹ / ₂ " & 3/4" Combo	4 x 1 ¹ / ₂ " & 3/4" Combo	46	24
521911234CV	3 ¹ / ₂ "-deep 4"-square red box w/side mounting bracket	-	CV	4 x 1 ¹ / ₂ " & 3/4" Combo	2 x 1 ¹ / ₂ " & 3/4" Combo	4 x 1 ¹ / ₂ " & 3/4" Combo	46	10

Square boxes and accessories

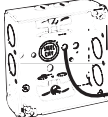
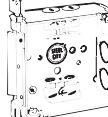
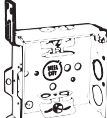
4" Square boxes and Vapor tite boxes

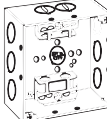
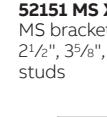
4" Square boxes (continued)

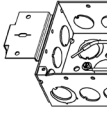
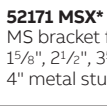
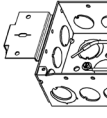
Cat. No.	Depth (in.)	Capacity (cu. in.)	Clamps	Brackets	Knockouts (in.)			Std. Ctn.	
					Each side Conduit	Each end Conduit	Bottom Conduit		
With armored cable/metal-clad clamps									
 52151 X		1 1/4	21.0	C-3	-	2-1/2, 1-1/2, 3/4E	2	1-1/2	50
 52151XP		1 1/4	21.0	C-3	-	2-1/2, 1-1/2, 3/4E	2	1-1/2	50
 52151 VX* SV bracket mounted flush		1 1/4	21.0	C-3	B	2-1/2, 1-1/2, 3/4E	2	1-1/2	25
 52151 BX* B bracket mounted flush		1 1/4	21.0	C-3	SV	2-1/2, 1-1/2, 3/4E	2	1-1/2	25
 52151 VX* CV bracket mounted flush		1 1/4	21.0	C-3	CV	2-1/2, 1-1/2, 3/4E	2	1-1/2	25
 52151 BX* B bracket mounted flush		1 1/4	21.0	C-3	MS	2-1/2, 1-1/2, 3/4E	2	1-1/2	25
 52151 CVX* CV bracket mounted flush		1 1/4	21.0	C-3	MS	2-1/2, 1-1/2, 3/4E	2	1-1/2	25
 52151 MS X* MS bracket for 1 5/8", 2 1/2", 3 5/8", 4" metal studs		1 1/4	21.0	C-3	MS	2-1/2, 1-1/2, 3/4E	2	1-1/2	25
For armored cable and metal-clad clamps									
 52171 X*		2 1/8	30.3	C-3	-	2-1/2, 1-1/2, 3/4E	2	1-1/2	25
 52171 MSX*		2 1/8	30.3	C-3	MS	2-1/2, 1-1/2, 3/4E	2	1-1/2	25
 52171MSXP*		2 1/8	30.3	C-3	MS	2-1/2, 1-1/2, 3/4E	2	1-1/2	25
 52171MSXP* (With 10 1/2" ground wire)		2 1/8	30.3	C-3	MS	2-1/2, 1-1/2, 3/4E	2	1-1/2	25
 52171-CVX*		2 1/8	30.3	C-3	CV-2	1/2-3/4	-	-	25

* All bracketed boxes come complete with eccentric knockouts.
Per UL514A, suitable for use without a bonding jumper in circuits above or below 250 volts. Pigtail wire is #12 AWG insulated, 10 1/2" long.
All 52171 series boxes have a raised ground bump.

Cat. No.	Description	Clamps	Each side Conduit	Each end Conduit	Bottom Conduit	Capacity (cu. in.)	Std. Ctn.
52171-EW-SSX	2 1/8"- deep with conduit KOs	-	1 1/2", 1 1/2" & 3/4"E	2 1/2", 1 1/2" & 3/4"E	2 1/2", 2 1/2" & 3/4"E	30	20
52151-EF-SSX	1 1/2"- deep with conduit KOs	-	1 1/2", 1 1/2" & 3/4"E	2 1/2", 1 1/2" & 3/4"E	2 1/2", 2 1/2" & 3/4"E	21	20
52171-X-SSX	2 1/8"- deep with armored cable clamps	C3	1 1/2", 1 1/2" & 3/4"E	2 Cable	1 1/2"	30	20
52151-X-SSX	1 1/2"- deep with armored cable clamps	C3	1 1/2", 1 1/2" & 3/4"E	2 Cable	1 1/2"	21	20
CXLESSX	3 1/2"- deep with armored cable clamps	C3	2 1/2"	1 1/2" & 2 Cable	1 1/2"	15	20

Features and benefits:

- All K.O.'s pressed flush but still easy to remove
- No holes anywhere
- Top edge of boxes are flush at ears so gasket seals out all air

Vapor tite boxes

Cat. No.	Description	Depth	Std. Ctn.
52151-SVT	4" Sq. box, 1/2" and 3/4" K.O. side and bottom	1 1/2"	50
52C1-VT	4" Sq. blank cover with gasket	Flat	50
52171-SVT	4" Sq. box, 1/2" and 3/4" K.O. side and bottom	2 1/8"	25
72C1-VT	4 11/16" Sq. blank cover with gasket	Flat	50
72171-SVT	4 11/16" Sq. box, 1/2" and 3/4" K.O. side and bottom	2 1/8"	25
54151-VT	4" Sq. Box, 1/2" K.O. side and bottom	1 1/2"	50
54C1-VT	4" Oct. and round box blank cover	Flat	50

Square boxes and accessories

4" Square boxes and thru wall box

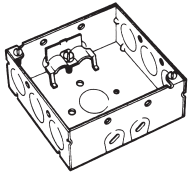

4-SW-LC

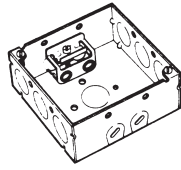

4-SW-MXN

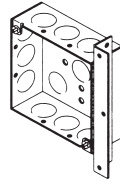

4-SW-AB-1/2

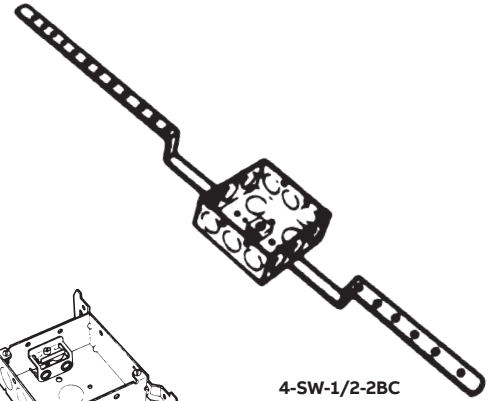

4-SW-1/2-2BC

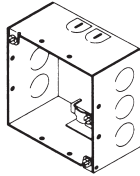

4-SDW-LC

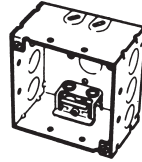

4-SDW-MXN

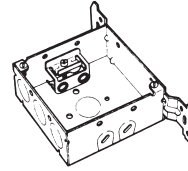

4-SDW-FB-MXN

4" Square boxes

Cat. No.	Depth (in.)	Capacity (cu. in.)	Description	Construction Type	Std. Ctn.
4-SW-LC	1½	21.0	For non-metallic sheathed cable Two loom KO's in each of two opposite sides, three ½" KO's in other two sides and one ½" KO in bottom. Two loom clamps for use on non-metallic sheathed cable with 10/32 deep-slotted screws assembled*	Welded	50
4-SW-MXN	1½	21.0	For metal-clad cable Two loom KO's in each of two opposite sides, three ½" KO's in other two sides and one ½" KO in bottom. Two MXN clamps for MC, AC/BX and non-metallic sheathed cable (NM) included with 10/32 deep-slotted screws. Clamps are UL Listed for use with cable sizes 14/2 through 10/3 with ground*	Welded	50
4-SW-AB-1/2	1½	21.0	Three KO's in each of three sides, angle bracket on other side, and five ½" KO's in bottom. Angle bracket offset 9/16" from top of box*	Welded	50
4-SW-1/2-2BC	1½	21.0	Three ½" KO's in each side and four ½" KO's in bottom. Mounted with clip on 2-BC bar hanger. Hanger is offset correct depth to set box flush with ceiling joist*	Welded	25
4-SDW-LC	2⅞	30.3	For non-metallic sheathed cable Two loom KO's in each of two opposite sides, three ½" KO's in other two sides and one ½" KO in bottom. Two loom clamps for use on non-metallic sheathed cable with 10/32 deep-slotted screws assembled*	Welded	25
4-SDW-MXN	2⅞	30.3	For metal-clad cable Two loom KO's in each of two opposite sides, three ½" KO's in other two sides and one ½" KO in bottom. Two MXN clamps for MC, AC/BX and non-metallic sheathed cable (NM) included with 10/32 deep-slotted screws. Clamps are UL Listed for use with cable sizes 14/2 through 10/3 with ground*	Welded	25
4-SDW-FB-MXN	2⅞	30.3	For metal-clad cable Two loom KO's in each of two opposite sides, three ½" KO's in side opposite flat bracket and one ½" KO in bottom. Two MXN clamps for MC, AC/BX and non-metallic sheathed cable (NM) included with 10/32 deep-slotted screws. Clamps are UL Listed for use with cable sizes 14/2 through 10/3 with ground*	Welded	25

*Uses Steel City® 4" square extension rings and 400 series rings and covers.

4" Square thru wall box





Cat. No.	Depth (in.)	Capacity (cu. in.)	Knockouts (in.)		Std. Ctn.
			Each side Conduit	Each end Conduit	
With conduit KO's					
X1-1/2 & 3/4	1⅞	21.0	2-1/2, -1¾	2-1/2, -1¾	25

Square boxes and accessories

4" Square two-device boxes





4" Square two-device boxes

		Cat. No.	Depth (in.)	Capacity (cu. in.)	Brackets	Knockouts (in.)			Std. Ctn.
						Each side Conduit	Each end Conduit	Bottom Conduit	
		With conduit KOs							
		2G4D 1/2 & 3/4	2 ¹ / ₈	30.3	–	2- ¹ / ₂ , -1 ³ / ₄	2- ¹ / ₂ , -1 ³ / ₄	3- ¹ / ₂ , -2 ³ / ₄	25
		2G4DV 1/2 & 3/4	2 ¹ / ₈	30.3	CV	2- ¹ / ₂ , -1 ³ / ₄	2- ¹ / ₂ , -1 ³ / ₄	3- ¹ / ₂ , -2 ³ / ₄	25

2G4D 1/2 & 3/4

2G4D 1/2 & 3/4
CV bracket recessed 7/8"

4" Square box partitions

				Cat. No.	Description	Std. Ctn.
				For 1 1/2" deep box with square-cut tile wall two-device covers		
				52 PS 1	For 1/2", 3/4" and 1" raised covers	25
				52 PS 2	For 1 1/4", 1 1/2" and 2" raised covers	25
				For 2 1/2" deep box with square-cut tile wall two-device covers		
		52 PD 1	For 1/2", 3/4" and 1" raised covers	25		
		52 PD 2	For 1 1/4", 1 1/2" and 2" raised covers	25		

52 PS 1

52 PS 2

52 PD 1

52 PD 2

4" Square rings and covers

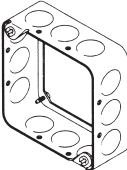
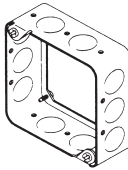
		Cat. No.	Depth (in.)	Capacity (cu. in.)	Description	Construction Type	Std. Ctn.
		4-S-WR-1/2	1 1/2	21.0	Wall Ring Three 1/2" KOs in each side. Four 8/32 screws furnished (two in top and two in bottom)*	Drawn	50
		4-SS-WR-1/2	1 1/2	18.0	Wall Ring Three 1/2" KOs in each of two opposite sides, two 1/2" KOs in other two sides. Four 8/32 screws furnished (two in top and two in bottom)**	Drawn	50



4-S-WR-1/2

4-SS-WR-1/2

*For use with two Steel City® 403-O rings for back to back devices in 2" partitions.

**For use with two Steel City® 403-O rings for back to back devices in 1 3/4" partitions.

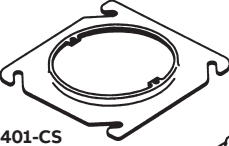
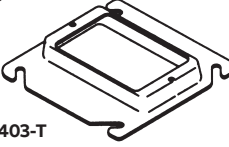
4" Square wall rings

		Cat. No.	Capacity (cu. in.)	Description	Std. Ctn.	
			401-CS	1.0	1/4" raised — 4" square Open plaster ring with ears. Ears tapped 8/32–2 ²³ / ₃₂ " on centers. Special screw lock feature in slots*	25
			403-T	3.5	Tile ring, 1/2" raised — 4" square For single switch or receptacle. Ears tapped 8/32–2 ²³ / ₃₂ " on centers*	50
			405-B	5.0	7/8" raised — 4" square For single switch or receptacle.	25

401-CS

403-T

405-B

*Fits any Steel City® 4" square outlet box or extension ring.

Square boxes and accessories

4" Square industrial device covers

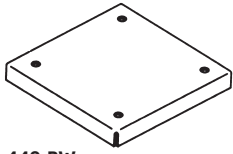

449-BW

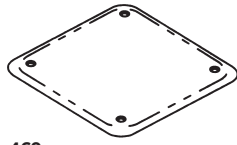

469

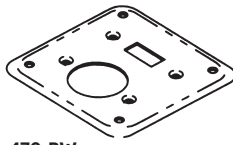

470-BW

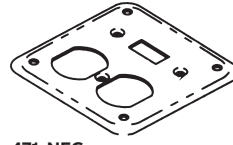

471-NEC

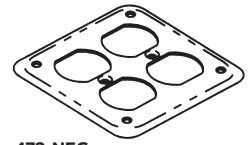

472-NEC

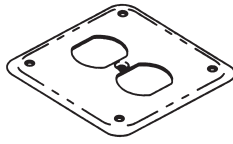

473-NEC

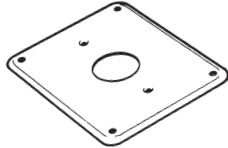

474-BW

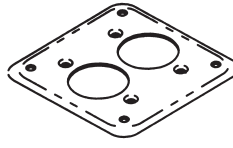

475

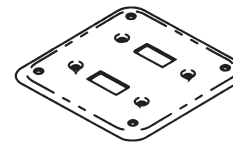

476

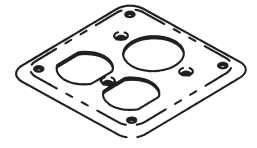

477-NEC

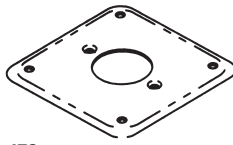

478

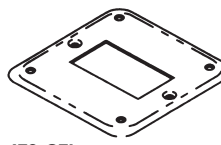

479-GFI

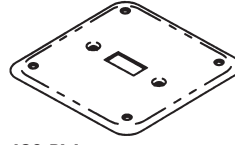

480-BW

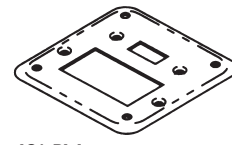

481-BW

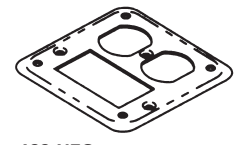

482-NEC

4" Square industrial device covers

Cat. No.	Description	Std. Ctn.
449-BW	Surface blank. Each cover individually packaged with the necessary screws for mounting*	25
469	Surface blank. Each cover individually packaged with the necessary mounting screws*	25
470-BW	For one toggle switch and one single receptacle. Opening 1.4" diameter. Each cover individually packaged with the necessary mounting screws*	25
471-NEC	For one toggle switch and one duplex receptacle. Each cover individually packaged with the necessary mounting screws*	25
472-NEC	For two duplex receptacles. Each cover individually packaged with the necessary mounting screws*	25
473-NEC	For one duplex receptacle in center. Each cover individually packaged with the necessary mounting screws*	25
474-BW	For one single receptacle in center. Opening 1.4" diameter. Each cover individually packaged with the necessary mounting screws*	25
475	For two single receptacles. Openings 1.4" diameter. Each cover individually packaged with the necessary mounting screws*	25
476	For two toggle switches. Each cover individually packaged with the necessary mounting screws*	25
477-NEC	For one duplex and one single receptacle. Opening 1.4" diameter. Each cover individually packaged with the necessary mounting screws*	25
478	For one four-wire twist lock receptacle in center. Opening 1.594" diameter. Each cover individually packaged with the necessary mounting screws*	25
479-GFI	For one GFI receptacle in center. Each cover individually packaged with the necessary mounting screws*	25
480-BW	For one toggle switch in center. Each cover individually packaged with the necessary mounting screws*	25
481-BW	For one GFI receptacle and one toggle switch. Each cover individually packaged with the necessary mounting screws*	25
482-NEC	For one GFI and one duplex receptacle. Each cover individually packaged with the necessary mounting screws*	25

*Fits any Steel City® 4" square outlet box or extension ring.

Square boxes and accessories

4" Square extension rings

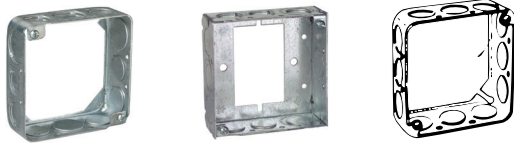

53151 1/2 3/4 531511234UB** 53151 1/2



53151 3/4 531711234* 53171 1

4" Square extension rings

Cat. No.	Knockouts (in.)		Std. Ctn.
	Each side Conduit	Each end Conduit	
1½" deep — with conduit KOs — 21.0 cubic inch capacity			
53151 1/2	3-½	3-½	50
53151 3/4	2-¾	2-¾	25
53151 1/2 3/4	2-½, 1-¾	2-½, 1-¾	50
531511234UB**	2-½, 1-¾, ¾E	2-½	50
2½" deep — with conduit KOs — 30.3 cubic inch capacity			
531711234*	2-½, 1-½, ¾E	2-½, 1-¾	25
53171 1	2-1	2-1	25

* Per UL 514-A, suitable for use without a bonding jumper in circuits above or below 250 volts.
 ** ECC, KOs on sides.

4" Square-cut tile wall covers

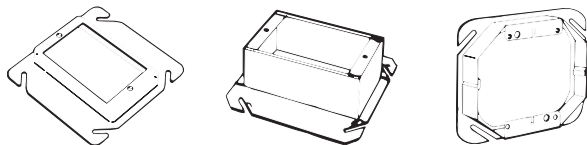

52 C 49 1/2 52C5011/2-25 52 C 52 1/2

4" Square-cut tile wall covers

Cat. No.	Raised (in.)	Description	Capacity (cu. in.)	Std. Ctn.
For single device – steel				
52 C 49 1/2*	½	–	3.5	50
52-C-49-3/4*	¾	–	5.3	50
52-C-49-1*	1	–	7.0	10
52-C-49-1-1/4	1-¼	–	9.3	10
52C5011/2-25	1-½	–	11.0	25
52C512-25	2	–	14.8	25
For two devices – steel				
52 C 52 1/2	½	Square corners facilitate tile	6.0	10
52-C-52-3/4	¾		9.0	10
52-C-52-1	1		12.5	10
52-C-52-1-1/4	1-¾		15.5	10
52 C 53 1 1/2	1-½		19.0	10
52 C 54 2	2-¾		25.5	10

* Drawn style.

4" Square covers

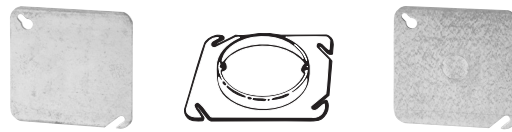

52 C 1 52 C 31 52 C 6

4" Square covers



Cat. No.	Raised (in.)	Description	Capacity (cu. in.)	Std. Ctn.
52 C 1	–	Flat, blank	–	100
52-C-3-25	⅝	Center blanked with tapped ears on 2¾" centers	4.3	25
52-C-3-1/2-25	½		3.5	25
52-C-3-3/4	¾	Center blanked with tapped ears on 22 ²³ / ₃₂ " centers	4.3	25
52 C 31	1		5.8	25
52-C-3-1-1/4	1⅛	7.3	25	
52 C 6	–	Flat, with ½" KO	–	100

4" Square device covers

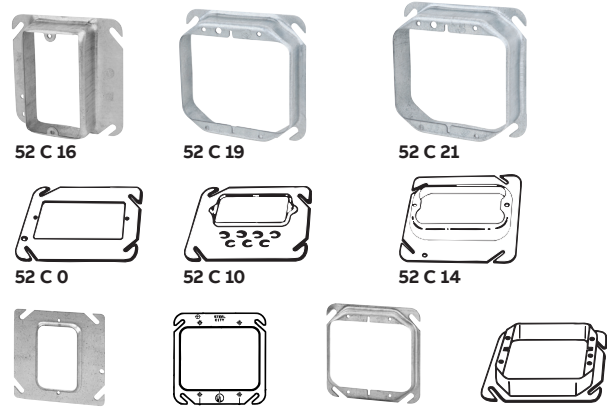

4" Square-cut tile wall covers

Cat. No.	Raised (in.)	Description	Capacity (cu. in.)	Std. Ctn.
For single device – steel				
52 C 0	–	Flat	–	25
52 C 62	¼	Keyed for plaster	1.5	25
52 C 10	¼	Offset, keyed for plaster	1.0	25
52 C 13	½	–	3.0	50
52 C 14	¾	–	5.0	50
52 C 14 5/8	⅝	–	4.0	50
52 C 15	1	–	7.0	25
52 C 16	1¼	–	8.3	25
52-C-36	¼	For drywall construction	1.0	25
For two devices				
52 C 00	–	Flat	–	25
52C20-25	¼	–	2.3	25
52-C-17-25	½	–	6.3	25
52 C 18	¾	–	9.0	25
52-C-18-5/8-25	⅝	For drywall construction	7.3	25
52 C 19	1	–	12.0	25
52 C 21	1¼	–	15.0	25
52 C 37	⅛	–	2.3	25

Square boxes and accessories

Box support covers

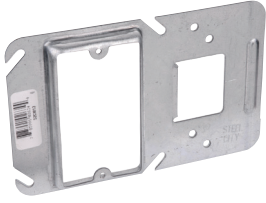

52CM13

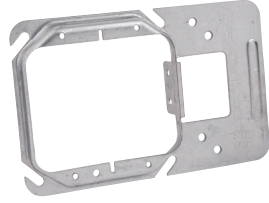

52CMD17

Box support covers

Cat. No.	Raised (in.)	# of Devices	Capacity (cu. in.)	Std. Ctn.
52CM13	1/2	1	3.0	25
52CM14-5/8	5/8	1	4.0	25
52CM14	3/4	1	5.0	25
52CMD17	1/2	2	6.3	25
52CMD18-5/8	5/8	2	7.3	25
52CMD18	3/4	2	9.0	25

Steel City® Box Support Covers combine a box-to-stud mounting bracket with a device cover in one, easy-to-use product. Designed for use with 4" square boxes, Steel City® Box Support Covers can be used with both steel and wood studs.

Features and benefits:

- Combines cover and bracket in one component
- Available in one- and two-device versions
- 1/2", 5/8" and 3/4" raised covers
- Speeds installation time
- Needs no far side support
- Can be used with both steel and wood stud
- Can be used without a box as a low voltage device support
- UL and CSA Listed (UL File #E2969, CSA File #LR5043)

4" Square surface covers



RS 4

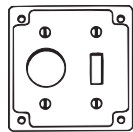

RS 1

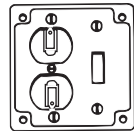

RS 2

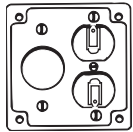

RS 3

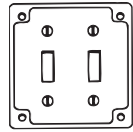

RS 5

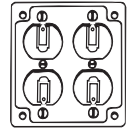

RS 8

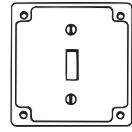

RS 9

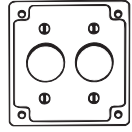

RS 10

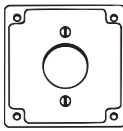

RS 11

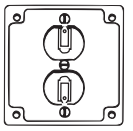

RS 12

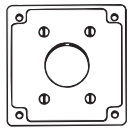

RS 13

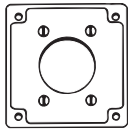

RS 14

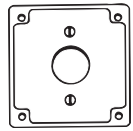

RS 15



RS-16-CC

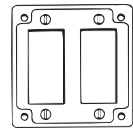

RS-17-CC

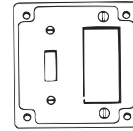

RS-18-CC

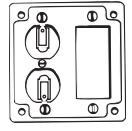

RS-19-CC

4" Square surface covers

Cat. No.	Depth (in.)	Capacity (cu. in.)	Dia. Hole (in.)	Description	Std. Ctn.
RS 1	1/2	5.0	1 ¹³ / ₃₂	For one toggle switch and one single flush receptacle	50
RS 2*	1/2	5.0	—	For one toggle switch and one duplex flush receptacle	50
RS 3*	1/2	5.0	1 ¹³ / ₃₂	For one single and one duplex flush receptacle	50
RS 4	1/2	5.0	1 ¹⁹ / ₃₅	For one 4-wire twist-lock single receptacle	50
RS 5	1/2	5.0	—	For two toggle switches	50
RS 8*	1/2	5.0	—	For two duplex, flush receptacles	50
RS 9	1/2	5.0	—	For one toggle switch	50
RS 10	1/2	5.0	1 ¹³ / ₃₂	For two single, flush receptacles	50
RS 11	1/2	5.0	1 ¹³ / ₃₂	For one single, flush receptacle	50
RS 12*	1/2	5.0	—	For one duplex, flush receptacle	50
RS 13	1/2	5.0	2 ⁵ / ₃₂	For one 30 or 50 amp. dryer or range receptacle	50
RS 14	1/2	5.0	2 ¹⁵ / ₃₂	—	50
RS 15	1/2	5.0	1 ³ / ₄	For #3330-30A 250 V twist-lock	50
RS-16-CC	1/2	5.0	—	For one ground fault receptacle	50
RS-17-CC	1/2	5.0	—	For two ground fault receptacles	50
RS-18-CC	1/2	5.0	—	For one ground fault receptacle and one toggle switch	50
RS-19-CC*	1/2	5.0	—	For one ground fault receptacle and one duplex receptacle	25

Remove portion of G.F.I. receptacle ear to mount receptacle to cover. Screws captivated.

Square boxes and accessories

Adjustable mud rings



UL® Listed adjustable mud ring now available in both single and two-gang. Mud rings feature an inner ring that adjusts from 1/2" to 1 1/2" in. depth to accommodate various drywall thicknesses. Marked with a measured rule and equipped with two adjustment screws, the inner ring can be set to the anticipated depth prior to installation and then easily adjusted after drywall installation to accommodate any variation in depth (1/2" to 1 1/2").

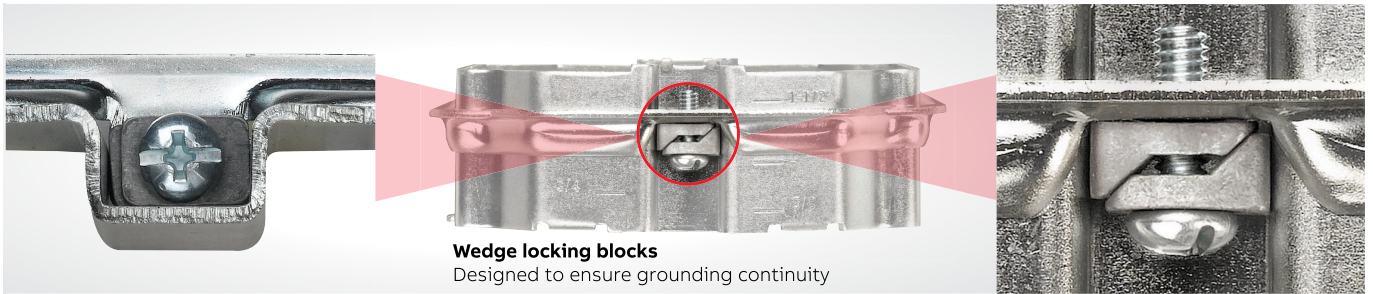

Adjustable mud ring installation/adjustment steps:

- 01 **Loosen...**
The two adjustment screws located on opposing corners of the mud ring.
- 02 **Adjust...**
Inner ring to be flush with wall surface.
- 03 **Re-tighten...**
Adjustment screws.



01

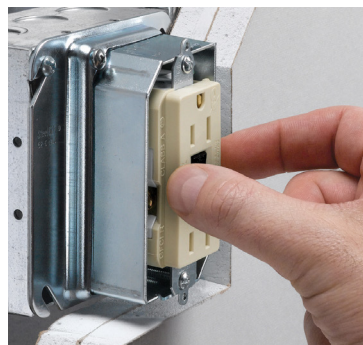

02



03

Adjustable mud rings

Cat. No.	Description	Std. Ctn.
52-C-ADJ	Single-gang adjustable mud ring, 1/2" to 1 1/2"	25
52-C-ADJ2	Two-gang adjustable mud ring, 1/2" to 1 1/2"	20

Square boxes and accessories

Steel City® hands-free swivel hanger



The new Steel City® hands-free swivel hanger allows you to quickly install high- and low-bay lighting fixtures without the need for an extra set of hands. The hanger design enables the fixture to be set in place, giving users access to the conductors while wiring is being completed. The hands-free swivel hanger can support a fixture up to 50 pounds and is ideal for gyms or other commercial sites.

Features and benefits:

- Fits standard 3½" or 4" octagon (SHHFR1234)
- Fits 4" square (SHHF1234) boxes
- A single installer can complete the installation – saving time, labor and cost
- Fixtures can be set in place before wiring is completed
- Design enables users to access the conductors after the fixture has been mounted onto the box
- Accommodates ½" or ¾" threaded fixture pipes
- Permits 20° swing from vertical
- Ideal for gyms or other commercial sites
- Zinc-plated sheet-metal hanger and malleable iron swivel connector
- UL and CSA Listed

Steel City® hands-free swivel hanger

Cat. No.	Description	Std. Ctn.
SHHF 1/2 3/4	Hands-free swivel hanger	25
SHHFR 1/2 3/4	Hands-free swivel hanger (round)	25

Swivel hangers



Swivel hangers for octagonal boxes



Cat. No.	Description	Std. Ctn.
SHR 1/2 & 3/4	Swivel hanger for 4" octagonal boxes	25

UL Listed for 50 lb. fixture support.

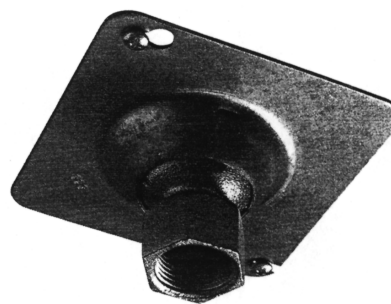

Swivel hangers for square boxes



Cat. No.	Description	Std. Ctn.
SH 1/2 & 3/4	Swivel hanger for 4" square boxes	25

UL Listed for 50 lb. fixture support.

Square boxes and accessories

4¹¹/₁₆" Square boxes



72171 MS 1/2 & 3/4
MS bracket for 1⁵/₈",
2¹/₂", 3³/₈", 4" metal
studs

72151-1/2 & 3/4-E

72171-1/2 & 3/4-E

72171 1

72171 3/4 1

72171 1 1/4

72171CV 1/2 & 3/4

4¹¹/₁₆" Square boxes

Cat. No.	Depth (in.)	Capacity (cu. in.)	Each side Conduit (in.)	Each end Conduit (in.)	Bottom Conduit (in.)	Std. Ctn.
With conduit KOs						
72151-1/2 & 3/4-E*	1 ¹ / ₂	29.5	3-1 ¹ / ₂ , 3/4-3 ³ / ₆₄	2-1 ¹ / ₂ , 3/4-3 ³ / ₆₄	2-1 ¹ / ₂ , 3/4-E, 4-1 ¹ / ₂	20
72171-1/2 & 3/4-E*	2 ¹ / ₈	42.0	3-1 ¹ / ₂ & 3/4-E	3-1 ¹ / ₂ & 3/4-E	2-1 ¹ / ₂ , 3/4-E, 3-1 ¹ / ₂	20
72171 1	2 ¹ / ₈	42.0	*2-1	2-1	3-1 ¹ / ₂ , 2-3/4	20
72171 3/4 1*	2 ¹ / ₈	42.0	1-3/4, 1-1	1-3/4, 1-1	3-1 ¹ / ₂ , 3-3/4, 2-1	20
72171 1 1/4*	2 ¹ / ₈	42.0	2-1 ¹ / ₄	1-1 ¹ / ₄	3-1 ¹ / ₂ , 2-3/4	20
72171CV 1/2 3/4*	2 ¹ / ₈	42.0	2-1 ¹ / ₂ , 1 ³ / ₄	2-1 ¹ / ₂ , 1 ³ / ₄	3-1 ¹ / ₂ , 2-3/4	25
72151 MS 1/2 3/4*	2 ¹ / ₈	42.0	3-1 ¹ / ₂ , 3/4-3 ³ / ₆₄	3-1 ¹ / ₂ , 3/4-3 ³ / ₆₄	2-1 ¹ / ₂ , 3/4-3 ³ / ₆₄ , 3-1 ¹ / ₂	20
72151 MS 1/2 3/4	2 ¹ / ₈	42.0	3-1 ¹ / ₂ , 3/4-3 ³ / ₆₄	2-1 ¹ / ₂ , 3/4-3 ³ / ₆₄	2-1 ¹ / ₂ , 2-3/4-3 ³ / ₆₄ , 4-1 ¹ / ₂	25
72171 MS 1/2 3/4*	2 ¹ / ₈	42.0	3-1 ¹ / ₂ , 3/4-3 ³ / ₆₄	3-1 ¹ / ₂ , 3/4-3 ³ / ₆₄	2-1 ¹ / ₂ , 3/4-3 ³ / ₆₄ , 3-1 ¹ / ₂	25
72151MSX	2 ¹ / ₈	42.0	3-1 ¹ / ₂ , 3/4-3 ³ / ₆₄	2-1 ¹ / ₂ , 3/4-3 ³ / ₆₄	2-1 ¹ / ₂ , 2-3/4-3 ³ / ₆₄ , 4-1 ¹ / ₂	25
72151MSXP	2 ¹ / ₈	42.0	3-1 ¹ / ₂ , 3/4-3 ³ / ₆₄	2-1 ¹ / ₂ , 3/4-3 ³ / ₆₄	2-1 ¹ / ₂ , 2-3/4-3 ³ / ₆₄ , 4-1 ¹ / ₂	25
72151MSP	2 ¹ / ₈	42.0	3-1 ¹ / ₂ , 3/4-3 ³ / ₆₄	3-1 ¹ / ₂ , 3/4-3 ³ / ₆₄	3-1 ¹ / ₂ , 2-1 ¹ / ₂ , 3/4-3 ³ / ₆₄	25
72171MSX	2 ¹ / ₈	42.0	3-1 ¹ / ₂ , 3/4-3 ³ / ₆₄	3-1 ¹ / ₂ , 3/4-3 ³ / ₆₄	3-1 ¹ / ₂ , 2-1 ¹ / ₂ , 3/4-3 ³ / ₆₄	25
72171MSXP	2 ¹ / ₈	42.0	3-1 ¹ / ₂ , 3/4-3 ³ / ₆₄	3-1 ¹ / ₂ , 3/4-3 ³ / ₆₄	3-1 ¹ / ₂ , 2-1 ¹ / ₂ , 3/4-3 ³ / ₆₄	25

Per UL 514-A, suitable for use without a bonding jumper in circuits above or below 250 volts.

4¹¹/₁₆" Square boxes

Cat. No.	Depth (in.)	Capacity (cu. in.)	Description	Construction Type	Std. Ctn.
5-SDW-FB-1	2 ¹ / ₈	42.0	Two 1" KOs in each of three sides, flat bracket on other side and three 1 ¹ / ₂ " KOs in a line in bottom with two 3/4" KOs at opposite ends in bottom.	Welded	25

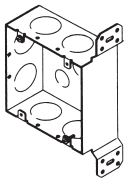

4¹¹/₁₆" Square box extension rings

Cat. No.	Depth (in.)	Capacity (cu. in.)	Knockouts (in.)		Std. Ctn.
			Each side Conduit	Each end Conduit	
With conduit KOs					
73151 1/2 3/4*	1 ¹ / ₂	29.5	2-1 ¹ / ₂ , 1 ¹ / ₄	2-1 ¹ / ₂ , 1 ¹ / ₄	20
73171 1/2 3/4*	2 ¹ / ₈	42.0	2-1 ¹ / ₂ , 1 ¹ / ₄	2-1 ¹ / ₂ , 1 ¹ / ₄	20
73171 1	2 ¹ / ₈	42.0	2-1	2-1	20

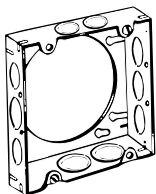

73151 1/2 & 3/4

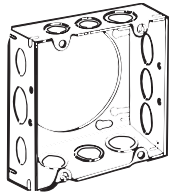

73171 1/2 & 3/4

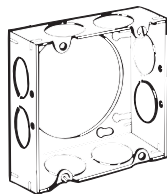

73171 1

Square boxes and accessories

4^{11/16}" Square covers, rings, tile rings and box partitions

4^{11/16}" Square covers

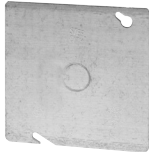
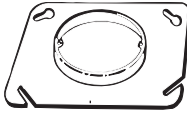
	Cat. No.	Capacity (cu. in.)	Raised (in.)	Description	Std. Ctn.
	72 C 1	-	-	Flat blank	50
	72 C 6	-	-	Flat with 1/2" KO	25
	72 C 3	3.5	5/8		10
	72-C-3-1/2	3.0	1/2	Center blanked with	25
	72-C-3-3/4	4.3	3/4	tapped ears on	10
	72-C-3-1	5.8	1	2 ^{23/32} " centers	25

4" Square rings and covers

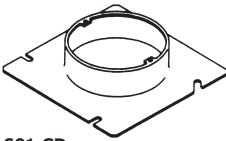
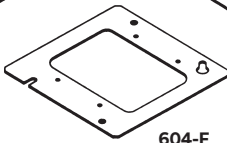
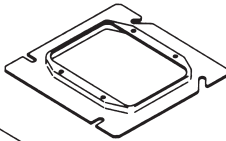
	Cat. No.	Capacity (cu. in.)	Description	Std. Ctn.
	601-CD	8.8	1 1/4" raised - 4 ^{11/16} " square Open plaster ring with ears. Ears tapped 8/32-2 ^{23/32} " on centers. Special screw lock feature in slots*	25
	604-F	-	Flat - 4 ^{11/16} " square For two switches or receptacles*	25
	604-B	2.8	1/4" raised - 4 ^{11/16} " square For two switches or receptacles*	25

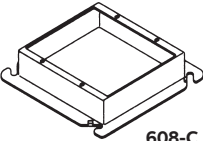

*Fits any Steel City® 4^{11/16}" square outlet box or extension ring.

4^{11/16}" Square tile rings

	Cat. No.	Capacity (cu. in.)	Description	Std. Ctn.
	608-C	12.5	1" raised - 4 ^{11/16} " square For two switches or receptacles*	10

*Fits any Steel City® 4^{11/16}" square outlet box or extension ring.

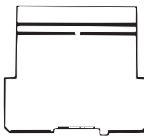
4^{11/16}" Square box partitions

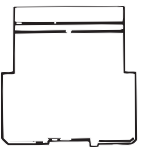
	Cat. No.	Description	Std. Ctn.
	For 1 1/4" deep box with square-cut tile wall - two-device covers		
	72 PS 1	For 1/2", 3/4" and 1" raised covers	25
	72 PS 2	For 1 1/4", 1 1/2" and 2" raised covers	25
	For 2 1/8" deep box with square-cut tile wall - two-device covers		
	72 PD 1	For 1/2", 3/4" and 1" raised covers	25
	72 PD 2	For 1 1/4", 1 1/2" and 2" raised covers	25

Square boxes and accessories

4¹¹/₁₆" Square surface and device covers

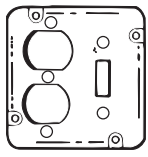

RSL 2

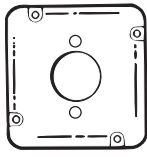

RSL 4

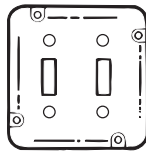

RSL 5

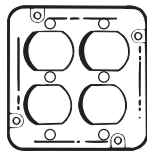

RSL 8

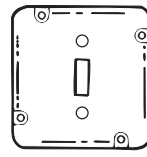

RSL 9

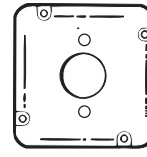

RSL 11

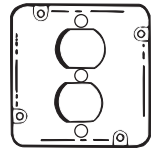

RSL 12

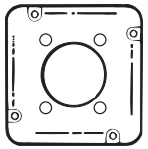

RSL 13

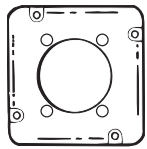

RSL 14

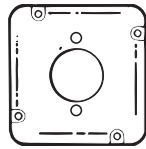

RSL 15

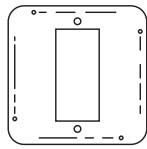

RSL 16

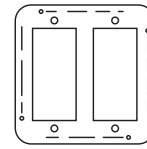

RSL 17

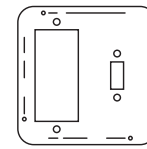

RSL 18

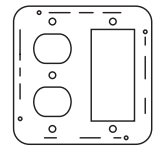

RSL 19

4¹¹/₁₆" Square surface covers

Cat. No.	Depth (in.)	Capacity (cu. in.)	Dia. Hole (in.)	Description	Std. Ctn.
RSL 2	1/2	7.5	–	For one toggle switch and one duplex flush receptacle	10
RSL 4	1/2	7.5	1 ¹¹ / ₃₂	For one 4-wire twist-lock single receptacle	10
RSL 5	1/2	7.5	–	For two toggle switches	10
RSL 8	1/2	7.5	–	For two duplex, flush receptacles	10
RSL 9	1/2	7.5	1 ⁵ / ₃₂	For one toggle switch	10
RSL 11	1/2	7.5	1 ⁵⁵ / ₆₄	For one single, flush receptacle	10
RSL 12	1/2	7.5	–	For one duplex, flush receptacle	10
RSL 13	1/2	7.5	2 ⁵ / ₃₂	For one 30A to 50A dryer or range receptacle	10
RSL 14	1/2	7.5	2 ⁵ / ₃₂	–	10
RSL 15	1/2	7.5	1 ³ / ₄	For #3330–30A 250 V twist-lock receptacle	10
RSL 16	1/2	7.5	–	For one ground fault receptacle	10
RSL 17	1/2	7.5	–	For two ground fault receptacles	10
RSL 18	1/2	7.5	–	For one ground fault receptacle and one toggle switch	10
RSL 19	1/2	7.5	–	For one ground fault receptacle and one duplex receptacle	10

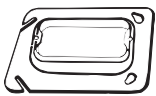

72 C 13



72 C 15

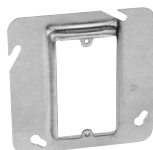

72 C 14



72 C 17

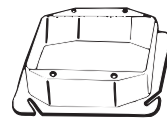

72 C 21

4¹¹/₁₆" Square device covers

Cat. No.	Depth (in.)	Capacity (cu. in.)	Std. Ctn.
For single device			
72 C 62	1/4	1.0	25
72 C 13	1/2	3.0	25
72 C 14	3/4	5.0	25
72 C 14 5/8	5/8	4.0	25
72 C 15	1	7.0	10
72 C 16	1 ¹ / ₄	8.3	10
For two devices			
72 C 17	1/2	6.3	25
72 C 18	3/4	9.0	25
72 C 18 5/8	5/8	7.5	25
72 C 19	1	12.0	25
72 C 21	1 ¹ / ₄	15.0	25

Square boxes and accessories

4¹¹/₁₆" Square-cut tile wall covers and industrial device covers

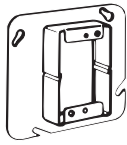

72 C 49 3/4



72 C 50 1 1/2

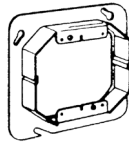

72 C 52 3/4

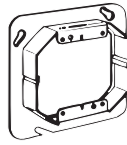

72 C 53 1 1/2

4¹¹/₁₆" Square-cut tile wall covers

Cat. No.	Depth (in.)	Capacity (cu. in.)	Std. Ctn.
For single device – steel			
72-C-49-1/2	1/2	3.5	10
72 C 49 3/4	3/4	5.3	10
72-C-49-1	1	7.0	10
72-C-49-1-1/4	1 1/4	7.0	10
72 C 50 1 1/2	1 1/2	9.0	10
72 C 51 2	2	14.5	20
For two devices – steel			
72-C-52-1/2	1/2	6.0	10
72 C 52 3/4	3/4	9.0	10
72-C-52-1	1	12.5	25
72-C-52-1-1/4	1 1/4	15.5	25
72 C 53 1 1/2	1 1/2	19.0	10
72 C 54 2	2	25.5	10

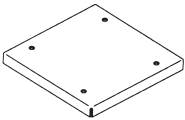

649

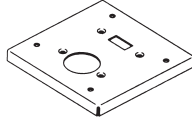

650-BW

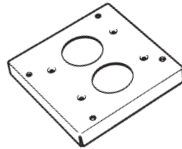

655

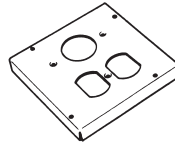

657-NEC

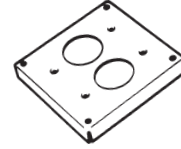

663-BW

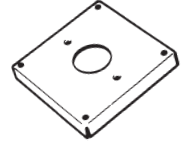

665-BW

4¹¹/₁₆" Square industrial device covers

Cat. No.	Capacity (cu. in.)	Description	Std. Ctn.
649	7.5	1/2" raised – 4 ¹¹ / ₁₆ " square Surface blank. Each cover individually packaged with the necessary screws for mounting*	10
650-BW	7.5	1/2" raised – 4 ¹¹ / ₁₆ " square For one toggle switch and one single receptacle. Opening 1.4" diameter. Each cover individually packaged with the necessary mounting screws*	10
655	7.5	1/2" raised – 4 ¹¹ / ₁₆ " square For two single receptacles. Opening 1.4" diameter. Each cover individually packaged with the necessary screws for mounting*	10
657-NEC	7.5	1/2" raised – 4 ¹¹ / ₁₆ " square For one duplex and one single receptacle. Opening 1.4" diameter. Each cover individually packaged with the necessary screws for mounting*	10
663-BW	7.5	1/2" raised – 4 ¹¹ / ₁₆ " square For two three-wire twist lock receptacles. 1 ¹¹ / ₁₆ " spacing between 1.4" diameter openings. Each cover individually packaged with the necessary screws for mounting*	10
665-BW	7.5	1/2" raised – 4 ¹¹ / ₁₆ " square Opening to accommodate Hubbell 3330 receptacle in center. Opening 1.75" diameter. Each cover individually packaged with the necessary screws for mounting*	10

*Fits any Steel City® 4¹¹/₁₆" square outlet box or extension ring.

Utility boxes and accessories

4" x 2¹/₈" Utility boxes and box covers



58351 1/2*

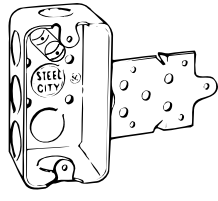

58351 B 1/4
B bracket recessed 1/4"



58361 1/2*

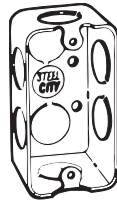

58361 3/4

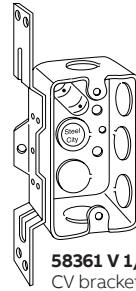

58361 V 1/2*
CV bracket recessed 1/2"

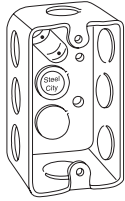

58371 1/2*

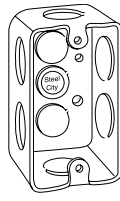

58371 3/4

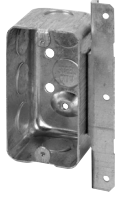

58371 T 1/2*
T bracket recessed 5/8"



58371V1/2-25*
CV bracket recessed 1/2"

4" x 2¹/₈" Utility boxes

Cat. No.	Depth (in.)	Capacity (cu. in.)	Brackets	Each side Conduit (in.)	Each end Conduit (in.)	Knockouts (in.)		Std. Ctn.
						Bottom Conduit (in.)		
With conduit KOs								
58351 1/2*	1 1/2	10.3	-	3-1/2	1-1/2	2-1/2		50
58351 B 1/4	1 1/2	10.3	B	3-1/2	1-1/2	2-1/2		25
58361 1/2*	1 7/8	13.0	-	3-1/2	1-1/2	2-1/2		50
58361 3/4	1 7/8	13.0	-	2-3/4	1-3/4	2-3/4		50
58361 V 1/2*	1 7/8	13.0	CV	3-1/2	1-1/2	2-1/2		50
58371 1/2*	2 1/8	14.5	-	3-1/2	1-1/2	2-1/2		50
58371 3/4	2 1/8	14.5	-	2-3/4	1-3/4	2-3/4		50
58371 T 1/2*	2 1/8	14.5	T	3-1/2	1-1/2	2-1/2		25
58371V1/2-25*	2 1/8	14.5	CV	3-1/2	1-1/2	2-1/2		25

* Factory-provided raised ground-screw location.

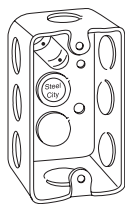

68361 1/2

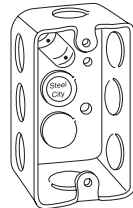

68371 1/2

4 1/8" x 2 1/2" Utility boxes

Cat. No.	Depth (in.)	Capacity (cu. in.)	Knockouts (in.)			Std. Ctn.
			Ea. side Conduit	Ea. end Conduit	Bottom Conduit	
With conduit KOs						
68361 1/2*	1 15/16	17.0	3-1/2	1-1/2	2-1/2	25
68371 1/2*	2 3/16	18.8	3-1/2	1-1/2	2-1/2	50

4 1/8" x 2 1/8" Utility box covers

Cat. No.	Dia. Hole (in.)	Description	Std. Ctn.
Raised 1/4"			
58 C 1	-	Blank	100
58 C 4	1 19/32	For 4-wire twist-lock single flush receptacle	25
58 C 5	1 13/32	For single receptacle	25
58 C 6	-	With 1/2" KO	25
58 C 7	-	For duplex flush receptacle	100
58 C 11	-	With 15/32" bushed hole	25
58 C 16	-	For single GFCI receptacle	25
58 C 30	-	For one toggle switch	100



58 C 1



58 C 4

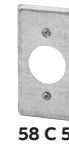

58 C 5



58 C 6



58 C 7



58 C 11

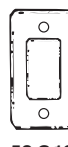

58 C 16





58 C 30

Utility/Handy boxes and accessories

4¹/₈" x 2¹/₂" Utility box covers raised, extension rings and handy boxes

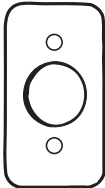
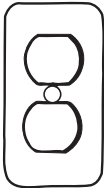
4¹/₈" x 2¹/₂" Utility box covers raised

					Cat. No.	Dia. Hole (in.)	Description	Std. Ctn.
					68 C 1	–	Blank	25
					68 C 5	1 ¹³ / ₃₂	For single receptacle	25
					68 C 6	–	With 1/2" KO	25
					68 C 7	–	For duplex flush receptacle	25
					68 C 30	–	For one toggle switch	25

Includes captivated Phillips head screws.

4" x 2¹/₈" Utility box extension rings

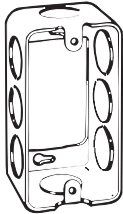
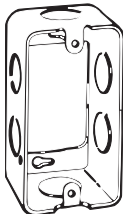
					Knockouts (in.)		Std. Ctn.
		Cat. No.	Depth (in.)	Capacity (cu. in.)	Each side Conduit	Each end Conduit	
		With conduit KOs					
		59361 1/2	1 ⁷ / ₈	13.0	3- ¹ / ₂	1- ¹ / ₂	50
		59361 3/4	1 ⁷ / ₈	13.0	2- ³ / ₄	1- ³ / ₄	25

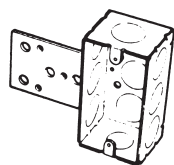

102-W-LB-1/4

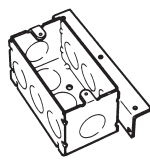

103-W-AB

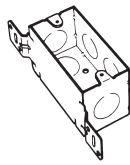

104-W-FB-3/4



106-3/4

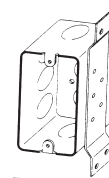

106-FB-1/2

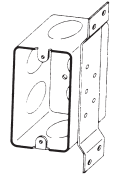

106-FB-3/4

Handy boxes

Cat. No.	Depth (in.)	Capacity (cu. in.)	Description	Construction Type	Std. Ctn.
102-W-LB-1/4	1 ¹ / ₂	10.3	1¹/₂" deep x 4" long x 2¹/₈" wide Three 1/2" KOs in one side, lateral bracket on other side, one 1/2" KO in each end and three 1/2" KOs in bottom. Furnished with four mounting holes in bottom. Bracket offset 1/4" from face*	Welded	50
103-W-AB	1 ⁷ / ₈	13.0	1⁷/₈" deep x 4" long x 2¹/₈" wide Three 1/2" KOs in one side, angle bracket on other side, one 1/2" KO in each end and three 1/2" KOs in bottom. Bracket offset 9/16" from face*	Welded	50
104-W-FB-3/4	2 ¹ / ₈	14.5	2¹/₈" deep x 4" long x 2¹/₈" wide Two 3/4" KOs in one side, flat bracket on other side, one 3/4" KO in each end and two 3/4" KOs in bottom.	Welded	50
106-3/4	2 ³ / ₁₆	18.0	2³/₁₆" deep x 4¹/₈" long x 2³/₈" wide Two 3/4" KOs in each side, one 3/4" KO in each end and three 1/2" KOs in bottom. Two mounting holes in bottom.	Drawn	50
106-FB-1/2	2 ³ / ₁₆	18.0	2³/₁₆" deep x 4¹/₈" long x 2³/₈" wide Three 1/2" KOs in one side, flat bracket on other side, one 1/2" KO in each end and three 1/2" KOs in bottom. Flat bracket offset 9/16" from face.	Drawn	50
106-FB-3/4	2 ³ / ₁₆	18.0	2³/₁₆" deep x 4¹/₈" long x 2³/₈" wide Two 3/4" KOs in each side, flat bracket on other side, one 3/4" KO in each end and three 1/2" KOs in bottom. Flat bracket offset 9/16" from face.	Drawn	50

Uses Steel City® 100 series covers.

Handy/Gang boxes and accessories

Multi-gang handy boxes and drawn-style gang boxes

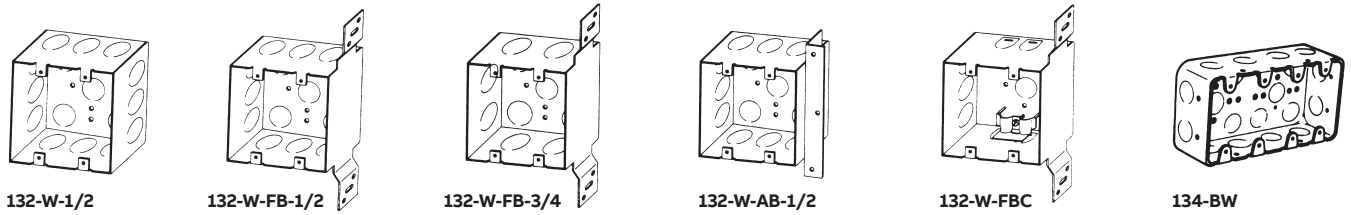

Multi-gang handy boxes

Cat. No.	Depth (in.)	Capacity (cu. in.)	Description	Std. Ctn.
132-W-1/2	2 ¹ / ₈	30.3	A two-gang box, 2¹/₈" deep – 4" square Three 1/2" KOs in each of four sides and three 1/2" KOs in a line in bottom with two 3/4" KOs at opposite ends in bottom*	25
132-W-FB-1/2	2 ¹ / ₈	30.3	A two-gang box, 2¹/₈" deep – 4" square Three 1/2" KOs in each of three sides, flat bracket on fourth side and five 1/2" KOs in bottom. Flat bracket offset 9/16" from face*	25
132-W-FB-3/4	2 ¹ / ₈	30.3	A two-gang box, 2¹/₈" deep – 4" square Two 3/4" KOs in each of three sides, flat bracket on fourth side and three 1/2" KOs in a line with two 3/4" KOs at opposite ends in bottom. Flat bracket offset 9/16" from face*	25
132-W-AB-1/2	2 ¹ / ₈	30.3	A two-gang box, 2¹/₈" deep – 4" square Three 1/2" KOs in each of three sides, angle bracket on fourth side and five 1/2" KOs in bottom. Bracket offset 9/16" from face*	25
132-W-FBC	2 ¹ / ₈	30.3	For non-metallic cable – a two-gang box, 2¹/₈" deep – 4" square Two loom KOs in each of two opposite sides, two 1/2" KOs in side opposite flat bracket and one 1/2" KO in bottom. Two loom clamps for use on non-metallic sheathed cable with 10/32 deep-slotted screws assembled. Flat bracket offset 9/16" from face*	25
134-BW	2 ¹ / ₈	58.0	A four-gang box Four 1/2" KOs in each side, two 1/2" KOs in each end and ten 1/2" KOs in bottom. Uses Steel City SB-4 cover.	20

*Uses Steel City® SB-2 covers.

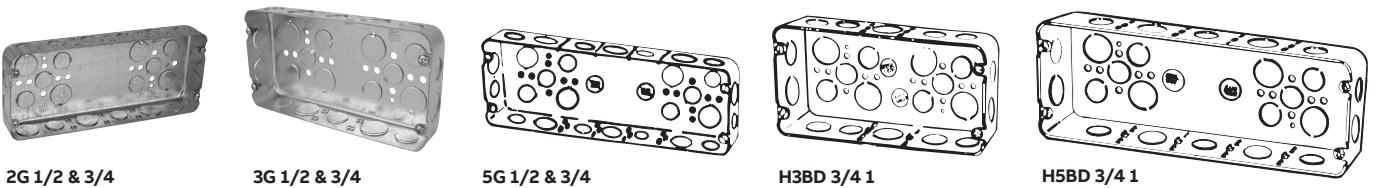

Drawn-style gang boxes

Cat. No.	Depth (in.)	Capacity (cu. in.)	Height (in.)	Length (in.)	Each side Conduit (in.)	Each end Conduit (in.)	Knockouts (in.)		Std. Ctn.
							Bottom Conduit (in.)		
With conduit KOs									
2G 1/2 3/4	1 ⁵ / ₈	45.0	4 ¹ / ₂	6 ¹³ / ₁₆	2- ¹ / ₂ , 2- ³ / ₄	1- ¹ / ₂ , 1- ³ / ₄	3- ¹ / ₂ , 2- ³ / ₄		5
3G 1/2 3/4	1 ⁵ / ₈	58.0	4 ¹ / ₂	8 ⁵ / ₈	3- ¹ / ₂ , 2- ³ / ₄	1- ¹ / ₂ , 1- ³ / ₄	6- ¹ / ₂ , 4- ³ / ₄		5
4G 1/2 3/4	1 ⁵ / ₈	70.0	4 ¹ / ₂	10 ⁷ / ₁₆	3- ¹ / ₂ , 3- ³ / ₄	1- ¹ / ₂ , 1- ³ / ₄	6- ¹ / ₂ , 4- ³ / ₄		5
5G 1/2 3/4	1 ⁵ / ₈	85.0	4 ¹ / ₂	12 ¹ / ₄	4- ¹ / ₂ , 3- ³ / ₄	1- ¹ / ₂ , 1- ³ / ₄	6- ¹ / ₂ , 4- ³ / ₄		1
6G 1/2 3/4	1 ⁵ / ₈	95.0	4 ¹ / ₂	14 ¹ / ₁₆	4- ¹ / ₂ , 4- ³ / ₄	1- ¹ / ₂ , 1- ³ / ₄	6- ¹ / ₂ , 4- ³ / ₄		1
H2BD 3/4 1	2 ¹ / ₂	71.0	4 ¹ / ₂	6 ¹³ / ₁₆	2- ³ / ₄ , 1-1	1- ³ / ₄ , 1-1	3- ¹ / ₂ , 2- ³ / ₄		10
H3BD 3/4 1	2 ¹ / ₂	90.0	4 ¹ / ₂	8 ⁵ / ₈	4- ³ / ₄ , 1-1	1- ³ / ₄ , 1-1	6- ¹ / ₂ , 4- ³ / ₄		10
H4BD 3/4 1	2 ¹ / ₂	110.0	4 ¹ / ₂	10 ⁷ / ₁₆	2- ³ / ₄ , 2-1	1- ³ / ₄ , 1-1	6- ¹ / ₂ , 4- ³ / ₄		5
H5BD 3/4 1	2 ¹ / ₂	132.0	4 ¹ / ₂	12 ¹ / ₄	3- ³ / ₄ , 2-1	1- ³ / ₄ , 1-1	6- ¹ / ₂ , 4- ³ / ₄		5
H6BD 3/4 1	2 ¹ / ₂	150.0	4 ¹ / ₂	14 ¹ / ₁₆	3- ³ / ₄ , 3-1	1- ³ / ₄ , 1-1	6- ¹ / ₂ , 4- ³ / ₄		5

Gang boxes and accessories

Multi-gang boxes and gang box partitions

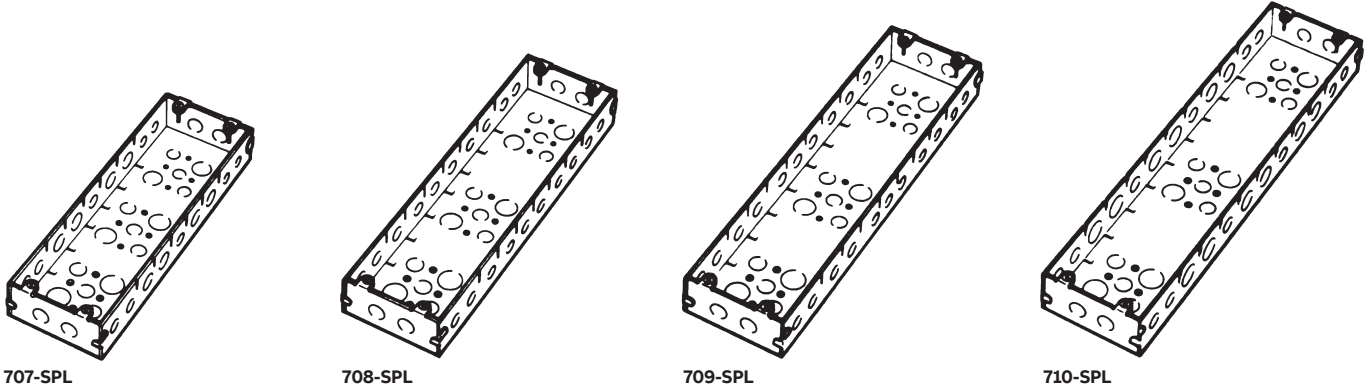

Multi-gang boxes

Cat. No.	Capacity (cu. in.)	Description	Std. Ctn.
707-SPL	126.5	Seven-gang box, 1¹³/₁₆" deep x 4⁹/₁₆" long x 15¹⁵/₁₆" wide Five 1/2" KOs and four 3/4" KOs in each side, two 1/2" KOs in each end and nine 1/2" KOs with six 3/4" KOs in bottom. Furnished with four 8/32 screws. For use with either Steel City® 807 and SB-7, 808 and SB-8, or just GB-7 rings and covers	1
708-SPL	141.3	Eight-gang box, 1¹³/₁₆" deep x 4⁹/₁₆" long x 17³/₄" wide Six 1/2" KOs and four 3/4" KOs in each side, two 1/2" KOs in each end and nine 1/2" KOs with six 3/4" KOs in bottom. Furnished with four 8/32 screws. For use with either Steel City® 808 and SB-8, 809 and SB-9, or just GB-8 rings and covers	1
709-SPL	155.8	Nine-gang box, 1¹³/₁₆" deep x 4⁹/₁₆" long x 19⁹/₁₆" wide Six 1/2" and five 3/4" KOs in each side and two 1/2" KOs in each end and nine 1/2" KOs with six 3/4" KOs in bottom. Furnished with four 8/32 screws. For use with either Steel City® 809 and SB-9, 810 and SB-10, or just GB-9 rings and covers	1
710-SPL	170.5	Ten-gang box, 1¹³/₁₆" deep x 4⁹/₁₆" long x 21³/₈" wide Six 1/2" KOs and six 3/4" KOs in each side, two 1/2" KOs in each end and nine 1/2" KOs with six 3/4" KOs in bottom. Furnished with four 8/32 screws. For use with either Steel City® 810 and SB-10, or just GB-10 rings and covers	1

Gang box partitions

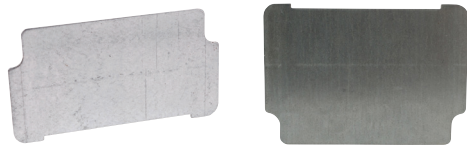

SGP

DGP

Cat. No.	Description	Std. Ctn.
SGP	Hi/low-voltage partition for 1 ⁵ / ₈ "-deep box	25
DGP	Hi/low-voltage partition for 2 ¹ / ₂ "-deep box	50

Gang boxes and accessories

2-, 3- and 4-gang drawn-style device boxes and gang box covers

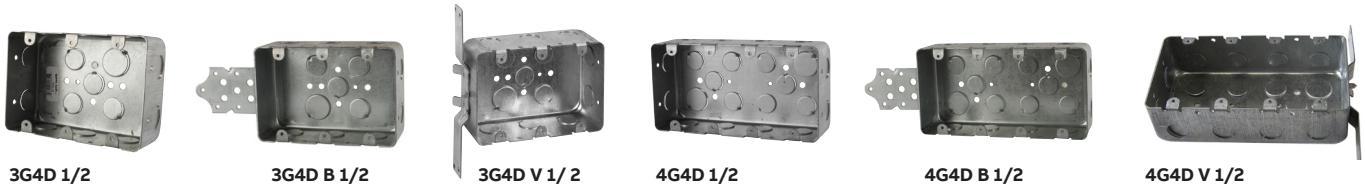

2-, 3- and 4-Gang drawn-style

Cat. No.	Gang	Depth (in.)	Capacity (cu. in.)	Brackets	Each side Conduit (in.)	Each end Conduit (in.)	Std. Ctn.
2G4DV 1/2 3/4	2	2-1/8	30.3	CV	2-1/2, 1-3/4	2-1/2, 1-3/4	25
3G4D 1/2	3	2-1/8	44.3	-	3-1/2	2-1/2	20
3G4D B 1/2	3	2-1/8	44.3	B	3-1/2	2-1/2	20
3G4D V 1/2	3	2-1/8	44.3	CV	3-1/2	2-1/2	20
4G4D 1/2	4	2-1/8	58.0	-	4-1/2	2-1/2	20
4G4D B 1/2	4	2-1/8	58.0	B	4-1/2	2-1/2	20
4G4D V 1/2	4	2-1/8	58.0	CV	4-1/2	2-1/2	20

When covers are required to accommodate various combinations of devices, use the following catalog numbers plus the suffix "SPECIAL," and then indicate the combinations desired. When necessary, also indicate the sequence of devices.

- As illustrated (below), this is a 4-GCS Special for two toggle switches on left side and two duplex receptacles on right side

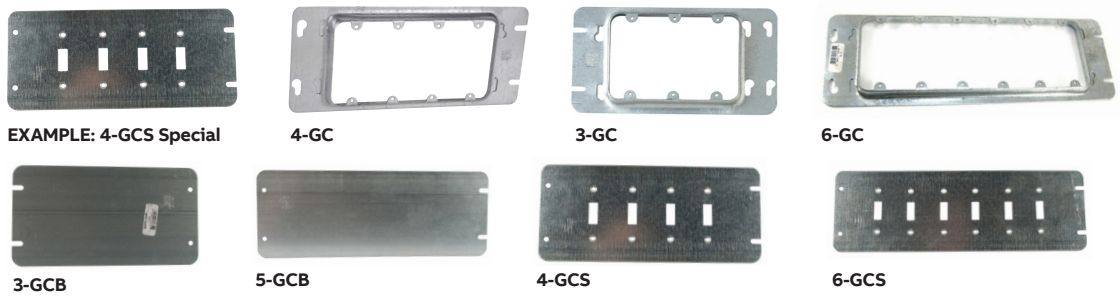

Gang box covers

Cat. No.	Length (in.)	Capacity (cu. in.)	Description	Std. Ctn.
4¹¹/₁₆" Wide – raised ¹³/₁₆" for plaster				
2-GC	7	8.5	Holes between gangs are spaced on ¹³ / ₁₆ " centers; tapped holes in ears; spaced on 3 ⁹ / ₃₂ " centers to accommodate all standard receptacles and switches; furnished with extra plugged screw holes; if these screw holes are used, the cover will fit the next smaller size box.	5
3-GC	8 ¹³ / ₁₆	13.5		5
4-GC	10 ⁵ / ₈	18.3		5
5 GC	12 ⁷ / ₁₆	23.0		5
6 GC	14 ¹ / ₄	28.3		5
4¹¹/₁₆" Wide – flat, blank				
2-GCB	7	-	-	25
3-GCB	8 ¹³ / ₁₆	-	-	25
4-GCB	10 ⁵ / ₈	-	-	25
5 GCB	12 ⁷ / ₁₆	-	-	25
6 GCB	14 ¹ / ₄	-	-	25
4¹¹/₁₆" Wide – flat for toggle switches				
2-GCS	7	-	For 2 toggle switches	25
3-GCS	8 ¹³ / ₁₆	-	For 3 toggle switches	25
4-GCS	10 ⁵ / ₈	-	For 4 toggle switches	25
5 GCS	12 ⁷ / ₁₆	-	For 5 toggle switches	25
6 GCS	14 ¹ / ₄	-	For 6 toggle switches	25

4¹¹/₁₆" wide – special covers – flat to accommodate combinations of devices.

Gang boxes and accessories

Multi-gang rings

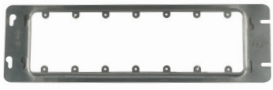

807

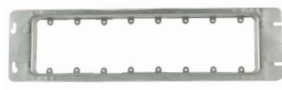

808

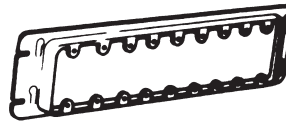

809

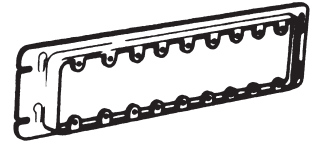

810

Multi-gang handy boxes

Cat. No.	Capacity (cu. in.)	Description	Std. Ctn.
807	36.3	A seven-gang switch ring, 3/4" raised x 4⁹/₁₆" long x 15¹⁵/₁₆" wide Fits Steel City® 706 or 707 outlet boxes and uses GB-7 covers	1
808	41.0	An eight-gang switch ring, 3/4" raised x 4⁹/₁₆" long x 17³/₄" wide Fits Steel City® 707 or 708 outlet boxes and uses GB-8 covers	1
809	46.5	A nine-gang switch ring, 3/4" raised x 4⁹/₁₆" long x 19⁹/₁₆" wide Fits Steel City® 708 or 709 outlet boxes and uses GB-9 covers	1
810	51.5	A ten-gang switch ring, 3/4" raised x 4⁹/₁₆" long x 21³/₈" wide Fits Steel City® 709 or 710 outlet boxes and uses GB-10 covers	1

Multi-gang covers – SB and GB series

Typical mounting arrangement

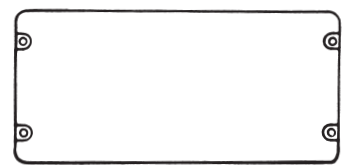
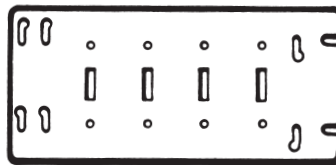
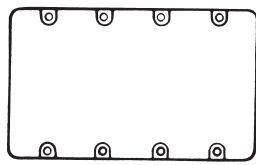
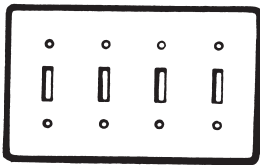

Multi-gang covers — SB series

Cat. No.	Description	Std. Ctn.
SB-2	2-gang cover	1
SB-3	3-gang cover	1
SB-4	4-gang cover	1
SB-5	5-gang cover	1
SB-6	6-gang cover	1
SB-7	7-gang cover	1
SB-8	8-gang cover	1
SB-9	9-gang cover	1
SB-10	10-gang cover	1

Fits Steel City® 132, 133 and 134 series handy boxes (both welded and drawn) and 800 series multi-gang rings.

Multi-gang covers — GB series

Cat. No.	Description	Std. Ctn.
GB-2	2-gang cover	1
GB-3	3-gang cover	1
GB-4	4-gang cover	1
GB-5	5-gang cover	1
GB-6	6-gang cover	1
GB-7	7-gang cover	1
GB-8	8-gang cover	1
GB-9	9-gang cover	1
GB-10	10-gang cover	1

Fits Steel City® 700 series multi-gang boxes.

How to order

1. Indicate style of cover "GB" or "SB"
2. Use symbols for each opening
3. Separate each symbol with a dash (-)
4. Allow 4 to 6 weeks for shipment

Symbols

DR Duplex Receptacle

TS Toggle Switch

SR Single Receptacle — Opening 1.4"

B Blank

TL Twist Lock (4-Wire) — Opening 1.594"

Example:

↑ SB-5:DR ↑ TS ↑ SR ↑ B ↑ TL

Concrete/masonry boxes and accessories

Bars for hanging ceiling boxes, concrete box covers, cover plate, box adapter, 4" Octagon concrete boxes and hanging ceiling boxes



Two bars required for each box.

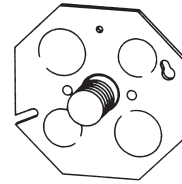

Bars for hanging ceiling boxes

Cat. No.	Length (in.)	Std. Ctn.
HBB 18	18	40
HBB-24	24	40
HBB-30	30	40

Concrete box covers

Cat. No.	Description	Std. Ctn.
911	Flat - 4" octagon Two 1/2" KOs and two 3/4" KOs with 3/8" fixture stud*	25

Fits any Steel City® concrete box.



CBP CBP 3/8 • Thread size: 3/8-18 NPS

Concrete box cover plate





Cat. No.	Description	Std. Ctn.
CBP	No Stud; 3 1/2" and 2 3/4" KOs	25
CBP 3/8	With 3/8" fixture stud; 2 1/2" and 3/4" KOs	25

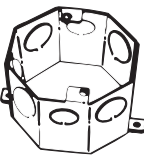
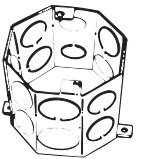
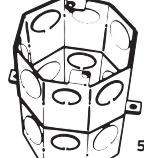
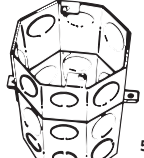
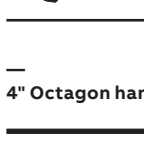

Concrete box adapter

Cat. No.	Description	Std. Ctn.
CBA	For quick mounting and alignment of 4" octagon extension ring on concrete box or hung ceiling box	25

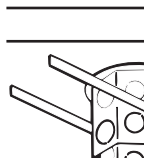
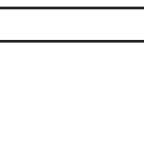
4" Octagon concrete boxes

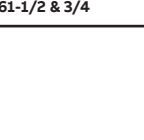
Cat. No.	Depth (in.)	Capacity (cu. in.)	Knockouts	Std. Ctn.
With conduit KOs				
 54531 1/2 3/4	2	23.0	1/2" & 3/4" single row	25
 54541 1/2 3/4	2 1/2	29.0	1/2" & 3/4" single row	25
 54551 1/2 & 3/4 & 1	3	35.0	1/2" & 3/4" single row	20
 54551-3/4 & 1	3	35.0	3/4" & 1" single row	20
 54561 1/2	3 1/2	41.0	1/2" double row	20
 54561-1/2 & 3/4	3 1/2	41.0	1/2" & 3/4" double row	20
 54561-3/4 & 1	3 1/2	41.0	3/4" & 1" double row	20
 54571 1/2 3/4	4	47.0	1/2" & 3/4" double row	10
 54571-3/4 & 1	4	47.0	3/4" & 1" double row	10
 54581 1/2 & 3/4	5	58.0	1/2" & 3/4" double row	10
54591 1/2 & 3/4	6	70.0	1/2" & 3/4" three rows	10

4" Octagon hanging ceiling boxes

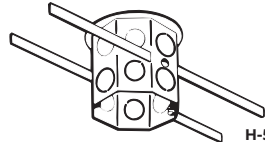
Cat. No.	Depth (in.)	Capacity (cu. in.)	Knockouts	Std. Ctn.
With conduit KOs				
 H-54561-1/2 & 3/4	3 1/2	41.0	1/2" & 3/4" double row	20
H-54561-3/4	3 1/2	41.0	3/4" double row	20

Concrete/masonry boxes and accessories

Gangable masonry boxes



GW 135 G

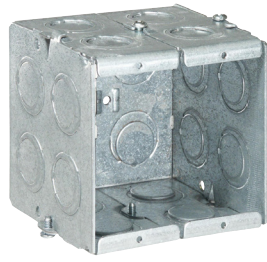

GW 235 G

Gangable masonry boxes



Cat. No.	Depth (in.)	Height (in.)	Length (in.)	Capacity (cu. in.)	Eccentric Knockouts 1/2" & 3/4"			Std. Ctn.
					Each side	Each end	Bottom	
With eccentric conduit KOs								
GW 125 G*	2 1/2	3 3/4	1 15/16	15.0	2	2	2	20
GW 225 G*	2 1/2	3 3/4	3 3/4	31.6	2	4	4	10
GW 325 G*	2 1/2	3 3/4	5 9/16	47.4	2	6	6	5
GW 425 G	2 1/2	3 3/4	7 3/8	64.0	2	8	8	5
GW 525 G	2 1/2	3 3/4	9 3/16	79.0	2	10	10	5
GW-625-G*	2 1/2	3 3/4	11	94.8	2	12	12	1
GW 135 G*	3 1/2	3 3/4	1 15/16	22.0	4	2	2	20
GW 235 G*	3 1/2	3 3/4	3 3/4	46.9	4	4	4	10
GW 335 G	3 1/2	3 3/4	5 9/16	71.0	4	6	6	10
GW 435 G*	3 1/2	3 3/4	7 3/8	93.5	4	8	8	5
GW-535-G	3 1/2	3 3/4	9 3/16	111.7	4	10	10	5
GW-635-G	3 1/2	3 3/4	*11	134.0	4	12	12	1

* Per NEC®, suitable for use without a bonding jumper in circuits above or below 250 volts.

† 4-, 5- and 6-gang supplied with partitions.

Masonry box partitions

Masonry box partitions

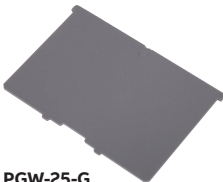
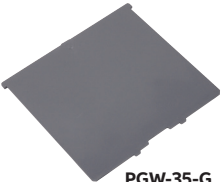

	Cat. No.	Description	Std. Ctn.
	PGW-25-G	Non-metallic partition for 2 1/2"-deep steel tile wall boxes	25
	PGW-35-G	Non-metallic partition for 3 1/2"-deep steel tile wall boxes	25
			

PGW-25-G

PGW-35-G

Concrete/masonry boxes and accessories

Shallow masonry boxes



1-MBS



2-MBS



3-MBS



4-MBS



MBPS

Shallow masonry boxes

Cat. No.	Depth (in.)	Capacity (cu. in.)	Description	Std. Ctn.
1-MBS	2½	16.5	A one-gang masonry box, 2½" deep x 3¾" long x 1⅞" wide Six ½" and two ¾" concentric KOs. Two in each side and one in each end. Uses Steel City® 100 cover.	10
2-MBS	2½	33.0	A two-gang masonry box, 2½" deep x 3¾" long x 3¾" wide Eight ½" and two ¾" concentric KOs. Two in each side and two in each end. Uses Steel City® SB-2 cover.	10
3-MBS	2½	49.0	A three-gang masonry box, 2½" deep x 3¾" long x 5½" wide Ten ½" and ¾" concentric KOs. Three in each side and two in each end. Uses Steel City® SB-3 cover.	5
4-MBS	2½	67.0	A four-gang masonry box, 2½" deep x 3¾" long x 7⅞" wide Twelve ½" and ¾" concentric KOs. Four in each side and two in each end. Uses Steel City® SB-4 cover.	5
MBPS	2½	–	Masonry box partition, 2½" deep x 3¾" wide A low-voltage partition drilled and tapped for mounting. Furnished with two 8/32 screws. For use with 2-MBS, 3-MBS or 4-MBS boxes	50

Deep masonry boxes



1-MB



2-MB



3-MB



4-MB



MBP

Deep masonry boxes

Cat. No.	Depth (in.)	Capacity (cu. in.)	Description	Std. Ctn.
1-MB	3½	23.3	One-gang masonry box, 3½" deep x 3¾" long x 1⅞" wide Eight ½" and ¾" concentric KOs. Two in each side and two in each end. Uses Steel City® 100 series covers.	10
2-MB	3½	46.8	Two-gang masonry box, 3½" deep x 3¾" long x 3¾" wide Twelve ½" and ¾" concentric KOs. Four in each of two sides and two in each end. Uses Steel City® SB-2 cover.	10
3-MB	3½	69.5	Three-gang box, 3½" deep x 3¾" long x 5½" wide Sixteen ½" and ¾" concentric KOs. Six in each of two sides and two in each end. Uses Steel City® SB-3 cover.	5
4-MB	3½	92.0	Four-gang masonry box, 3½" deep x 3¾" long x 7⅞" wide Twenty ½" and ¾" concentric KOs. Eight in each of two sides and two in each end. Uses Steel City® SB-4 cover.	5
MBP	3½	–	Masonry box partition, 3½" deep x 3¾" wide A low-voltage partition drilled and tapped for mounting. Furnished with two 8/32 screws. For use with 2-MB, 3-MB or 4-MB boxes.	50

Concrete/masonry boxes and accessories

1" KO masonry boxes

1" KO masonry box



Cat. No.	Length (in.)	Capacity (cu. in.)	1" Knockouts			Std. Ctn.
			Each side	Each end	Bottom	
Non-gangable single gang						
GW 135 NG-1	1 ⁷ / ₈	22	2	1	2	10

Thru-wall boxes for concrete block

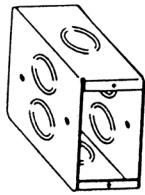

CBTW 4

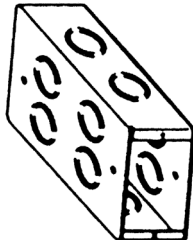

CBTW 6

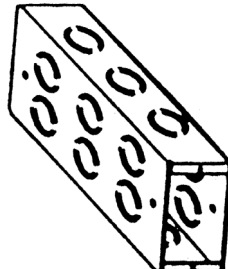

CBTW 8

Thru-wall boxes for concrete block

Cat. No.	Width (in.)	Height (in.)	Depth (in.)	Capacity (cu. in.)	Knockouts (in.)		Std. Ctn.
					Each side Conduit	Each end Conduit	
With concentric conduit KOs							
CBTW 4	2 ¹ / ₈	3 ¹¹ / ₁₆	3 ¹ / ₂	24.0	(2) 1 ¹ / ₂ -3 ³ / ₄	(1) 1 ¹ / ₂ -3 ³ / ₄	10
CBTW 6	2 ¹ / ₈	3 ¹¹ / ₁₆	5 ¹ / ₂	38.0	(4) 1 ¹ / ₂ -3 ³ / ₄	(2) 1 ¹ / ₂ -3 ³ / ₄	10
CBTW 8	2 ¹ / ₈	3 ¹¹ / ₁₆	7 ¹ / ₂	52.3	(6) 1 ¹ / ₂ -3 ³ / ₄	(3) 1 ¹ / ₂ -3 ³ / ₄	10

Welded thru boxes

Welded thru boxes

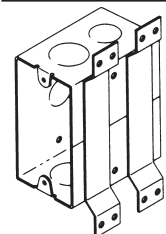

Cat. No.	Capacity (cu. in.)	Description	Std. Ctn.
4-DWS	25.5	3 ⁵ / ₁₆ " deep x 4" long x 2 ¹ / ₈ " wide One 1 ¹ / ₂ " KO and one 3 ³ / ₄ " KO both on top, one 1 ¹ / ₂ " KO bottom side and one 1 ¹ / ₂ " KO on side opposite two flat brackets*	25

Box hangers and supports

Adjustable bar hangers for plaster and drywall

Packaged complete with either...

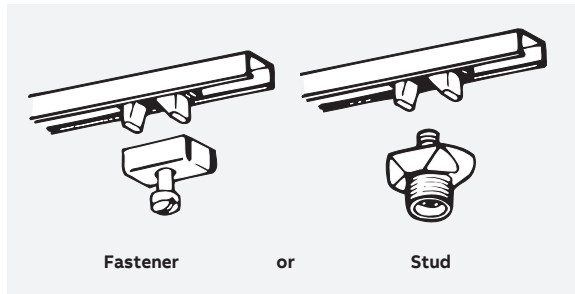

1/2", 3/4", 7/8" Lath and Plaster

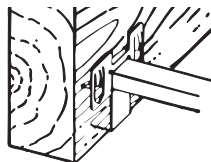
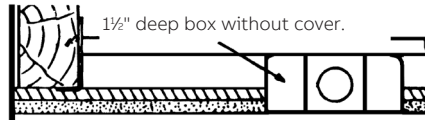

Accurate and automatic positioning on joist.

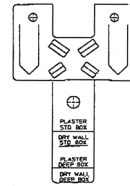

Endplate locator tab is scored and marked for lath and plaster drywall applications with standard and deep boxes.

Ease of installation:

Claws provide temporary support for proper positioning until permanently installed.

Two adjustable lengths:

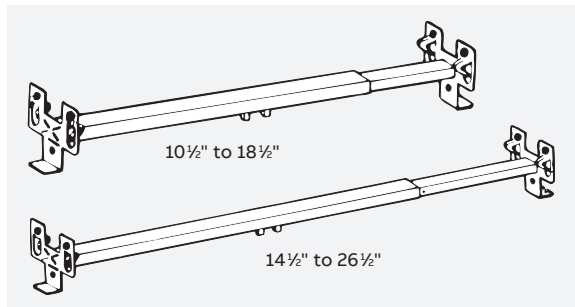

3/8", 1/2", 5/8" Drywall board



Foot straightened gauges for 1 1/2"-deep box with cover or 2 1/8"-deep box without cover. With foot broken off gauges for shallow pan box.



Adjustable bar hangers for plaster and drywall

Cat. No.	Depth of end Plate (in.)	Bar Length (in.)	Stud or fastener	Std. Ctn.
For 3/8", 1/2" and 5/8" wall board and plaster – 50 lb. max. load rating				
6010DW-25	13/16	10 1/2 - 18 1/2	Stud	25
6010ADW-25	13/16	14 1/2 - 26 1/2	Stud	25
6011DW-25	13/16	10 1/2 - 18 1/2	Fastener	25
6011ADW-25	13/16	14 1/2 - 26 1/2	Fastener	25

*Score marks for drywall and plaster depths.

Box hangers and supports

Bar hangers

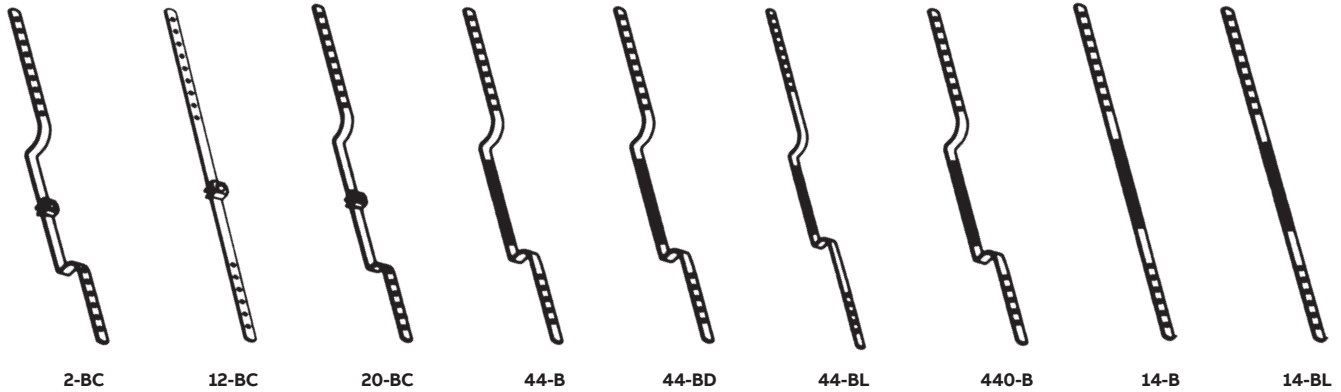

Bar hangers

Cat. No.	Description	Std. Ctn.
2-BC	Deep offset bar hanger. Offset 1½" for mounting boxes with plaster ring. Furnished with clip 21" Long	50
12-BC	Straight bar hanger for mounting pancake boxes. Furnished with clip 20" Long	50
20-BC	Shallow offset bar hanger. Offset 1" for mounting 1½"-deep boxes without rings. Furnished with clips 22" Long	50
44-B	Deep offset bar hanger. Offset 1½" for mounting 1½"-deep boxes with plaster ring to bring cover flush with plaster. Furnished with stovebolt 22" Long	50
44-BD	Extra deep offset bar hanger. Offset 2⅛" for mounting 2⅛"-deep box. Furnished with stovebolt 22" Long	50
44-BL	Deep offset bar hanger. Offset 1½" for mounting 1½"-deep boxes with plaster ring to bring cover flush with plaster. Furnished with stovebolt 26" Long	50
440-B	Shallow offset bar hanger. Offset 1" for mounting 1½"-deep boxes without rings. Furnished with stovebolt 21" Long	50
14-B	Straight bar hanger for mounting ceiling boxes. Furnished with stovebolt 20" Long	50
14-BL	Straight bar hanger for mounting ceiling boxes. Furnished with stovebolt 24" Long	50

Far-side box support

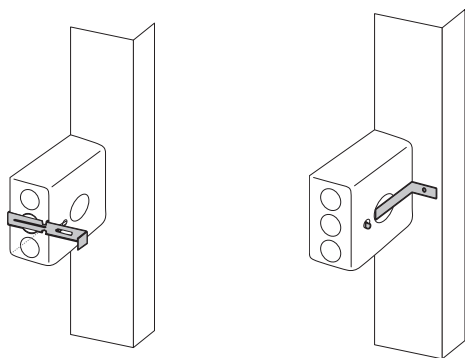

Features and benefits:

- Provides side support for electrical boxes
- Works with most electrical boxes for 2½", 3½" and 4" metal stud depths

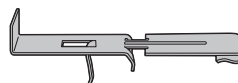

Fig. 1



Fig. 2

Far-side box support

Cat. No.	Fig. No.	Description	Std. Ctn.
SS1-TB	1	Far-side box support	100
50-SC	2	Box brace for 4" square or octagonal box	100

Box hangers and supports

Floor-mounted box supports

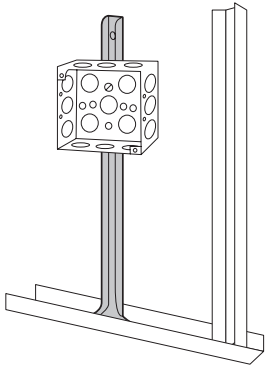

Fig. 1

Features and benefits:

- Mounts on metal or wood studding
- Used as conduit rack or spacer for rigid conduit, IMC or EMT
- Ideal for schools, hospitals, industrial and commercial jobs
- Galvanized steel

Floor-mounted box supports

Cat. No.	Fig. No.	Description	Std. Ctn.
7502	1	Footed box supports, 20" height	25
7503-SC	1	Footed box supports, 30" height	50

Pipe nailers



Pipe nailers

Cat. No.	Description	Std. Ctn.
PN-3-1	1"	1,000

Box hangers and supports

Snap-on box clip

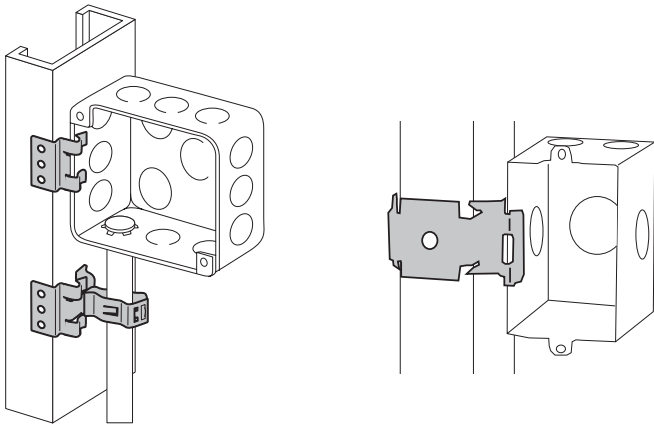

Features and benefits:

- Fits most electrical boxes requiring plaster rings
- Fits most metal stud sizes
- Will not move on stud
- Wider part for more secure fastening
- No screws required
- Support leg braces box against stud
- Installs easily with a hammer
- Adjustable offset enables box to protrude through drywall sizes: 1/4", 3/8", 1/2", 5/8" or 3/4"

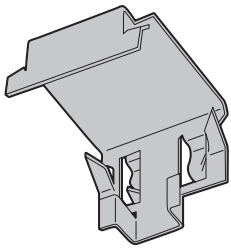

Fig. 1

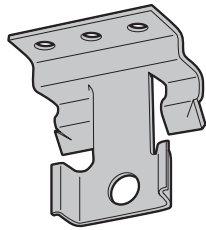

Fig. 2

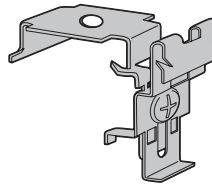

Fig. 3

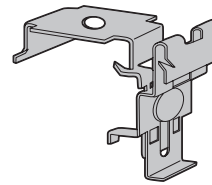

Fig. 4

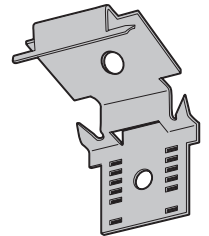

Fig. 5

Snap-on box clip

Cat. No.	Fig. No.	Description	Std. Ctn.
SSF-SMX	1	Snap-on box support for mounting to stud	100
SSF-SK	2	Screw to stud, box support	100
SF-SFA	3	Snap-on box support for mounting to stud, adjustable	25
SSF-SF0	4	Snap-on box support for mounting to stud, riveted for flush to stud face	25
SSF-SF1/4	4	Snap-on box support for mounting to stud, riveted for 1/4" drywall	25
SSF-SF3/8	4	Snap-on box support for mounting to stud, riveted for 3/8" drywall	25
SSF-SF1/2	4	Snap-on box support for mounting to stud, riveted for 1/2" drywall	25
SSF-SF5/8	4	Snap-on box support for mounting to stud, riveted for 5/8" drywall	25
SSF-SF3/4	4	Snap-on box support for mounting to stud, riveted for 3/4" drywall	25
SSF-SFT	5	Snap-on box support for mounting to stud with 1/4"-20 thread impression	25

Stud wall and drywall accessories

Grounding devices



GEE

Grounding clip

- For grounding switch and outlet boxes using non-metallic sheathed cables with ground wire
- Grounds #12 and #14 copper and #12 aluminum conductors

Grounding Pigtail

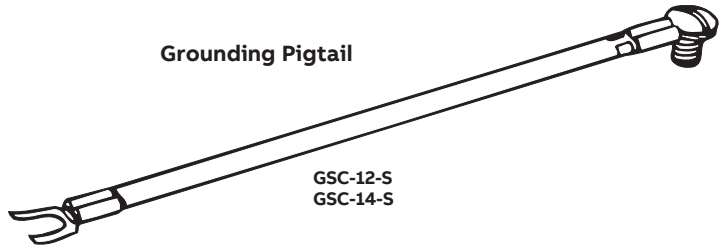

GSC-12-S
GSC-14-S

Grounding screw and wire

- A prelooped 6"-long bare or insulated copper ground wire attached to a 10-32 x 3/8" hexagon-head washer-face screw, colored green

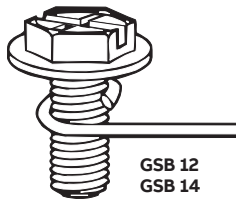

GSB 12
GSB 14

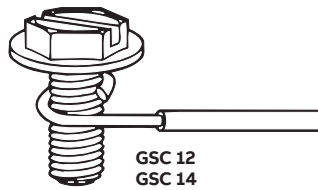

GSC 12
GSC 14

Grounding screw

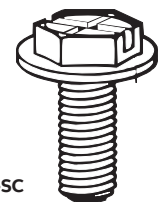

GS 1-SC

Grounding devices

Cat. No.	Description	Std. Ctn.	Unit Pkg.
Grounding clip			
GEE	Zinc-plated, spring-steel, colored green accommodates #12 and #14 copper and #12 aluminum solid conductors in non-metallic sheathed cable. Also approved for connecting bonding jumper from receptacle to grounded metal device box. 50 per unit package	1,000	-
Grounding screws and pigtails			
GSC 12	10-32 x 3/8" slotted hexagon-head washer-face ground screw with green dye finish and a six-inch solid copper #12 AWG insulated wire	1,000	100
GSC-12-S*	#12 AWG insulated eight-inch stranded pigtail with a captive 10-32 x 3/8" round head screw on one end and a fork-tongue terminal on the other end	1,000	100
GSC-12-10 1/2	10-32 x 3/8" slotted hexagon-head washer-face ground screw with green dye finish and a 10 1/2 inch solid-copper #12 AWG insulated wire	1,000	100
GSC 14	10-32 x 3/8" slotted hexagon-head washer-face ground screw with green dye finish and a six-inch solid-copper #14 AWG insulated wire	1,000	100
GSC 14 S*	#14 AWG insulated eight-inch stranded pigtail with a captive 10-32 x 3/8" round head screw on one end and a fork-tongue terminal on the other end	1,000	100
GSB 12	10-32 x 3/8" slotted hexagon-head washer-face ground screw with green dye finish and a six-inch solid-copper #12 AWG bare wire	1,000	100
GSB 14	10-32 x 3/8" slotted hexagon-head washer-face ground screw with green dye finish and a six-inch solid-copper #14 AWG bare wire	1,000	100
GS 1-SC	10-32 x 3/8" slotted hexagon-head washer-face screw with green dye finish. Provides positive ground continuity in boxes with a #10-32 tapped hole	1,000	100

* Eight-inch stranded pigtail is also available with a captive 10-32 x 3/8" round-head screw on one end and a fork-tongue terminal on the other end.

Stud wall and drywall accessories

Channel bar

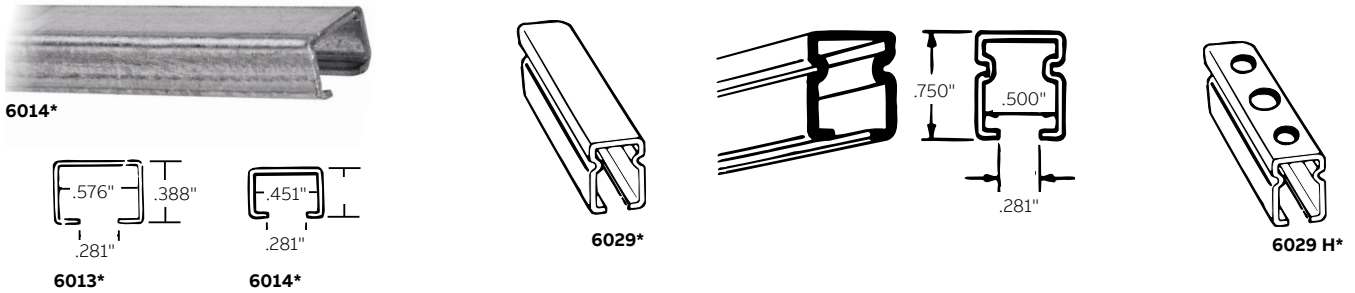

Channel bar

Cat. No.	Description	Min. Order (ft.)	Std. Ctn.
Mounts fixtures, boxes and conduits in suspended ceilings			
6013*	20 ga. single channel bar	100	100
6014*	18 ga. single channel bar	100	100
6029*	16 ga. (.060") ribbed	100	100
6029 H*	16 ga. (.060") ribbed — with holes for #12 sheet-metal screw and 1/4" threaded rod	100	100

*10-ft. lengths.

Box and channel fasteners

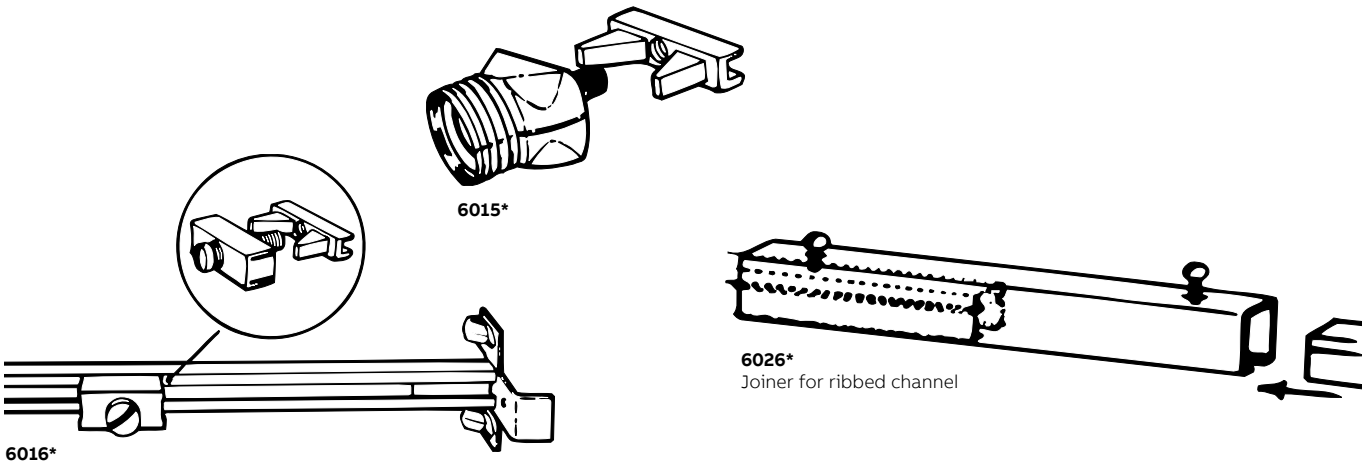

Box and channel fasteners

Cat. No.	Description	Min. Order (ft.)	Std. Ctn.
6015*	Stud and carrier 3/8-18 NPS threading	100	100
6016*	Fastener and carrier	100	100
6026*	Joiner for 6029 channel	100	100

* Minimum order 100 pieces.

Stud wall and drywall accessories

Conduit-to-metal stud

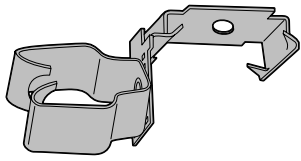

Fig. 1

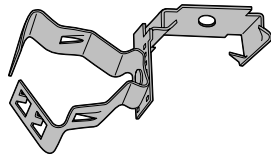

Fig. 2

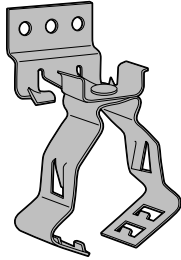

Fig. 3

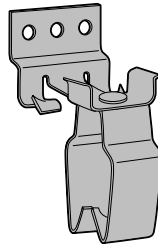

Fig. 4

Features and benefits:

- Attaches securely to most metal stud sizes
- Riveted to accommodate your drywall requirements

Conduit-to-metal stud

Cat. No.	Fig. No.	Description	Std. Ctn.
SF-SF-S1/2	1	Snap on stud, push-in conduit clip, 1/2" conduit	25
SSF-SF-S3/4	1	Snap on stud, push-in conduit clip, 3/4" conduit	25
SSF-SF-S1	1	Snap on stud, push-in conduit clip, 1" conduit	25
SSF-SF-C3/8	2	Snap on stud, conduit support clip, 3/8" conduit or MC/AC cable	25
SSF-SF-C1/2 3/4	2	Snap on stud, conduit support clip, 1/2"- 3/4" conduit	25
SSF-SF-C1	2	Snap on stud, conduit support clip, 1" conduit	25
SSF-SK-C1/2 3/4	3	1/2"-3/4" finger close conduit clip	25
SSF-SK-C1	3	1" finger close conduit clip	25
SSF-SK-S1/2	4	1/2" snap-in conduit clip	25
SSF-SK-S3/4	4	3/4" snap-in conduit clip	25
SSF-SK-S1	4	1" snap-in conduit clip	25

Easy-snap grommet

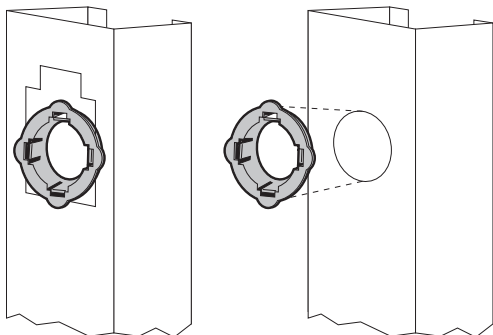

Features and benefits:

- Fits any size or shape metal stud hole
- Provides complete 360° protection for cable

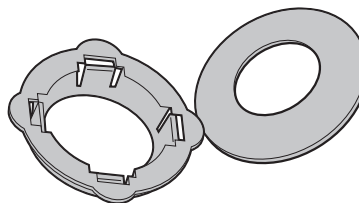

Fig. 1

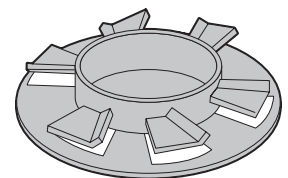

Fig. 2

Easy-snap grommet

Cat. No.	Fig. No.	Description	Std. Ctn.
1300	1	Plastic bushing for metal stud 1" trade size opening (1 ¹¹ / ₃₂ ")	100
1216-EN	2	Twisted universal bushing for metal stud	50

Stud wall and drywall accessories

Through-stud cable conduit support

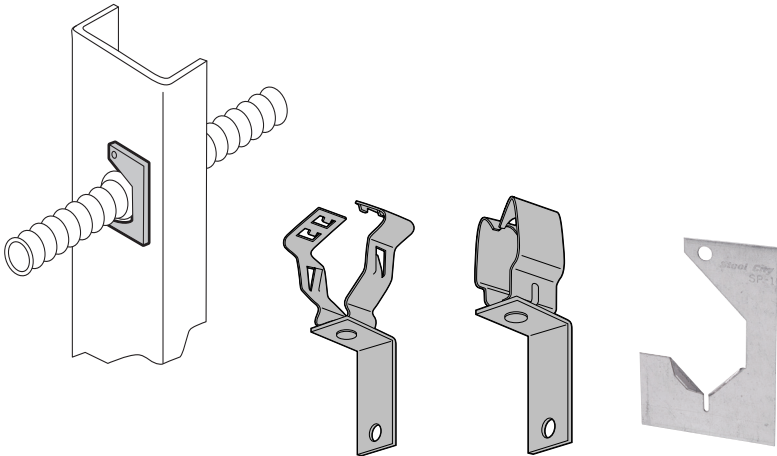

Fig. 1

Fig. 2

Fig. 3

Features and benefits:

- A quick means of support for horizontal runs of conduits or MC/AC through metal stud
- Installs easily with a screw gun
- SSF-SPI enables ENT conduit and MC/AC cable to be easily pulled through metal stud

Through-stud cable conduit support

Cat. No.	Fig. No.	Description	Std. Ctn.
SSF-SAB-C1/2 3/4	1	1/2" or 3/4" finger close conduit clip	25
SSF-SAB-C3/8	1	Finger-close conduit clip 14-2 thru 12-3 MC/AC cable and 3/8" conduit	25
SSF-SAB-S1/2	2	Snap-in conduit clip – 1/2" conduit	25
SSF-SAB-S3/4	2	Snap-in conduit clip – 3/4" conduit	25
SSF-SPI	3	Supports up to 1" conduit	100

Low-voltage mounting brackets – screw-on support

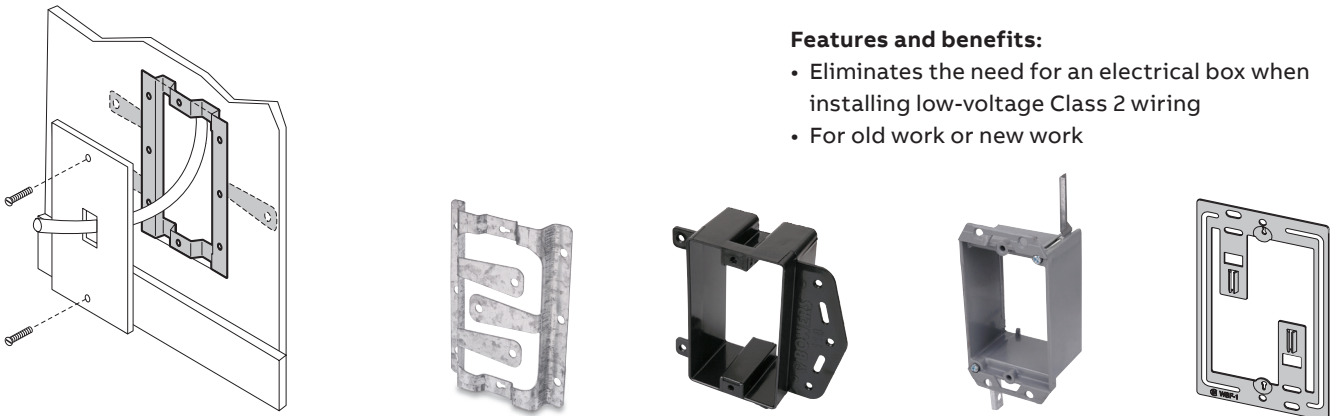

Fig. 1

Fig. 2

Fig. 3

Fig. 4

Features and benefits:

- Eliminates the need for an electrical box when installing low-voltage Class 2 wiring
- For old work or new work

Low-voltage mounting brackets – screw-on support

Cat. No.	Fig. No.	Description	Std. Ctn.
SSF-SLV	1	Old-work or new work low-voltage bracket	100
VN1	2	Non-metallic single-gang new-work low-voltage bracket	50
VN2	-	Non-metallic two-gang new-work low-voltage bracket	50
VW1	3	Non-metallic single-gang old-work low-voltage bracket	50
VW2	-	Non-metallic two-gang old-work low-voltage bracket	50
WBF-1	4	Low-voltage mounting bracket with screws	100

Stud wall and drywall accessories

Cable support

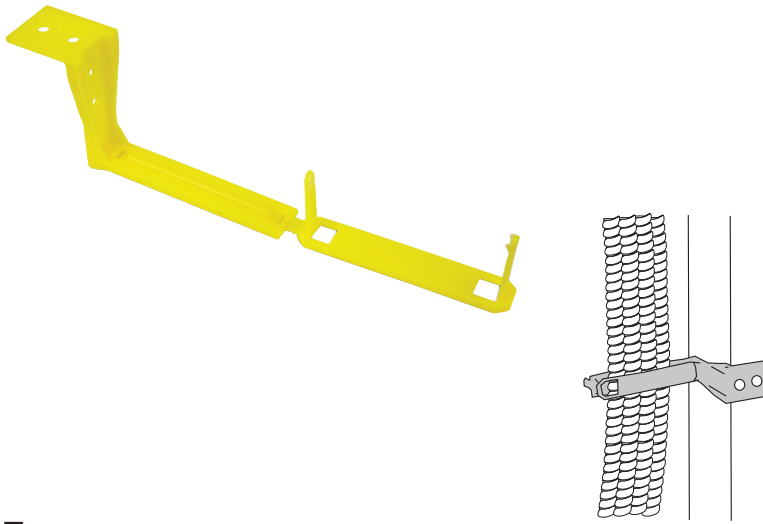

Features and benefits:

- Supports up to four runs of MC and AC cable and up to six runs of non-metallic sheathed cable
- Installs with nails or staples or sheet-metal screws
- Complies with NEC® 300-4d for all wood and metal studs
- Made with high-strength plastic

Cable support

Cable Type	Cable Size	Max. Qty./Fastener
Non-metallic sheathed cable	#14-2, #12-2, #10-2, #14-3, #12-3 and #10-3 with ground	6
Non-metallic	#8-2 and #6-2 with ground	4
Metallic clad (MC) cable and #10-4 with ground	#14-2, #12-2, #10-2, #14-3, #12-3, #10-3, #14-4, #12-4	4
Armored cable (AC)	#14-4, #12-2, #10-2, #8-2, #14-3, #12-3, #10-3, #14-4, #12-4 and #10-4 with ground	4
Flexible conduit (BX)	⁵ / ₁₆ , ³ / ₈	4

Screw-on conduit support



Fig. 1

Features and benefits:

- Supports 1/2" and 3/4" EMT conduit and MC/AC cable
- Works with wood or metal stud
- Preset bend provides alignment with knockouts for 1 1/2"-deep boxes or 2 1/8"-deep boxes

Screw-on conduit support

Cat. No.	Fig. No.	Description	Std. Ctn.
SSF-SS1/2 3/4	1	1/2" and 3/4" EMT conduit and MC/AC to metal or wood stud. For 1 1/2"-deep box	100
SSF-SS1/2 3/4D	1	1/2" and 3/4" EMT conduit metal or wood stud. For 2 1/8"-deep box	100

Stud wall and drywall accessories

Device leveler and retainer

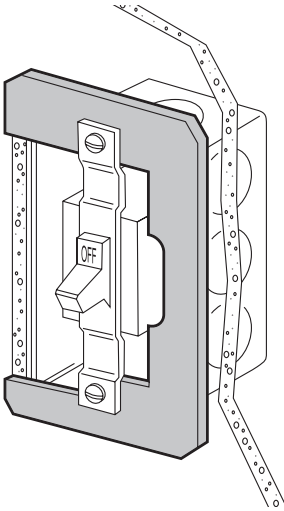

Fig. 1

Features and benefits:

- Use for oversized drywall openings
- Prevents broken cover plates
- Stops device from being pushed back in wall
- Makes floating device rigid

Device leveler and retainer

Cat. No.	Fig. No.	Description	Std. Ctn.
SSF-SR	1	Single-gang device leveler and retainer	100

NEC and National Electrical Code are registered trademarks of the National Fire Protection Association, Inc.

Protector plates

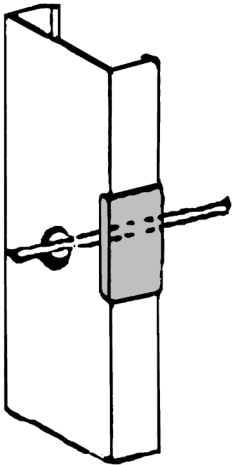

Fig. 1

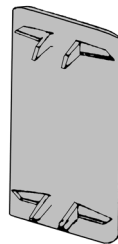

Fig. 2

Features and benefits:

- Protects cable(s) from damage when installing drywall or paneling
- No nails or screws required
- Fits all stud sizes
- Both products meet requirements for NEC® 300-4
- ST66 legs are crimped with pliers to stud to provide secure fit

Protector plates

Cat. No.	Fig. No.	Description	Std. Ctn.
SSF-ST66	1	Protector plate for metal stud	100
66EP	2	Protector plate for wood stud	100

Index & useful information

Order code classification

Part No.	GID Code	Page No.	Part No.	GID Code	Page No.	Part No.	GID Code	Page No.
51	7TAA001480R0000	19	104-W-FB-3/4	7TAA001450R0003	52	3G4D B 1/2	7TAA001600R0019	55
52	7TAA001480R0003	19	106-3/4	7TAA001450R0004	52	3G4D V 1/2	7TAA001600R0020	55
53	7TAA001490R0005	20	106-FB-1/2	7TAA001450R0005	52	4-DWS	7TAA001600R0022	60
72	7TAA001500R0026	21	106-FB-3/4	7TAA001450R0006	52	4-GC	7TAA001560R0001	55
469	7TAA001180R0001	42	12-BC	7TAA001620R0000	62	4-GCB	7TAA001570R0006	55
475	7TAA001180R0007	42	1216-EN	7TAA0011540R0000	67	4-GCS	7TAA001570R0007	55
476	7TAA001180R0008	42	132-W-1/2	7TAA001600R0001	53	4-MB	7TAA001530R0006	59
478	7TAA001980R0135	42	132-W-AB-1/2	7TAA001600R0002	53	4-MBS	7TAA001540R0004	59
649	7TAA001270R0000	50	132-W-FB-1/2	7TAA001600R0003	53	4-O-ULC	7TAA001980R0073	30
655	7TAA001270R0003	50	132-W-FB-3/4	7TAA001980R0021	53	4-OD-EXT-1/2	7TAA001370R0002	32
807	7TAA001580R0011	56	132-W-FBC	—	53	4-OD-EXT-SPL	7TAA001370R0003	32
808	7TAA001580R0012	56	134-BW	7TAA001600R0010	53	4-OD-FB-MXN	7TAA001980R0074	30
809	7TAA001580R0013	56	14-B	7TAA001620R0001	62	4-OD-LCB	7TAA001370R0004	30
810	7TAA001580R0014	56	14-BL	7TAA001620R0002	62	4-OD-U-MXN	7TAA001980R0076	30
911	7TAA001980R0301	57	2-BC	7TAA001620R0003	62	4-OW-LC-BHC	7TAA001980R0080	30
1300	7TAA0011540R0001	67	2-GC	7TAA001570R0000	55	4-OW-MXN	7TBA001370R0006	30
6013	7TBA001980R0254	66	2-GCB	7TAA001580R0000	55	4-S-WR-1/2	7TAA001980R0084	41
6014	7TBA005920R0000	66	2-GCS	7TAA001580R0001	55	4-SDW-FB-MXN	7TAA001060R0001	40
6015	7TBA001330R0001	66	2-MB	7TAA001530R0002	59	4-SDW-LC	7TAA001070R0000	40
6016	7TBA001330R0002	66	2-MBS	7TAA001540R0001	59	4-SDW-MXN	7TAA001070R0001	40
6026	7TAA001330R0003	66	20-BC	7TAA001980R0051	62	4-SS-WR-1/2	7TAA001070R0002	41
6029	7TBA005920R0001	66	210-L	7TAA001360R0000	27	4-SW-1/2-2BC	7TAA001070R0003	40
7502	7TAA001320R0005	63	24-C-6	7TAA001390R0000	27	4-SW-AB-1/2	7TAA001070R0004	40
25151 1/2	7TAA001360R0003	28	24151-NV	7TAA001360R0001	28	4-SW-LC	7TAA001070R0005	40
52151 1/2	7TAA001010R0008	37	241511/2-25	7TAA001350R0001	28	4-SW-MXN	7TAA001980R0097	40
52171 3/4	7TAA001000R0011	38	24151N-25	7TAA001360R0002	28	401-CS	7TAA001120R0000	41
53151 1/2	7TAA001080R0006	43	24C1-25	7TAA001390R0001	27	403-T	7TAA001130R0000	41
53151 3/4	7TAA001080R0008	43	271-FB-MXN	7TAA001980R0063	23	405-B	7TAA001130R0001	41
54151 1/2	7TBA001340R0007	29	271-FBC	7TAA001500R0001	23	4070CFB-BHL	7TAA001360R0015	35
54151 3/4	7TBA001350R0022	29	2G 1/2 3/4	7TAA001550R0000	53	410-LC	7TAA001350R0021	26
54171 3/4	7TAA001350R0039	29	2G4D 1/2 & 3/4	7TAA001600R0011	41	44-B	7TAA001620R0004	62
54561 1/2	7TAA001400R0005	57	2G4DV 1/2 & 3/4	7TAA001600R0014	41	44-BD	7TAA001620R0005	62
56111	7TBA001340R0011	26	2G4DV 1/2 3/4	7TAA001600R0014	55	44-BL	7TAA001620R0006	62
58351 1/2	7TAA001430R0012	51	3-GC	7TAA001560R0000	55	440-B	7TAA001620R0007	62
58361 1/2	7TAA001420R0003	51	3-GCB	7TAA001570R0001	55	449-BW	7TAA001180R0000	42
58361 3/4	7TAA001430R0013	51	3-GCS	7TAA001570R0002	55	470-BW	7TAA001980R0125	42
58371 1/2	7TAA001420R0004	51	3-MB	7TAA001530R0004	59	471-NEC	7TAA001180R0003	42
58371 3/4	7TAA001430R0016	51	3-MBS	7TAA001540R0002	59	472-NEC	7TAA001180R0005	42
59361 1/2	7TAA001430R0017	52	3-O-B-1/2	7TAA001360R0004	28	473-NEC	7TAA001180R0006	42
59361 3/4	7TAA001440R0014	52	3-O-B-MXN	7TAA001370R0000	28	474-BW	7TAA001980R0131	42
68361 1/2	7TAA001440R0018	51	3-O-LCE	7TAA001350R0003	28	477-NEC	7TAA001980R0134	42
68371 1/2	7TAA001430R0018	51	3-O-LCH	7TAA001980R0067	28	479-GFI	7TAA001180R0010	42
521911234	7TAA001590R0008	12	3-O-SPL	7TAA001370R0001	28	480-BW	7TAA001180R0011	42
521911234	7TAA001590R0008	38	300-DR	7TAA001390R0005	31	481-BW	7TAA001180R0012	42
531711234	7TAA001080R0010	43	300-SR	7TAA001390R0007	31	482-NEC	7TAA001180R0013	42
1-MB	7TAA001530R0000	59	36115 C30	7TBA001350R0004	26	4G 1/2 3/4	7TAA001550R0002	53
1-MBS	7TAA001540R0000	59	36125 D	7TAA001360R0008	26	4G4D 1/2	7TAA001600R0023	55
102-W-LB-1/4	7TAA001980R0009	52	3G 1/2 3/4	7TAA001550R0001	53	4G4D B 1/2	7TAA001600R0024	55
103-W-AB	7TAA001440R0000	52	3G4D 1/2	7TAA001600R0018	55	4G4D V 1/2	7TAA001600R0025	55

Index

Order code classification

Part No.	GID Code	Page No.	Part No.	GID Code	Page No.	Part No.	GID Code	Page No.
5 GC	7TAA001560R0002	55	52-C-ADJ	7TAA001150R0000	45	52171-EW-SSX	7TBA001060R0024	38
5 GCB	7TAA001580R0005	55	52-C-ADJ2	7TAA001150R0003	45	52171-EW-SSX	7TBA001060R0024	39
5 GCS	7TAA001580R0006	55	52-FB-3/4	7TAA001500R0005	19	52171-EXTOWRD	7TAA001590R0006	36
5-SDW-FB-1	7TAA001210R0000	47	52-FBC	7TAA001500R0007	19	52171-EXTRD	7TAA001590R0007	36
50-SC	7TAA001320R0000	62	52-LCNE	7TAA001500R0009	19	52171-OW	7TAA001060R0025	37
500-K-3/4	7TAA001390R0009	32	52-NE	7TAA001500R0010	19	52171-SVT	7TAA001060R0021	39
500-TL	7TAA001390R0011	32	52-NE-3/4	7TAA001500R0011	19	52171-VN	7TAA001050R0020	37
501-CA	7TAA001390R0013	32	52141-1/2	7TAA001010R0007	37	52171-X-SSX	7TBA001060R0029	39
501-CS	7TAA001390R0017	32	52151 1/2 3/4	7TAA001000R0006	37	521711234E	7TAA001000R0013	38
51-FB	7TAA001500R0002	19	52151 BN	7TAA001060R0005	37	521711234EP	7TAA001050R0023	38
51-LC	7TAA001500R0003	19	52151 BX	7TAA001050R0005	39	521711234EP	7TAA001050R0023	38
51-NE	7TAA001500R0004	19	52151 CV 1/2 3/4	7TAA001040R0006	38	52171MSP	7TAA001060R0027	38
52 C 0	7TAA001110R0023	43	52151 CV 3/4	7TAA001060R0006	38	52171MSXP	7TAA001060R0028	39
52 C 00	7TAA001110R0024	43	52151 CVN	7TAA001060R0007	37	521911234CV	7TAA001590R0010	12
52 C 1	7TAA001100R0006	43	52151 CVX	7TAA001050R0006	39	521911234CV	7TAA001590R0010	38
52 C 10	7TAA001120R0008	43	52151 MS 1/2 & 3/4	7TAA001050R0007	38	521911234CVRD	7TAA001590R0011	12
52 C 13	7TAA001100R0007	43	52151 MS N	7TAA001060R0008	37	521911234CVRD	7TAA001590R0011	36
52 C 14	7TAA001100R0008	43	52151 MS X	7TAA001040R0007	39	521911234RD	7TAA001590R0012	12
52 C 14 5/8	7TAA001100R0009	43	52151 N	7TAA001060R0009	37	521911234RD	7TAA001590R0012	36
52 C 15	7TAA001110R0025	43	52151 VN	7TAA001050R0008	37	52C1-VT	7TAA001120R0007	39
52 C 16	7TAA001110R0026	43	52151 VX	7TAA001050R0009	39	52C20-25	7TAA001110R0052	43
52 C 18	7TAA001110R0027	43	52151 X	7TAA001050R0010	39	52C5011/2-25	7TAA001100R0014	43
52 C 19	7TAA001110R0028	43	52151-1/2 & 3/4-EW	7TAA001000R0007	37	52C512-25	7TAA001110R0059	43
52 C 1RD	7TAA001590R0000	36	52151-1234RD	7TAA001590R0002	36	52CM13	7TAA001140R0000	44
52 C 21	7TAA001110R0029	43	52151-3/4	7TAA001010R0009	37	52CM14	7TAA001140R0001	44
52 C 3 1	7TAA001110R0030	43	52151-3/4-W	7TAA001010R0010	37	52CM14-5/8	7TAA001140R0002	44
52 C 37	7TAA001130R0003	43	52151-EF-SSX	7TBA001060R0011	39	52CMD17	7TAA001140R0003	44
52 C 49 1/2	7TAA001120R0013	43	52151-SVT	7TAA001060R0010	39	52CMD18	7TAA001140R0004	44
52 C 52 1/2	7TAA001120R0015	43	52151-V-1/2 & 3/4	7TAA001040R0012	38	52CMD18-5/8	7TAA001140R0005	44
52 C 53 1 1/2	7TAA001110R0036	43	52151-X-SSX	7TBA001060R0016	39	53-3/4-BW	7TAA001500R0013	20
52 C 54 2	7TAA001110R0037	43	521511234EWGB	7TAA001000R0008	37	53-FB	7TAA001500R0014	20
52 C 6	7TAA001110R0038	43	521511234EWGBP	7TAA001060R0012	37	53-FB-MXN	7TAA001980R0199	20
52 C 62	7TAA001110R0039	43	521511234EWP	7TAA001060R0013	38	53-FBC	7TAA001500R0015	20
52 PS 1	7TAA001320R0002	41	521511234P	7TAA001070R0013	37	53-LCNE	7TAA001980R0200	20
52 PS 2	7TAA001330R0000	41	52151B1234	7TAA001050R0011	37	53-NE	7TAA001500R0016	20
52-3/4-BW	7TAA001490R0001	19	52151CVNP	7TAA001070R0015	37	53-NE-3/4	7TAA001500R0017	20
52-C-17-25	7TAA001110R0046	43	52151DV12	7TAA001050R0014	38	53-OWE	7TAA001480R0011	20
52-C-18-5/8-25	7TAA001100R0013	43	52151XP	7TAA001060R0015	39	53-OWE-MXN	7TAA001500R0019	20
52-C-3-1-1/4	7TAA001110R0031	43	52171 1	7TAA001000R0010	38	53-OWEC	7TAA001500R0018	20
52-C-3-1/2-25	7TAA001110R0056	43	52171 MS 1/2 3/4	7TAA001050R0018	38	53151 1/2 3/4	7TAA001080R0007	43
52-C-3-25	7TAA001110R0053	43	52171 MSX	7TAA001040R0015	39	531511234UB	7TAA001080R0009	43
52-C-3-3/4	7TAA001110R0032	43	52171 N	7TAA001060R0020	37	53171 1	7TAA001090R0006	43
52-C-36	7TAA001120R0011	43	52171 V 1/2 & 3/4	7TAA001050R0019	38	53171-1234RD	7TAA001590R0015	36
52-C-49-1	7TAA001120R0012	43	52171 X	7TAA001050R0021	39	54 C 1	7TAA001380R0002	31
52-C-49-1-1/4	7TAA001110R0033	43	52171-1234RD	7TAA001590R0004	36	54 C 14	7TAA001390R0020	31
52-C-49-3/4	7TAA001110R0034	43	52171-B-1/2 & 3/4	7TAA001060R0022	38	54 C 3	7TAA001390R0021	31
52-C-52-1	7TAA001120R0014	43	52171-CV-1/2 & 3/4	7TAA001040R0014	38	54 C 3 1	7TAA001390R0022	31
52-C-52-1-1/4	7TAA001110R0035	43	52171-CV-1234RD	7TAA001590R0005	36	54 C 3 1 1/4	7TAA001390R0023	31
52-C-52-3/4	7TAA001120R0016	43	52171-CVX	7TAA001050R0017	39	54 C 3 1/2	7TAA001390R0024	31

Index

Order code classification

Part No.	GID Code	Page No.	Part No.	GID Code	Page No.	Part No.	GID Code	Page No.
54 C 6	7TAA001380R0003	31	54C1-VT	7TAA001390R0019	39	72 C 3	7TAA001240R0013	48
54 C 7	7TAA001390R0025	31	55151 1/2 3/4	7TBA001350R0046	32	72 C 49 3/4	7TAA001240R0018	50
54-FB-MXN	7TAA001500R0022	21	551511/2-25	7TBA001350R0047	32	72 C 50 1 1/2	7TAA001230R0022	50
54-FBC	7TAA001500R0023	21	56111-CFB	7TAA001340R0012	26	72 C 51 2	7TAA001230R0023	50
54-LC	7TAA001500R0024	21	56111-CFB	7TAA001340R0012	34	72 C 52 3/4	7TAA001240R0020	50
5401-LR	7TAA001390R0027	31	56111CFB-BHL	7TAA001370R0037	35	72 C 53 1 1/2	7TAA001230R0024	50
5402-LR	7TAA001390R0028	31	58351 B 1/4	7TAA001450R0009	51	72 C 54 2	7TAA001240R0021	50
54151 1/2 & 3/4	7TBA001340R0008	29	58361 V 1/2	7TAA001430R0014	51	72 C 6	7TAA001240R0022	48
54151 A	7TBA001360R0016	29	58371 T 1/2	7TAA001440R0009	51	72 C 62	7TAA001230R0025	49
54151 AF	7TBA001350R0023	30	58371V1/2-25	7TAA001440R0011	51	72 PD 1	7TAA001320R0004	48
54151 AL	7TAA001360R0017	29	5G 1/2 3/4	7TAA001550R0003	53	72 PD 2	7TAA001330R0004	48
54151 J 1/2	7TBA001360R0018	29	6 GC	7TAA001570R0011	55	72 PS 1	7TAA001330R0005	48
54151 L 1/2	7TAA001360R0019	29	6 GCB	7TAA001580R0009	55	72 PS 2	7TAA001330R0006	48
54151 N	7TBA001350R0024	29	6 GCS	7TAA001580R0010	55	72-C	7TAA001980R0264	21
54151 NE	7TBA001350R0025	29	601-CD	7TAA001240R0005	48	72-C-3-1	7TAA001240R0014	48
54151 NF	7TBA001350R0026	30	6010ADW-25	7TBA001350R0052	61	72-C-3-1/2	7TAA001240R0015	48
54151 NG	7TBA001370R0012	30	6010DW-25	7TBA001350R0053	61	72-C-3-3/4	7TAA001240R0016	48
54151 NL	7TAA001350R0027	29	6011ADW-25	—	61	72-C-49-1	7TAA001250R0006	50
54151 NO	7TBA001350R0028	30	6011DW-25	7TBA001360R0039	61	72-C-49-1-1/4	7TAA001240R0017	50
54151 NP	7TBA001350R0029	30	6029 H	7TBA005920R0002	66	72-C-49-1/2	7TAA001250R0007	50
54151 NV	7TBA001350R0030	29	604-B	7TAA001250R0000	48	72-C-52-1	7TAA001250R0008	50
54151 V 1/2	7TBA001350R0031	29	604-F	7TAA001250R0001	48	72-C-52-1-1/4	7TAA001240R0019	50
54151-1/2-CFB-BP	7TAA001370R0015	34	608-C	7TAA001250R0004	48	72-C-52-1/2	7TAA001250R0009	50
54151-CFB	7TAA001340R0009	34	650-BW	7TAA001270R0001	50	72-FB-MXN	7TAA001980R0265	21
54151-VT	7TAA001370R0030	39	657-NEC	7TAA001270R0004	50	72-OC	7TAA001500R0027	21
54151AV-25	7TBA001360R0027	29	663-BW	7TAA001270R0005	50	72-ONS-MXN	7TAA001980R0267	21
54151CFB-BHL	7TAA001350R0032	35	665-BW	7TAA001270R0006	50	72-OWE	7TAA001980R0268	21
54151CFB-BHL-OW	7TAA001350R0033	33	66EP	7TBA010840R0001	70	72151 MS 1/2 3/4	7TAA001220R0000	47
54171 1	7TAA001370R0031	29	68 C 1	7TAA001460R0028	52	72151 MS 1/2 3/4	7TAA001220R0000	47
54171 1/2 3/4	7TAA001350R0038	29	68 C 30	7TAA001460R0029	52	72151-1/2 & 3/4-E	7TAA001200R0004	47
54171 NL	7TAA001360R0031	29	68 C 5	7TAA001460R0030	52	72151MSP	7TAA001220R0002	47
	7TAA001350R0042	34	68 C 6	7TAA001460R0031	52	72151MSX	7TAA001210R0002	47
54171-CFB	7TAA001350R0040	34	68 C 7	7TAA001460R0032	52	72151MSXP	7TAA001980R0273	47
54171-F-CFB	7TAA001350R0041	34	6G 1/2 3/4	7TAA001550R0004	53	72171 1	7TAA001190R0004	47
541711/2-25	7TAA001350R0043	29	707-SPL	7TAA001550R0010	54	72171 1 1/4	7TAA001200R0005	47
54171N-25	7TAA001360R0032	29	708-SPL	7TAA001550R0011	54	72171 3/4 1	7TAA001190R0007	47
54171NV-25	7TAA001360R0035	29	709-SPL	7TAA001550R0012	54	72171 MS 1/2 3/4	7TAA001210R0004	47
54531 1/2 3/4	7TAA001400R0001	57	710-SPL	7TAA001550R0013	54	72171-1/2 & 3/4-E	7TAA001190R0005	47
54541 1/2 3/4	7TAA001400R0002	57	72 C 1	7TAA001230R0013	48	72171-1234RD	7TAA001590R0021	36
54541-CFB	7TAA001410R0000	34	72 C 13	7TAA001230R0014	49	72171-SVT	7TAA001220R0004	39
54551 1/2 & 3/4	7TAA001400R0003	57	72 C 14	7TAA001230R0015	49	72171CV 1/2 3/4	7TAA001210R0006	47
54551-3/4 & 1	7TAA001410R0001	57	72 C 14 5/8	7TAA001230R0016	49	72171MSX	7TAA001210R0007	47
54551-CFB	7TAA001400R0004	34	72 C 15	7TAA001240R0011	49	72171MSXP	7TAA001220R0007	47
54561-1/2 & 3/4	7TAA001400R0006	57	72 C 16	7TAA001230R0017	49	72C1-VT	7TAA001250R0005	39
54561-3/4 & 1	7TAA001410R0002	57	72 C 17	7TAA001230R0018	49	73-FB-MXN	—	22
54571 1/2 3/4	7TAA001400R0007	57	72 C 18	7TAA001230R0019	49	73-FBC	7TAA001500R0029	22
54571-3/4 & 1	7TAA001400R0008	57	72 C 18 5/8	7TAA001230R0020	49	73-ONCS	7TAA001490R0009	22
54581 1/2 & 3/4	7TAA001410R0003	57	72 C 19	7TAA001240R0012	49	73151 1/2 3/4	7TAA001280R0005	47
54591 1/2 & 3/4	7TAA001410R0004	57	72 C 21	7TAA001230R0021	49	73171 1	7TAA001280R0006	47

Index INDEX - ORDER CODE CLASSIFICATION

Order code classification

Part No.	GID Code	Page No.
73171 1/2 3/4	7TAA001280R0007	47
74-CE	7TAA001500R0030	22
74-FBC	7TAA001980R0291	22
74-ONCS	7TAA001980R0293	22
75-ONCS	7TAA001980R0294	23
7503-SC	7TAA001330R0008	63
802 S	7TBA001500R0031	15
804 S	7TBA001500R0032	17
806 S	7TBA001490R0010	18
806 SW	7TBA001500R0033	16
806 SW 1/4	7TBA001500R0034	16
811 SW-25	7TBA001500R0036	15
820D	7TAA001310R0004	25
82181-1234-RD	7TAA001660R0004	12
A-256	7TAA001500R0037	18
A-258	7TAA001980R0306	16
A12E-25	7TBA001500R0039	15
A16-25	7TBA001500R0040	15
A254-25	7TAA001490R0011	16
A257-25	7TAA001490R0012	16
CBA	7TAA001410R0007	57
CBP	7TAA001400R0016	57
CBP 3/8	7TAA001410R0008	57
CBTW 4	7TAA001540R0005	60
CBTW 6	7TAA001540R0006	60
CBTW 8	7TAA001540R0007	60
CDLE-25	7TBA001490R0014	17
CDOW	7TBA001470R0002	17
CDOWTG-25	7TAA001480R0013	17
CDV-25	7TBA001480R0014	17
CFB-BHL	7TAA001370R0040	35
CTDW	7TAA001540R0008	24
CW 1/2	7TBA001480R0015	17
CW3/4-25	7TBA001480R0016	17
CWLE 3/4	7TBA001500R0051	17
CWLE1/2-25	7TBA001500R0052	17
CWN-25	7TBA001480R0017	16
CWNLE	7TBA001500R0053	16
CWNV-25	7TBA001490R0018	16
CWV 1/2	7TBA001490R0020	17
CWX-25	7TBA001480R0019	18
CWXV-25	7TBA001490R0021	18
CX	7TBA001470R0003	18
CXLE-SSX	7TBA001490R0023	18
CXLESSX	7TBA001490R0023	39
CXP	7TBA001500R0054	18
CXV	7TBA001480R0020	18
CXWLE	7TBA001500R0055	16
CXWOW	7TBA001480R0022	16

Part No.	GID Code	Page No.
CXWOWP	7TBA001500R0056	16
CXWV	7TBA001480R0025	16
CXWVP	7TBA001500R0057	16
CY 1/2	7TBA001470R0004	17
CY 3/4	7TBA001480R0027	17
CYLE 1/2	7TBA001490R0024	17
CYLE 3/4	7TBA001490R0025	17
DGP	7TAA001320R0006	54
GB-10	7TAA038190R0003	56
GB-2	—	56
GB-3	—	56
GB-4	—	56
GB-5	—	56
GB-6	—	56
GB-7	—	56
GB-8	7TAA038190R0009	56
GB9-TS	7TAA001580R0032	56
GEE	7TAA001320R0008	65
GS 1-SC	7TAA001310R0009	65
GSB 12	7TAA001320R0010	65
GSB 14	7TAA001330R0017	65
GSC 12	7TAA001310R0011	65
GSC 14	7TAA001320R0011	65
GSC 14 S	7TAA001320R0012	65
GSC-12-10 1/2	7TAA001320R0013	65
GSC-12-S	7TAA001310R0012	65
GW 125 G	7TBA001530R0008	58
GW 135 G	7TBA001520R0000	58
GW 135 NG-1	7TAA001540R0009	60
GW 225 G	7TBA001540R0010	58
GW 235 G	7TBA001530R0009	58
GW 325 G	7TBA001540R0011	58
GW 335 G	7TBA001530R0010	58
GW 425 G	7TBA001540R0012	58
GW 435 G	7TBA001530R0011	58
GW 525 G	7TBA001540R0013	58
GW-535-G	7TBA001540R0014	58
GW-625-G	7TBA001540R0015	58
GW-635-G	7TBA001540R0016	58
H-54561-1/2 & 3/4	7TAA001360R0041	57
H-54561-3/4	7TAA001370R0043	57
H2BD 3/4 1	7TAA001550R0014	53
H3BD 3/4 1	7TAA001550R0015	53
H4BD 3/4 1	7TAA001550R0016	53
H5BD 3/4 1	7TAA001550R0017	53
H6BD 3/4 1	7TAA001550R0018	53
HBB 18	7TAA001330R0020	57
HBB-24	7TAA001320R0014	57
HBB-30	7TAA001320R0015	57

Part No.	GID Code	Page No.
LCLE-25	7TBA001500R0060	15
LCNOW-25	7TBA001500R0061	15
LCOW-25	7TBA001480R0028	15
LCOWC	7TBA001500R0062	15
LCV-25	7TBA001500R0064	15
LVB	7TAA001330R0021	25
LXLE	7TBA001500R0065	18
LXMOW-25	7TAA001490R0026	18
LXMWOW-25	7TAA001490R0027	15
LXOW-25	7TBA001480R0031	18
LXOWC-25	7TBA001480R0033	18
LXV-25	7TBA001490R0028	18
LXVP	7TBA001980R0376	18
LXWLE-25	7TBA001490R0031	15
LXWOW-25	7TBA001480R0035	15
LXWOWC-25	7TBA001490R0032	15
LXWOWP	7TBA001500R0068	15
LXWSV	7TBA001500R0069	15
LXWV 2G	7TBA001500R0072	16
LXWV-25	7TBA001490R0035	15
MB120ADJ	7TAA001480R0038	13
MB238ADJ	7TAA001480R0041	13
MBP	7TAA001330R0022	59
MBPS	7TAA001330R0023	59
OW Swing Ear	7TAA001320R0018	25
OW SWING EAR	7TAA001320R0018	37
OWC	7TAA001310R0013	25
PGW-25-G	7TBA001330R0025	58
PGW-35-G	7TBA001320R0020	58
PN-3-1	7TAA001330R0026	63
RS 1	7TAA001170R0005	44
RS 10	7TAA001170R0006	44
RS 11	7TAA001160R0010	44
RS 12	7TAA001160R0011	44
RS 13	7TAA001160R0012	44
RS 14	7TAA001170R0007	44
RS 15	7TAA001170R0008	44
RS 2	7TAA001160R0017	44
RS 3	7TAA001170R0009	44
RS 4	7TAA001160R0018	44
RS 5	7TAA001160R0019	44
RS 8	7TAA001160R0020	44
RS 9	7TAA001160R0021	44
RS-16-CC	7TAA001160R0013	44
RS-17-CC	7TAA001160R0014	44
RS-18-CC	7TAA001160R0015	44
RS-19-CC	7TAA001160R0016	44
RSL 11	7TAA001260R0008	49
RSL 12	7TAA001260R0009	49

Index

Order code classification

Part No.	GID Code	Page No.
RSL 13	7TAA001260R0010	49
RSL 14	7TAA001260R0011	49
RSL 15	7TAA001270R0007	49
RSL 16	7TAA001260R0012	49
RSL 17	7TAA001260R0013	49
RSL 18	7TAA001270R0008	49
RSL 19	7TAA001270R0009	49
RSL 2	7TAA001270R0010	49
RSL 4	7TAA001260R0014	49
RSL 5	7TAA001260R0015	49
RSL 8	7TAA001260R0016	49
RSL 9	7TAA001260R0017	49
SB-10	—	56
SB-2	—	56
SB-3	7TAA011980R0016	56
SB-4	7TAA011890R0145	56
SB-5	—	56
SB-6	7TAA011980R0018	56
SB-7	—	56
SB-8	—	56
SB-9	—	56
SBEX	7TBA001310R0015	24
SF-SF-S1/2	—	67
SF-SFA	—	64
SFB-135-11	7TCA001910R0004	11
SFB-147-11	7TCA001910R0005	11
SFB-235-11	7TCA001910R0006	11
SFB-247-11	7TCA001910R0007	11
SFB135	7TCA001910R0000	11
SFB147	7TCA001910R0001	11
SFB235	7TCA001910R0002	11
SFB247	7TCA001910R0003	11
SGP	7TAA001320R0021	54
SH 1/2 & 3/4	7TAA001510R0000	46
SHHF 1/2 3/4	7TAA001510R0001	46
SHHFR 1/2 3/4	7TAA001510R0002	46
SHR 1/2 & 3/4	7TAA001510R0003	46
SS1-TB	7TAA001320R0022	62
SSF-SAB-C1/2 3/4	7TAA015660R0000	68
SSF-SAB-C3/8	7TAA015660R0001	68
SSF-SAB-S1/2	7TAA015660R0002	68
SSF-SAB-S3/4	7TAA015660R0003	68
SSF-SF-C1	7TAA001300R0003	67
SSF-SF-C1/2 3/4	7TAA001300R0004	67
SSF-SF-C3/8	7TAA001300R0005	67
SSF-SF-S1	7TAA001300R0006	67
SSF-SF-S3/4	7TAA001300R0008	67
SSF-SFO	—	64
SSF-SF1/2	7TAA001300R0009	64

Part No.	GID Code	Page No.
SSF-SF1/4	7TAA001980R0434	64
SSF-SF3/4	7TAA001300R0010	64
SSF-SF3/8	7TAA001300R0011	64
SSF-SF5/8	7TAA001980R0435	64
SSF-SFT	#N/A	64
SSF-SK	7TAA001300R0014	64
SSF-SK-C1	7TAA001980R0446	67
SSF-SK-C1/2 3/4	7TAA001300R0015	67
SSF-SK-S1	7TAA001300R0016	67
SSF-SK-S1/2	7TAA001980R0447	67
SSF-SK-S3/4	7TAA001300R0017	67
SSF-SLV	7TAA001300R0018	68
SSF-SMX	7TAA001300R0021	64
SSF-SP1	7TAA015660R0005	68
SSF-SR	7TAA015660R0006	70
SSF-SS1/2 3/4	7TAA015660R0007	69
SSF-SS1/2 3/4D	7TAA015660R0008	69
SSF-ST66	7TBA015660R0009	70
SSQV	7TBA001500R0075	14
SSV	7TBA001500R0078	14
SWB-25	7TBA001480R0043	15
TC121A-FA	7TAA116360R0000	36
TC122A-FA	7TAA116360R0001	36
TC123A-FA	7TAA116360R0002	36
TC721A-FA	7TAA116980R0067	36
TC722A-FA	7TAA116360R0003	36
TC723A-FA	7TAA116360R0004	36
TK121A-FA	7TAA116360R0005	36
TK122A-FA	7TAA116360R0006	36
TK123A-FA	7TAA116360R0007	36
VN1	7TAA040480R0013	68
VN2	7TAA040980R0138	68
VW1	7TAA040980R0139	68
VW2	7TAA040980R0140	68
WBF-1	7TBA126810R0000	68
X1-1/2 & 3/4	7TAA001090R0009	40

Additional information

We reserve the right to make technical changes or modify the contents of this document without prior notice. With regard to purchase orders, the agreed particulars shall prevail. ABB AG does not accept any responsibility whatsoever for potential errors or possible lack of information in this document.

We reserve all rights in this document and in the subject matter and illustrations contained therein. Any reproduction, disclosure to third parties or utilisation of its contents – in whole or in parts – is forbidden without prior written consent of ABB AG.

ABB Middle East

new.abb.com/middle-east

Regional offices

Saudi Arabia

E-Mail: contact.center@sa.abb.com

UAE

Email: contact.center@ae.abb.com

Oman

Email: contact.center@om.abb.com

Qatar

mail: contact.center@qa.abb.com

Kuwait

Email: contact.center@kw.abb.com

<http://new.abb.com/middle-east/contact>

