

Cajas para áreas peligrosas y Cajas de jalado

RAWELT®

SERIE GR Y SERIE GRO



NRTL / C



**Hazardous location conduit outlet boxes and
Explosion proof conduit 90° pulling outlet boxes.**

GR SERIES AND GRO SERIES

5.1

**CAJAS PARA ÁREAS PELIGROSAS. SERIE GR.
CON TAPA. LIBRE DE COBRE.**

Clase I, Div. 1 y 2, grupos B, C, D.
Clase II, Div. 1, grupos E, F, G.
Clase II, Div. 2, grupos F, G.
Clase III
NEMA 3, 4 X, 7 CD, 9 EFG.

- A prueba de explosión.
- A prueba de polvos inflamables.
- A prueba de agua.
- A prueba de ambientes húmedos.
- Material del cuerpo y tapa: Aluminio libre de cobre inyectado a presión (diecast).
- Acabado: Pintura electrostática epóxica/poliéster polimerizada espesor mínimo de 2 mils.
- Pruebas en cámara salina a pintura de acuerdo a ASTM B117.
- Pruebas de adherencia a pintura de acuerdo a ASTM 3359.
- Resistencia a impactos mecánicos en cuerpo de acuerdo a IK09, gracias a su diseño que no cuenta con elementos susceptibles a rompimiento.
- " O " ring de Neopreno a prueba de humedad.
- Tornillo de tierra pasivado incluido.
- Rosca NPT para usarse con tubo conduit RÍGIDO.
- 11 modelos diferentes
- De 1 a 5 salidas para tubo RÍGIDO. Medidas: 1/2", 3/4", 1 1/4", 1", 1 1/2" y 2".

5.1

**HAZARDOUS LOCATION CONDUIT OUTLET BOXES.
GR SERIES. WITH COVER. COPPER FREE ALUMINUM.**

Class I, Div. 1 & 2, Groups B, C, D.
Class II, Div. 1, Groups E, F, G.
Class II, Div. 2, Groups F, G.
Class III
NEMA 3, 4 X, 7 CD, 9 EFG.

- Explosion proof.
- Dust - Ignitionproof.
- Raintight.
- Wet Locations.
- Body and cover: Diecast copper free aluminum.
- " O " ring Neoprene provide raintight fit.
- Finish: Electrostatic powder coating epoxic/polyester. Minimum thickness 2 mils.
- Saline chamber test to paint according to ASTM B117.
- Paint adhesion test according ASTM 3359.
- Resistance to mechanical impacts according IK09 body, thanks to its design that does not have elements susceptible to breakage.
- Green ground screw included.
- NPT threaded for use with RIGID conduit.

5.3

**CAJAS DE JALADO A 90° A PRUEBA DE EXPLOSIÓN.
SERIE GRO. CON TAPA. LIBRE DE COBRE.**

Caja GRO diseñada para jalado a 90 ° de cables eléctricos de grueso calibre sin dañar el aislamiento ya que la caja y tapa cuentan con gran capacidad interior que puede alojar la curvatura del cable.

Clase I, Div. 1 y 2, grupos B, C, D.
Clase II, Div. 1, grupos E, F, G.
Clase II, Div. 2, grupos F, G.
Clase III
Clase I Zona 2 / Grupos II B, II A
NEMA 3, 4 X, 7 CD, 9 EFG.

- A prueba de explosión.
- A prueba de polvos inflamables.
- A prueba de agua.
- A prueba de ambientes húmedos.
- Material del cuerpo y tapa: Aluminio libre de cobre inyectado a presión (diecast).
- Acabado: Pintura electrostática epóxica/poliéster polimerizada.
- Rosca NPT para usarse con tubo conduit RÍGIDO.
- Tapa sujeta con gruesos tornillos hexagonales de acero inoxidable al cuerpo.

5.3

**EXPLOSION PROOF CONDUIT 90° PULLING OUTLET BOXES.
GRO SERIES. WITH COVER. COPPER FREE ALUMINUM.**

GRO 90 ° pulling outlet box designed to pull heavy conductors with no damage to the installation, for the large chamber created by the box and cover.

Class I, Div. 1 & 2, Groups B, C, D.
Class II, Div. 1, Groups E, F, G.
Class II, Div. 2, Groups F, G.
Class III
Class I Zone 2 / Groups II B, II A
NEMA 3, 4 X, 7 CD, 9 EFG.

- Explosion proof.
- Dust - Ignitionproof.
- Raintight.
- Wet Locations.
- Body and cover: Diecast copper free aluminum.
- Saline chamber test according to ASTM B117.
- Paint adhesion test according to ASTM 3359.
- Finish: Electrostatic powder epoxic/polyester coating.
- NTP threaded for use with RIGID conduit.
- Cover bolted to the box with heavy hexagonal bolts.

Cumple con /
Compliances:
UL 886
UL 1203
CSA C22.2 No. 30



RAWELT, S.A. de C.V.

Torreón, Coah., México
Tel: 871 747 47 84 / Ventas: 800 999 20 18
torreon@rawelt.com.mx



www.rawelt.com.mx



Serie GR y GRO Sección 5.1 y 5.3 | RW10

22-02

**5.1 - CAJAS PARA AREAS PELIGROSAS. SERIE GR.
CON TAPA. LIBRE DE COBRE.**

**5.1 - HAZARDOUS LOCATION CONDUIT OUTLET BOXES. GR SERIES.
WITH COVER. COPPER FREE ALUMINUM.**

Hoja: 1 / 3
Page:

FICHA TECNICA / TECHNICAL DATA

007 - RW - 208



- * Clase I, Div. 1 y 2, grupos B, C, D.
- Clase II, Div. 1, grupos E, F, G.
- Clase II, Div. 2, grupos F, G.
- Clase III
- NEMA 3, 4 X, 7 CD, 9 EFG.

- A prueba de explosión.
- A prueba de polvos inflamables.
- A prueba de agua.
- A prueba de ambientes humedos.

- Material del cuerpo y tapa: Aluminio libre de cobre inyectado a presión (diecast).
- Acabado: Pintura electrostática epóxica/poliéster polimerizada espesor mínimo de 2 mils
- Pruebas en cámara salina a pintura de acuerdo a ASTM B117
- Pruebas de adherencia a pintura de acuerdo a ASTM 3359
- Resistencia a impactos mecánicos en cuerpo de acuerdo a IK09, gracias a su diseño que no cuenta con elementos susceptibles a rompimiento.
- "O" ring de Neopreno a prueba de humedad.
- Tornillo de tierra pasivado incluido.
- Acabados: Pintura electrostática epoxica/poliéster polimerizado.
- Rosca NPT para usarse con tubo conduit RIGIDO.
- Fabricación en base a: UL 886, UL 1203.

CAN/CSA - C22.2 No. 30

USAR No. DE CODIGO PARA HACER PEDIDOS / TO ORDER USE CODE NUMBER

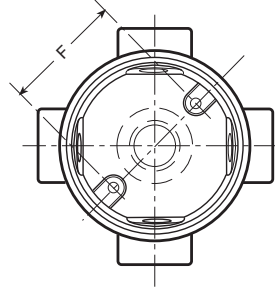
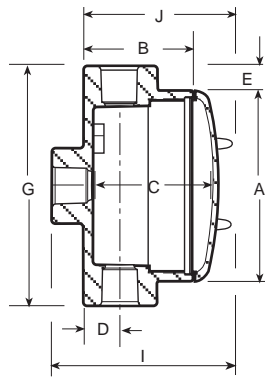

Para dimensiones:
Ver Ficha Tecnica 007 - RW - 202

For dimensions:
See Technical Data 007 - RW - 202

- * Class I, Div. 1 & 2, Groups B, C, D.
- Class II, Div. 1, Groups E, F, G.
- Class II, Div. 2, Groups F, G.
- Class III
- NEMA 3, 4 X, 7 CD, 9 EFG.

Explosionproof
Dust - Ignitionproof
Raintight
Wet Locations

Material:

- Body and cover: Diecast copper free aluminum.
- "O" ring Neoprene provide raintight fit.
- Finish: Electrostatic powder coating epoxic/polyester. Minimum thickness 2 mils.
- Saline chamber test to paint according to ASTM B117.
- Paint adhesion test according ASTM 3359.
- Resistance to mechanical impacts according IK09 body, thanks to its design that does not have elements susceptible to breakage.
- Green ground screw included.
- Finish: Electrostatic powder epoxy/poliéster coating.
- NPT threaded for use with RIGID conduit.
- Manufactured in compliance with: UL 886, UL 1203.

CAN/CSA - C22.2 No. 30

Figura Figure	Modelo Model	Salidas Hubs	Catalogo Catalog	Codigo Code	Medida nominal Hub size		Abertura Cover opening dia.		Volumen Volume		Peso x 100 pzas. Weight x 100 pcs.		Pqt. Unit. Pcs.	Std. Pkg. Pzas.
					mm	inch.	mm	inch.	cm ³	cu. in	kg	Lb		
	GRE	1	GRE-0447	04.04.1295	12.7	1/2	83	3.27	246	15	47	104		30
			GRE-0448	04.04.1296	19.0	3/4	83	3.27	246	15	47	104		
			GRE-0582	04.04.2341	25.4	1	127	3.27	289.9	17.3	53	117		
			GRE-0587	04.04.2342	31.8	1 1/4	127	5.0	1203.0	73.3	164	362		
			GRE-0598	04.04.2343	38.1	1 1/2	127	5.0	1203.0	73.3	162	357		
			GRE-0603	04.04.2344	50.8	2	127	5.0	1303.5	79.3	177	390		
	GRC	2	GRC-0443	04.04.1291	12.7	1/2	83	3.27	246	15	50	110		30
			GRC-0444	04.04.1292	19.0	3/4	83	3.27	246	15	47	104		
			GRC-0556	04.04.2345	25.4	1	127	3.27	289.9	17.3	54	119		
			GRC-0589	04.04.2346	31.8	1 1/4	127	5.0	1191.5	73.3	168	370		
			GRC-0561	04.04.2347	38.1	1 1/2	127	5.0	1191.5	73.3	164	362		
			GRC-0580	04.04.2348	50.8	2	127	5.0	1305.9	79.3	183	403		
	GRL	2	GRL-0439	04.04.1287	12.7	1/2	83	3.27	246	15	49	108		30
			GRL-0440	04.04.1288	19.0	3/4	83	3.27	246	15	47	104		
			GRL-0546	04.04.2349	25.4	1	127	3.27	290.0	17.3	54	119		
			GRL-0591	04.04.2350	31.8	1 1/4	127	5.0	1198.3	73.0	168	370		
			GRL-0558	04.04.2351	38.1	1 1/2	127	5.0	1198.3	73.0	164	362		
			GRL-0576	04.04.2352	50.8	2	127	5.0	1306.5	79.3	183	403		

Especificaciones sujetas a cambio sin previo aviso.
Specifications are subject to change without notice.

* Group B authorized only by
* Grupo B autorizado solo por

RAWELT, S.A. de C.V.

RAWELT® INYECTADOS
Una División del Grupo **REVUELTA**

**5.1 - CAJAS PARA AREAS PELIGROSAS. SERIE GR.
CON TAPA. LIBRE DE COBRE.**



**5.1 - HAZARDOUS LOCATION CONDUIT OUTLET BOXES. GR SERIES.
WITH COVER. COPPER FREE ALUMINUM.**

Hoja: 2 / 3
Page:

FICHA TECNICA / TECHNICAL DATA

007-RW-208

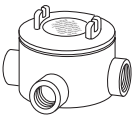
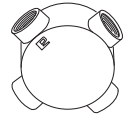
USAR No. DE CODIGO PARA HACER PEDIDOS / TO ORDER USE CODE NUMBER

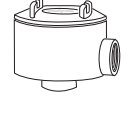
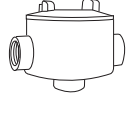
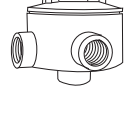
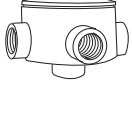
Figura Figure	Modelo Model	Salidas Hubs	Catalogo Catalog	Codigo Code	Medida nominal Hub size		Abertura Cover opening dia.		Volumen Volume		Peso x 100 pzas. Weight x 100 pcs.		Pqt. Unit. Pcs.	Std. Pkg. Pzas. Pcs.
					mm	inch.	mm	inch.	cm ³	cu. in	kg	Lb		
						GRT	3	GRT-0441	04.04.1289	12.7	1/2	83		
GRT-0442	04.04.1290	19.0	3/4	83	3.27			246	15	48	106	27		
GRT-0547	04.04.2353	25.4	1	83	3.27			295.5	17.3	55	121	23		
GRT-0593	04.04.2354	31.8	1 1/4	127	5.0			1158.5	70.3	178	392	6		
GRT-0559	04.04.2355	38.1	1 1/2	127	5.0			1158.5	70.3	173	381	6		
GRT-0578	04.04.2356	50.8	2	127	5.0			1312.0	79.3	188	414	4		
	GRX	4	GRX-0449	04.04.1297	12.7	1/2	83	3.27	246	15	53	117	27	
GRX-0450			04.04.1298	19.	3/4	83	3.27	246	15	49	108	27		
GRX-0585			04.04.2357	25.4	1	83	3.27	290.0	17.3	56	123	23		
GRX-0595			04.04.2358	31.8	1 1/4	127	5.0	1154.5	70.3	186	410	4		
GRX-0601			04.04.2359	38.1	1 1/2	127	5.0	1154.5	70.3	177	390	4		
GRX-0606			04.04.2360	50.8	2	127	5.0	1305.8	79.3	194	428	4		
	GRB	2	GRB-0445	04.04.1293	12.7	1/2	83	3.27	246	15	50	110	27	
GRB-0446			04.04.1294	19.0	3/4	83	3.27	246	15	48	106	27		
GRB-0584			04.04.2361	25.4	1	83	3.27	292.0	17.3	54	119	18		
GRB-0597			04.04.2362	31.8	1 1/4	127	5.0	1193.0	72.3	168	370	4		
GRB-0600			04.04.2363	38.1	1 1/2	127	5.0	1193.0	72.3	164	362	4		
GRB-0605			04.04.2364	50.8	2	127	5.0	1316.5	80.0	183	403	4		
	GREZ	2	GREZ-0466	04.04.1305	12.7	1/2	83	3.27	246	15	51	112	27	
GREZ-0467			04.04.1306	19.0	3/4	83	3.27	246	15	49	108	27		
GREZ-0583			04.04.2365	25.4	1	83	3.27	289.9	17.3	54	119	18		
GREZ-0588			04.04.2366	31.8	1 1/4	127	5.0	1203.0	73.3	168	370	4		
GREZ-0599			04.04.2367	38.1	1 1/2	127	5.0	1203.0	73.3	163	359	4		
GREZ-0604			04.04.2368	50.8	2	127	5.0	1311.5	79.8	183	403	4		
	GRCZ	3	GRCZ-0464	04.04.1303	12.7	1/2	83	3.27	246	15	52	115	27	
GRCZ-0465			04.04.1304	19.0	3/4	83	3.27	246	15	50	110	27		
GRCZ-0557			04.04.2369	25.4	1	83	3.27	289.6	17.3	55	121	18		
GRCZ-0590			04.04.2370	31.8	1 1/4	127	5.0	1191.5	73.3	178	392	4		
GRCZ-0562			04.04.2371	38.1	1 1/2	127	5.0	1191.5	73.3	173	381	4		
GRCZ-0581			04.04.2372	50.8	2	127	5.0	1305.9	79.3	188	414	4		
	GRLZ	3	GRLZ-0460	04.04.1299	12.7	1/2	83	3.27	246	15	52	115	27	
GRLZ-0461			04.04.1300	19.0	3/4	83	3.27	246	15	49	108	27		
GRLZ-0573			04.04.2373	25.4	1	83	3.27	290.0	17.3	55	121	18		
GRLZ-0592			04.04.2374	31.8	1 1/4	127	5.0	1198.3	73.3	178	392	4		
GRLZ-0574			04.04.2375	38.1	1 1/2	127	5.0	1198.3	73.3	173	381	4		
GRLZ-0577			04.04.2376	50.8	2	127	5.0	1306.5	79.3	188	414	4		
	GRTZ	4	GRTZ-0462	04.04.1301	12.7	1/2	83	3.27	246	15	53	117	24	
GRTZ-0463			04.04.1302	19.0	3/4	83	3.27	246	15	51	112	24		
GRTZ-0555			04.04.2377	25.4	1	83	3.27	295.5	17.8	56	123	18		
GRTZ-0594			04.04.2378	31.8	1 1/4	127	5.0	1158.5	70.3	186	410	4		
GRTZ-0560			04.04.2379	38.1	1 1/2	127	5.0	1158.5	70.3	177	390	4		
GRTZ-0579			04.04.2380	50.8	2	127	5.0	1312.0	79.8	194	428	4		

RAWELT, S.A. de C.V.

RAWELT® INYECTADOS

Una División del Grupo REVUELTA

5.1 - CAJAS PARA AREAS PELIGROSAS. SERIE GR.

CON TAPA. LIBRE DE COBRE.

5.1 - HAZARDOUS LOCATION CONDUIT OUTLET BOXES. GR SERIES.



WITH COVER. COPPER FREE ALUMINUM.

Hoja: 3 / 3
Page:

FICHA TECNICA / TECHNICAL DATA

007-RW-208

USAR No. DE CODIGO PARA HACER PEDIDOS / TO ORDER USE CODE NUMBER

Figura Figure	Modelo Model	Salidas Hubs	Catalogo Catalog	Codigo Code	Medida nominal Hub size		Abertura Cover opening dia.		Volumen Volume		Peso x 100 pzas. Weight x 100 pcs.		Pqt. Unit. Pzas. Pcs.	Std. Pkg. Pzas. Pcs.
					mm	inch.	mm	inch.	cm ³	cu. in	kg	Lb		
	GRXZ	5	GRXZ-0468	04.04.1307	12.7	1/2	83	3.27	246	15	57	126	22	
			GRXZ-0469	04.04.1308	19.0	3/4	83	3.27	246	15	53	117	22	
			GRXZ-0586	04.04.2381	25.4	1	83	3.27	290.0	17.3	57	126	18	
			GRXZ-0596	04.04.2382	31.8	1 1/4	127	5.0	1183.9	72.0	194	428	4	
			GRXZ-0602	04.04.2383	38.1	1 1/2	127	5.0	1183.9	72.0	186	410	4	
			GRXZ-0607	04.04.2384	50.8	2	127	5.0	1305.8	79.3	202	445	3	
Figura Figure	Catalogo Catalog	Codigo Code	Diametro interior Inside diameter		Sección Section									
			mm	inch	mm	inch								
	EA-0545	04.05.0545	75.87	2.987	2.62	0.103							10	
	EA-2325	04.05.2325	129.77	5.109	3.53	0.139							10	
	GR-0451	04.15.0451	Descripción / Description											
			Tapa GR 12.7 a 25.4 (1/2 a 1). M 85 x 2									81		
	GR-0575	04.15.0575	Tapa GR 31.8 a 50.8 (1 1/4 a 2). M 136.7 x 2.5									32		

Certificaciones / Compliances:



Expediente/File No. LR 105795-2



Expediente/File No. E181329

Especificaciones sujetas a cambio sin previo aviso.

Specifications are subject to change without notice.

RAWELT, S.A. de C.V.

RAWELT® INYECTADOS
Una División del Grupo **REVELTA**

**5.1 - CAJAS PARA AREAS PELIGROSAS. SERIE GR.
CON TAPA. LIBRE DE COBRE.**

**5.1 - HAZARDOUS LOCATIONS CONDUIT OUTLET BOXES. GR SERIES.
WITH COVER. COPPER FREE ALUMINUM.**

Hoja: 1 / 1
Page:

FICHA TECNICA / TECHNICAL DATA

007-RW-202

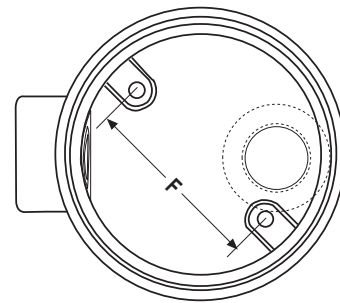
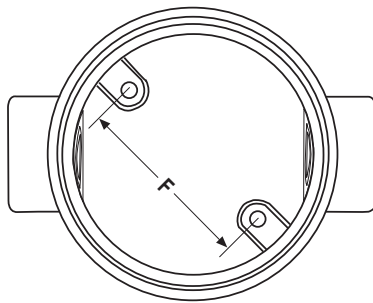
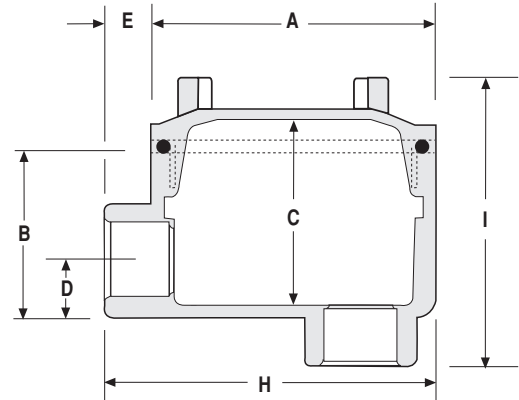
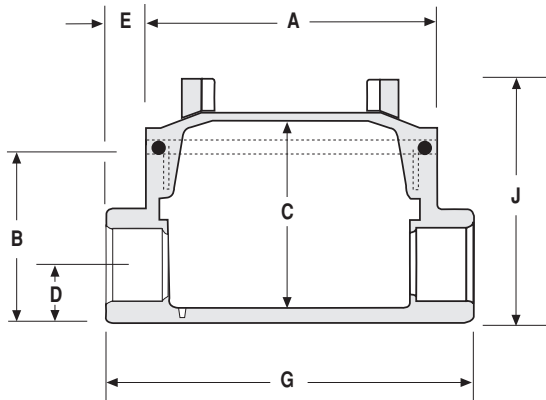

Salidas para tubo Hub size		Dimensiones / Dimensions																			
		A		B		C		D		E		F		G		H		I		J	
mm.	Inch	mm.	Inch	mm.	Inch	mm.	Inch	mm.	Inch	mm.	Inch	mm.	Inch	mm.	Inch	mm.	Inch	mm.	Inch	mm.	Inch
12.7	1/2	93	3.66	53	2.09	56	2.20	18	0.71	13	0.51	58	2.28	119	4.69	105	4.13	92	3.62	77	3.03
19.0	3/4	93	3.66	53	2.09	56	2.20	18	0.71	13	0.51	58	2.28	119	4.69	105	4.13	92	3.62	77	3.03
25.4	1	93	3.66	63	2.48	66	2.60	24	0.95	17	0.67	58	2.28	121	4.76	108	4.25	102	4.02	86	3.39
31.8	1 1/4	147	5.79	97	3.82	98	3.86	31	1.22	20	0.79	101	3.98	187	7.36	167	6.57	147	5.79	127	5.0
38.1	1 1/2	147	5.79	97	3.82	98	3.86	31	1.22	20	0.79	101	3.98	187	7.36	167	6.57	147	5.79	127	5.0
50.8	2	147	5.79	108	4.25	108	4.25	38	1.50	20	0.79	101	3.98	187	7.36	167	6.57	147	5.79	127	5.0

RAWELT, S.A. de C.V.

RAWELT INYECTADOS

Una División del Grupo REVUELTA

**5.1 - CAJAS PARA AREAS PELIGROSAS. SERIE GR.
CON TAPA. LIBRE DE COBRE.**

**5.1 - HAZARDOUS LOCATION CONDUIT OUTLET BOXES. GR SERIES.
WITH COVER. COPPER FREE ALUMINUM.**

Hoja: 1 / 3
Page:

FICHA TECNICA / TECHNICAL DATA

007-RW-260

**TABLA DE EQUIVALENCIAS.
CROSS REFERENCE GUIDE.**

1 ENTRADA / 1 HUB									
	Medida Nominal Size	RAWELT ¹		C.H.D. ²	CROUSE HINDS ²	RED-DOT ²	KILLARK ²	APPLETON ³	OZ GEDNEY ⁴
		Código Code	Catalogo Catalog	Catalogo Catalog	Catalogo Catalog	Catalogo Catalog	Catalogo Catalog	Catalogo Catalog	Catalogo Catalog
	1/2 "	04.04.1295	GRE-0447	GUA 16 MEX.	GUA 16 SA U.S.A.	GAE-1	GRR-1	GRE50	GUAE-50
	3/4 "	04.04.1296	GRE-0448	GUA 26 MEX.	GUA 26 SA U.S.A.	GAE-2	GRR-2	GRE75	GUAE-75
	1 "	04.04.2341	GRE-0582	GUA 36 MEX.	GUA 36 SA U.S.A.	GAE-3	GRR-3	GRE100	
	1 1/4 "	04.04.2342	GRE-0587	GUA 49 MEX.				GRE125	
	1 1/2 "	04.04.2343	GRE-0598	GUA 59 MEX.	GUA 59 SA U.S.A.			GRE150	
	2 "	04.04.2344	GRE-0603	GUA 69 MEX.					

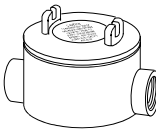
2 ENTRADAS / 2 HUBS									
	Medida Nominal Size	RAWELT ¹		C.H.D. ²	CROUSE HINDS ²	RED-DOT ²	KILLARK ²	APPLETON ³	OZ GEDNEY ⁴
		Código Code	Catalogo Catalog	Catalogo Catalog	Catalogo Catalog	Catalogo Catalog	Catalogo Catalog	Catalogo Catalog	Catalogo Catalog
	1/2 "	04.04.1291	GRC-0443	GUAC 16 MEX.	GUAC 16 SA U.S.A.	GAC-1	GRR-1	GRC50	GUAC-50
	3/4 "	04.04.1292	GRC-0444	GUAC 26 MEX.	GUAC 26 SA U.S.A.	GAC-2	GRR-2	GRC75	GUAC-75
	1 "	04.04.2345	GRC-0556	GUAC 36 MEX.	GUAC 36 SA U.S.A.	GAC-3	GRR-3	GRC100	GUAC-100
	1 1/4 "	04.04.2346	GRC-0589	GUAC 49 MEX.	GUAC 49 SA U.S.A.	GAC-4		GRC125	GUAC-125
	1 1/2 "	04.04.2347	GRC-0561	GUAC 59 MEX.	GUAC 59 SA U.S.A.	GAC-5		GRC150	GUAC-150
	2 "	04.04.2348	GRC-0580	GUAC 69 MEX.	GUAC 69 SA U.S.A.	GAC-6		GRC200	GUAC-200

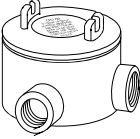
2 ENTRADAS / 2 HUBS									
	Medida Nominal Size	RAWELT ¹		C.H.D. ²	CROUSE HINDS ²	RED-DOT ²	KILLARK ²	APPLETON ³	OZ GEDNEY ⁴
		Código Code	Catalogo Catalog	Catalogo Catalog	Catalogo Catalog	Catalogo Catalog	Catalogo Catalog	Catalogo Catalog	Catalogo Catalog
	1/2 "	04.04.1287	GRL-0439	GUAL 16 MEX.	GUAL 16 SA U.S.A.	GAL-1	GRR-1	GRL50	GUAL-50
	3/4 "	04.04.1288	GRL-0440	GUAL 26 MEX.	GUAL 26 SA U.S.A.	GAL-2	GRR-2	GRL75	GUAL-75
	1 "	04.04.2349	GRL-0546	GUAL 36 MEX.	GUAL 36 SA U.S.A.	GAL-3	GRR-3	GRL100	GUAL-100
	1 1/4 "	04.04.2350	GRL-0591	GUAL 49 MEX.	GUAL 49 SA U.S.A.	GAL-4		GRL125	GUAL-125
	1 1/2 "	04.04.2351	GRL-0558	GUAL 59 MEX.	GUAL 59 SA U.S.A.	GAL-5		GRL150	GUAL-150
	2 "	04.04.2352	GRL-0576	GUAL 69 MEX.	GUAL 69 SA U.S.A.	GAL-6		GRL200	GUAL-200

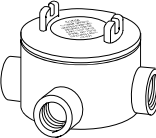
3 ENTRADAS / 3 HUBS									
	Medida Nominal Size	RAWELT ¹		C.H.D. ²	CROUSE HINDS ²	RED-DOT ²	KILLARK ²	APPLETON ³	OZ GEDNEY ⁴
		Código Code	Catalogo Catalog	Catalogo Catalog	Catalogo Catalog	Catalogo Catalog	Catalogo Catalog	Catalogo Catalog	Catalogo Catalog
	1/2 "	04.04.1289	GRT-0441	GUAT 16 MEX.	GUAT 16 SA U.S.A.	GAT-1	GRR-1	GRT50	GUAT-50
	3/4 "	04.04.1290	GRT-0442	GUAT 26 MEX.	GUAT 26 SA U.S.A.	GAT-2	GRR-2	GRT75	GUAT-75
	1 "	04.04.2353	GRT-0547	GUAT 36 MEX.	GUAT 36 SA U.S.A.	GAT-3	GRR-3	GRT100	GUAT-100
	1 1/4 "	04.04.2354	GRT-0593	GUAT 49 MEX.	GUAT 49 SA U.S.A.	GAT-4		GRT125	GUAT-125
	1 1/2 "	04.04.2355	GRT-0559	GUAT 59 MEX.	GUAT 59 SA U.S.A.	GAT-5		GRT150	GUAT-150
	2 "	04.04.2356	GRT-0578	GUAT 69 MEX.	GUAT 69 SA U.S.A.	GAT-6		GRT200	GUAT-200

RAWELT, S.A. de C.V.



5.1 - CAJAS PARA AREAS PELIGROSAS. SERIE GR.
CON TAPA. LIBRE DE COBRE.

5.1 - HAZARDOUS LOCATION CONDUIT OUTLET BOXES. GR SERIES.
WITH COVER. COPPER FREE ALUMINUM.

Hoja: 2 / 3
Page:

FICHA TECNICA / TECHNICAL DATA

007-RW-260

**TABLA DE EQUIVALENCIAS.
CROSS REFERENCE GUIDE.**

4 ENTRADAS / 4 HUBS								
Medida Nominal Size	RAWELT ¹		C.H.D. ²	CROUSE HINDS ²	RED-DOT ²	KILLARK ²	APPLETON ³	OZ GEDNEY ⁴
	Código Code	Catalogo Catalog	Catalogo Catalog	Catalogo Catalog	Catalogo Catalog	Catalogo Catalog	Catalogo Catalog	Catalogo Catalog
1/2 "	04.04.1297	GRX-0449	GUAX 16 MEX.	GUAX 16 SA U.S.A.	GAX-1	GRR-1	GRX50	GUAX-50
3/4 "	04.04.1298	GRX-0450	GUAX 26 MEX.	GUAX 26 SA U.S.A.	GAX-2	GRR-2	GRX75	GUAX-75
1 "	04.04.2357	GRX-0585	GUAX 36 MEX.	GUAX 36 SA U.S.A.	GAX-3	GRR-3	GRX100	
1 1/4 "	04.04.2358	GRX-0595	GUAX 49 MEX.	GUAX 49 SA U.S.A.	GAX-4		GRX125	
1 1/2 "	04.04.2359	GRX-0601	GUAX 59 MEX.	GUAX 59 SA U.S.A.	GAX-5		GRX150	
2 "	04.04.2360	GRX-0606	GUAX 69 MEX.	GUAX 69 SA U.S.A.	GAX-6		GRX200	

2 ENTRADAS / 2 HUBS								
Medida Nominal Size	RAWELT ¹		C.H.D. ²	CROUSE HINDS ²	RED-DOT ²	KILLARK ²	APPLETON ³	OZ GEDNEY ⁴
	Código Code	Catalogo Catalog	Catalogo Catalog	Catalogo Catalog	Catalogo Catalog	Catalogo Catalog	Catalogo Catalog	Catalogo Catalog
1/2 "	04.04.1293	GRB-0445	GUAB 16 MEX.	GUAB 16 SA U.S.A.			GRLB50	GUALB - 50
3/4 "	04.04.1294	GRB-0446	GUAB 26 MEX.	GUAB 26 SA U.S.A.			GRLB75	GUALB - 75
1 "	04.04.2361	GRB-0584	GUAB 36 MEX.	GUAB 36 SA U.S.A.			GRLB100	
1 1/4 "	04.04.2362	GRB-0597	GUAB 49 MEX.				GRLB125	
1 1/2 "	04.04.2363	GRB-0600	GUAB 59 MEX.	GUAB 59 SA U.S.A.			GRLB150	
2 "	04.04.2364	GRB-0605	GUAB 69 MEX.	GUAB 69 SA U.S.A.			GRLB200	

2 ENTRADAS / 2 HUBS								
Medida Nominal Size	RAWELT ¹		C.H.D. ²	CROUSE HINDS ²	RED-DOT ²	KILLARK ²	APPLETON ³	OZ GEDNEY ⁴
	Código Code	Catalogo Catalog	Catalogo Catalog	Catalogo Catalog	Catalogo Catalog	Catalogo Catalog	Catalogo Catalog	Catalogo Catalog
1/2 "	04.04.1305	GREZ-0466				GRR - 1		
3/4 "	04.04.1306	GREZ-0467				GRR - 2		
1 "	04.04.2365	GREZ-0583				GRR - 3		
1 1/4 "	04.04.2366	GREZ-0588						
1 1/2 "	04.04.2367	GREZ-0599						
2 "	04.04.2368	GREZ-0604						

3 ENTRADAS / 3 HUBS								
Medida Nominal Size	RAWELT ¹		C.H.D. ²	CROUSE HINDS ²	RED-DOT ²	KILLARK ²	APPLETON ³	OZ GEDNEY ⁴
	Código Code	Catalogo Catalog	Catalogo Catalog	Catalogo Catalog	Catalogo Catalog	Catalogo Catalog	Catalogo Catalog	Catalogo Catalog
1/2 "	04.04.1303	GRCZ-0464		GUAD 16 SA U.S.A.		GRR - 1	GRCA50	
3/4 "	04.04.1304	GRCZ-0465		GUAD 26 SA U.S.A.		GRR - 2	GRCA75	
1 "	04.04.2369	GRCZ-0557		GUAD 36 SA U.S.A.		GRR - 3		
1 1/4 "	04.04.2370	GRCZ-0590		GUAD 49 SA U.S.A.				
1 1/2 "	04.04.2371	GRCZ-0562						
2 "	04.04.2372	GRCZ-0581						

RAWELT, S.A. de C.V.

RAWELT INYECTADOS
Una División del Grupo **REVUELTA**

**5.1 - CAJAS PARA AREAS PELIGROSAS. SERIE GR.
CON TAPA. LIBRE DE COBRE.**
**5.1 - HAZARDOUS LOCATION CONDUIT OUTLET BOXES. GR SERIES.
WITH COVER. COPPER FREE ALUMINUM.**

Hoja: 3 / 3
Page:

FICHA TECNICA / TECHNICAL DATA

007-RW-260

**TABLA DE EQUIVALENCIAS.
CROSS REFERENCE GUIDE.**

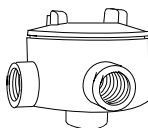
3 ENTRADAS / 3 HUBS								
 Medida Nominal Size	RAWELT ¹		C.H.D. ²	CROUSE HINDS ²	RED-DOT ²	KILLARK ²	APPLETON ³	OZ GEDNEY ⁴
	Código Code	Catalogo Catalog	Catalogo Catalog	Catalogo Catalog	Catalogo Catalog	Catalogo Catalog	Catalogo Catalog	Catalogo Catalog
1/2 "	04.04.1299	GRLZ-0460		GUAM 16 SA U.S.A.		GRR-1	GRLA50	
3/4 "	04.04.1300	GRLZ-0461		GUAM 26 SA U.S.A.		GRR-2	GRLA75	
1 "	04.04.2373	GRLZ-0573		GUAM 36 SA U.S.A.		GRR-3		
1 1/4 "	04.04.2374	GRLZ-0592						
1 1/2 "	04.04.2375	GRLZ-0574						
2 "	04.04.2376	GRLZ-0577		GUAM 69 SA U.S.A.				

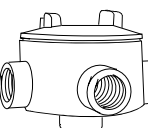
4 ENTRADAS / 4 HUBS								
 Medida Nominal Size	RAWELT ¹		C.H.D. ²	CROUSE HINDS ²	RED-DOT ²	KILLARK ²	APPLETON ³	OZ GEDNEY ⁴
	Código Code	Catalogo Catalog	Catalogo Catalog	Catalogo Catalog	Catalogo Catalog	Catalogo Catalog	Catalogo Catalog	Catalogo Catalog
1/2 "	04.04.1301	GRTZ-0462		GUAW 16 U.S.A.		GRR-1	GRTA50	
3/4 "	04.04.1302	GRTZ-0463		GUAW 26 U.S.A.		GRR-2	GRTA75	
1 "	04.04.2377	GRTZ-0555				GRR-3		
1 1/4 "	04.04.2378	GRTZ-0594						
1 1/2 "	04.04.2379	GRTZ-0560						
2 "	04.04.2380	GRTZ-0579						

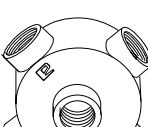
5 ENTRADAS / 5 HUBS								
 Medida Nominal Size	RAWELT ¹		C.H.D. ²	CROUSE HINDS ²	RED-DOT ²	KILLARK ²	APPLETON ³	OZ GEDNEY ⁴
	Código Code	Catalogo Catalog	Catalogo Catalog	Catalogo Catalog	Catalogo Catalog	Catalogo Catalog	Catalogo Catalog	Catalogo Catalog
1/2 "	04.04.1307	GRXZ - 0468				GRR-1		
3/4 "	04.04.1308	GRXZ - 0469				GRR-2		
1 "	04.04.2381	GRXZ - 0586				GRR-3		
1 1/4 "	04.04.2382	GRXZ - 0596						
1 1/2 "	04.04.2383	GRXZ - 0602						
2 "	04.04.2384	GRXZ - 0607						

- 1 Aluminio inyectado a presión libre de cobre
- 2 Aluminio vaciado libre de cobre
- 3 Cuerpo hierro maleable / tapa aluminio
- 4 Hierro maleable

- 1 Copper free diecast aluminum
- 2 Cast copper free aluminum
- 3 Maleable iron body / aluminum cover
- 4 Maleable iron

Rawelt, S.A. de C.V. no asume ninguna responsabilidad por omisiones, errores, diferencias, en el diseño o función entre los productos arriba mencionados.

Rawelt, S.A. de C.V. assumes no liability for omission, errors, differences between bodies above mentioned or change in design or function.

RAWELT, S.A. de C.V.



Una División del Grupo REVUELTA

Cotización/Quotation Plazo de embarque* / Shipment exw* :

Pedido No./Purchase order :

Our ref.:

Fecha/Date: Vendedor/Salesman: No.

Facturar a/Invoice to: RFC:

Ordenado por/Ordered by: Tel. () Fax ()

Dirección/Address:











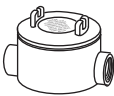

C.P./Zip: Lugar/City/Country:

Consignar a/Ship to:

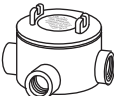
Embarcar: Camión x Cobrar Pagado Paquete

Cond. de Pago/Terms:

Cond. de Venta/Sale conditions: L.P.:

5.1 - SERIE GR. CAJAS PARA AREAS PELIGROSAS / HAZARDOUS LOCATION CONDUIT OULET BOXES.												
Figura Figure	Código Code	Medida Nominal Hub size		Std. Pkg. Pzas. Pcs.	Cantidad Qty.	Figura Figure	Código Code	Medida Nominal Hub size		Pqt. Unit. Pzas. Pcs.	Std. Pkg. Pzas. Pcs.	Cantidad Qty.
		mm	inch					mm	inch			
 GRE	04.04.1295	12.7	1/2	30		 GREZ	04.04.1305	12.7	1/2		27	
	04.04.1296	19.0	3/4	30			04.04.1306	19.0	3/4		27	
	04.04.2341	25.4	1	27			04.04.2365	25.4	1		18	
	04.04.2342	32.0	1 1/4	6			04.04.2366	32.0	1 1/4		4	
	04.04.2343	38.0	1 1/2	6			04.04.2367	38.0	1 1/2		4	
	04.04.2344	50.8	2	4			04.04.2368	50.8	2		4	
 GRC	04.04.1291	12.7	1/2	30		 GRCZ	04.04.1303	12.7	1/2		27	
	04.04.1292	19.0	3/4	30			04.04.1304	19.0	3/4		27	
	04.04.2345	25.4	1	27			04.04.2369	25.4	1		18	
	04.04.2346	32.0	1 1/4	6			04.04.2370	32.0	1 1/4		4	
	04.04.2347	38.0	1 1/2	6			04.04.2371	38.0	1 1/2		4	
	04.04.2348	50.8	2	4			04.04.2372	50.8	2		4	
 GRL	04.04.1287	12.7	1/2	30		 GRLZ	04.04.1299	12.7	1/2		27	
	04.04.1288	19.0	3/4	30			04.04.1300	19.0	3/4		27	
	04.04.2349	25.4	1	27			04.04.2373	25.4	1		18	
	04.04.2350	32.0	1 1/4	6			04.04.2374	32.0	1 1/4		4	
	04.04.2351	38.0	1 1/2	6			04.04.2375	38.0	1 1/2		4	
	04.04.2352	50.8	2	4			04.04.2376	50.8	2		4	
 GRT	04.04.1289	12.7	1/2	27		 GRTZ	04.04.1301	12.7	1/2		24	
	04.04.1290	19.0	3/4	27			04.04.1302	19.0	3/4		24	
	04.04.2353	25.4	1	23			04.04.2377	25.4	1		18	
	04.04.2354	32.0	1 1/4	6			04.04.2378	32.0	1 1/4		4	
	04.04.2355	38.0	1 1/2	6			04.04.2379	38.0	1 1/2		4	
	04.04.2356	50.8	2	4			04.04.2380	50.8	2		4	
 GRX	04.04.1297	12.7	1/2	27		 GRXZ	04.04.1307	12.7	1/2		22	
	04.04.1298	19.0	3/4	27			04.04.1308	19.0	3/4		22	
	04.04.2357	25.4	1	23			04.04.2381	25.4	1		18	
	04.04.2358	32.0	1 1/4	4			04.04.2382	32.0	1 1/4		4	
	04.04.2359	38.0	1 1/2	4			04.04.2383	38.0	1 1/2		4	
	04.04.2360	50.8	2	4			04.04.2384	50.8	2		3	
 GRB	04.04.1293	12.7	1/2	27		 GASKET	04.05.0545	75.87	2.62	10		
	04.04.1294	19.0	3/4	27			04.05.2325	129.77	3.53	10		
	04.04.2361	25.4	1	18			04.15.0451	1/2 a 1. M 85 x 2			81	
	04.04.2362	32.0	1 1/4	4			04.15.0575	1 1/4 a 2. M 136.7 x 2.5			32	
	04.04.2363	38.0	1 1/2	4								
	04.04.2364	50.8	2	4								

Expediente
 Control
 Embarques
 Almacén
 Producción

- Antes de fincar el pedido en firme, favor de confirmar con fábrica el plazo de embarque definitivo.
- Before place your order, please confirm with RAWELT definitive date of shipment.