

WIREMOLD®

Furniture Feed Style Poke-Thru Devices

Bring Power & Communication Services to Modular Furniture Systems



Protection from water, dirt, and debris.

Furniture Feed Style Poke-Thru Devices are an excellent solution for feeding power and communication services to modular furniture systems in an open space, above grade floor environment. Every Wiremold Poke-Thru Device comes with built-in TopGuard protection, an industry-leading design that meets and exceeds UL scrub water exclusion requirements for tile and carpet floors. TopGuard protection prevents water, dirt, or debris from entering the power and communication compartments through the service head or floor fittings.

All Wiremold Furniture Feed Style Poke-Thru Devices can be installed on tile, carpet, or wood covered floors and are an excellent solution for both new or retrofit construction. Typical applications include commercial office buildings, financial institutions, and government facilities.

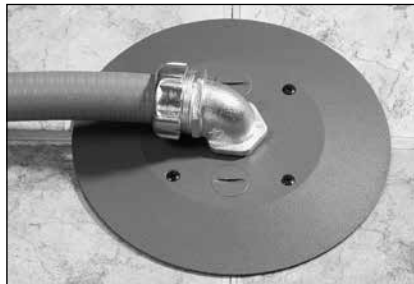

RC7AFFTC Series

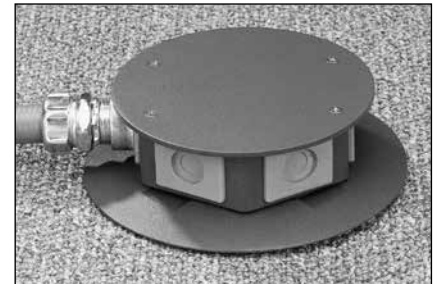

RC9AFFTC Series



RC9AM2TC Series

FEATURES & BENEFITS

- **RC9AM2 Flush Style Furniture Feed Series provides a combination 1 1/4" and 2" trade size conduit opening in cover.** UL Listed for both power and communication furniture feed applications.
- **RC9AM2 Flush Style Furniture Feed Series accepts up to 36 UTP cables.** Reduces overall project costs by eliminating the need for additional poke-thru devices in high capacity, modular furniture applications.
- **RC9AFFTC Series provides hexagonal housing with six openings for power.** Permits communication and power cables to be conduit-protected when passed through the unit.
- **RC7AFFTC Flush Style Furniture Feed Series provides one 3/4" and two 1/2" trade size conduit openings in cover.** Eliminates the cost of a second poke-thru device to accommodate power and communication services.
- **"Step-on-it" installation.** Quick and easy installation without the need for additional fasteners or the need for a second installer.
- **Fire rated for up to 2-hour rated floors.** Maintains the fire classification of the floor.
- **Communication connectivity options.** Accepts industry standard and proprietary devices from a wide range of manufacturers to provide a seamless and aesthetically pleasing interface for voice, data, audio, and video applications at the point-of-use.
- **TopGuard Protection.** Integral design component that prevents water, dirt and debris from entering power and communication compartments. Whenever you see the TopGuard protection icon on any Wiremold product, you'll know it meets and exceeds UL scrub water exclusion requirements for tile and carpet floors.
- **Suitable for use in air handling plenums in accordance with Sec. 300-22 (C) of the National Electrical Code.**
- **UL Listed and UL Fire Classified to U.S. and Canadian safety standards for tile and terrazzo.** Includes the new UL requirements under UL514A and UL 514C for the scrub water exclusion test for carpet and wood covered floors.

Furniture Feed Style Poke-Thru Device Specifications

3" Diameter Hole

POKE-THRU SERIES		RC7AFFTC Series	RC7AM2TC Series	RC9FFTC Series	RC9AM2TC Series
HOLE SIZE		Minimum: 3 1/16" (78mm) Maximum: 3 1/8" (79mm)	Minimum: 3" (76mm) Maximum: 3 1/8" (79mm)	Minimum: 3" (76mm) Maximum: 3 1/8" (79mm)	Minimum: 3" (76mm) Maximum: 3 1/8" (79mm)
UL FIRE CLASSIFICATION		Two Hours	Two Hours	Two Hours	Two Hours
UL SCRUBWATER PROTECTION		TopGuard™	TopGuard™	TopGuard™	TopGuard™
CAPACITY		2 Gangs Two (2) 1/2" & one (1) 3/4" trade size Screw Plug Openings	2 Gangs Two (2) 1/2" & one (1) 3/4" trade size Screw Plug Openings	2 Gangs Hexagonal Service Head with one (1) 1/2" trade size Conduit & five (5) Comm Openings	2 Gangs One (1) 1 1/4" Concentric Screw Plug
MAXIMUM COPPER FILL	POWER*	(10) #12 AWG .01536 Sq. in. (9.91 sq. mm)	(20) #12 AWG .01536 Sq. in. (9.91 sq. mm)	(11) #12 AWG .01536 Sq. in. (9.91 sq. mm)	(20) #12 AWG .01536 Sq. in. (9.91 sq. mm)
	COMMUNICATIONS*	(7) Cat 6A/Channel .004 Sq. in. (2.58 sq. mm)	(32) Cat 6A/Channel .004 Sq. in. (2.58 sq. mm)	(20) Cat 6A/Channel .01600 Sq. in. (10.324 sq. mm)	(32) Cat 6A/Channel .01600 Sq. in. (10.324 sq. mm)
COVER SIZE		7" (178mm)	7" (178mm)	7" (178mm)	7" (178mm)
COVER COLORS		Black, Brass, Aluminum, Gray	Black, Brass, Aluminum, Gray	Black, Brass, Aluminum, Gray	Black, Brass, Aluminum, Gray
COVER CONSTRUCTION		Die-Cast	Die-Cast	Die-Cast	Die-Cast
CONDUIT/STEM DIAMETER		One (1) 3/4" & two (2) 1/2" trade size Conduit	One (1) 2" trade size Conduit	One (1) 3/4" & two (2) 1/2" trade size	One (1) 2" trade size Conduit
FLOOR COVERING THICKNESS		Minimum: 1/8" (3.2mm) Maximum: 3/4" (19.1mm)	Minimum: 1/8" (3.2mm) Maximum: 3/4" (19.1mm)	Minimum: 1/8" (3.2mm) Maximum: 3/4" (19.1mm)	Minimum: 1/8" (3.2mm) Maximum: 3/4" (19.1mm)

* The above maximum copper fill values are the maximum amount of copper to maintain fire classification and are for each individual power and communication compartments. Do not add values together for any one compartment.



Download this product's PEP ecopassport® environmental product declaration at www.legrand.us/resources-and-downloads. This declaration conforms with ISO 14025 and 14040 and is in alignment with EN 15804.

Furniture Feed Style Poke-Thru Device Specifications

Copper Cross Section:

The copper cross-sectional area determines the amount of wire fill capacity in a poke-thru device. Unlike other wire and cable management systems that utilize wire fill capacity, a poke-thru device is UL tested under fire conditions to determine the maximum amount of copper conductors that will pass through a poke-thru device, while maintaining the fire-rating of the concrete slab. All Walker Flush Style Devices are UL Classified to U.S. and Canadian safety standards (see complete marking on product) to accommodate at a maximum rating as follows:

RC7AFFTC SERIES

Maximum Allowable Copper Cross-Sectional Area:

RC7AFFTC Power Compartment Only = .05214 sq. in. (33.64mm²)

RC7AFFTC Each Communication Compartment Only = .05000 sq. in. (32.26mm²)

NOTE: The RC7AFFTC Series requires a 3" (76mm) cored hole.
(American made core bit having an outside diameter of 3 1/16" (78mm).)

RC9AFFTC SERIES

Maximum Allowable Copper Cross-Sectional Area:

RC9AFFTC Power Compartment Only = .05726 sq. in. (36.94mm²)

RC9AFFTC Each Communication Compartment Only = .06425 sq. in. (41.45mm²)

NOTE: The RC9AFFTC Series requires a 3" (76mm) cored hole.
(American made core bit having an outside diameter of 3 1/16" (78mm).)

RC9AM2TC SERIES

Maximum Allowable Copper Cross-Sectional Area:

RC9AM2TC when power cables are used = .09216 sq. in. (59.46mm²)

RC9AM2TC when communication cables are used = .09216 sq. in. (59.46mm²)

NOTE: The RC9AM2TC Series requires a 3" (76mm) cored hole.
(American made core bit having an outside diameter of 3 1/16" (78mm).)

I M P O R T A N T !

The above maximum copper cross sectional area values are for each individual power and communication compartment. DO NOT add values together for any one compartment.

Floor Coverings:

The poke-thru device is fire rated for carpet and wood covered floors, tile floor coverings up to 3/4" (19.1mm) maximum thickness, and linoleum floor coverings up to a maximum of 1/8" (3.2mm) thickness. For other floor coverings not listed above, consult factory.

CAUTION: These devices meet all UL scrub water requirements, but are not suitable for wet or damp locations, or other areas subject to saturation with water or other liquids such as commercial kitchens.

Concrete Thickness Min/Max:

1-HOUR RATED FLOOR – 2 1/4" (57mm) min over top of deck (or 3" (76mm) thick reinforced concrete slab) to a maximum of 7 1/2" (191mm).

2-HOUR RATED FLOOR – 3 1/4" (83mm) min over top of deck (or 4" (102mm) thick reinforced concrete slab) to a maximum of 7 1/2" (191mm).

Copper Cross Sectional Area of Commonly Used Conductors

Size	Solid	
#24	.00032 sq. in.	(.206mm ²)
#22	.00050 sq. in.	(.322mm ²)
#14	.00323 sq. in.	(2.083mm ²)
#12	.00512 sq. in.	(3.303mm ²)
#10	.00815 sq. in.	(5.258mm ²)
#8	.01296 sq. in.	(8.361mm ²)

NOTE: Use above values for solid or stranded conductors.

CAUTION! Core bits vary in size from manufacturer to manufacturer:

- Use a 3" (76mm) American made core bit having an outside diameter of 3 1/16" (78mm). Minimum hole diameter 3 1/16" (78mm).

3 1/16" HOLE SIZE POKE-THRU DEVICES

RC7AFFTC Poke-Thru Series Ordering Information

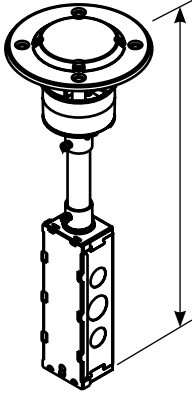
Catalog No./Item	Description/Specifications
RC7STC  <p style="text-align: right; margin-right: 20px;">16 1/2" (419mm)</p>	Insert Stem with Disposable Plate – Use with RC7CFF Series covers to form a complete poke-thru assembly. <p>NOTE: Not designed to work with bare concrete or terrazzo floors.</p>

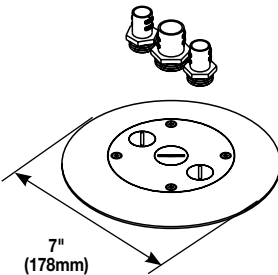
Catalog No./Item	Description/Specifications
RC7CFFTCGY RC7CFFTCBK RC7CFFTCAL RC7CFFTCBS  <p style="text-align: center; margin-top: 10px;">7" (178mm)</p>	Finish Flange and Conduit Adapter Assembly – Complete with one 3/4" and two 1/2" trade size conduit adapters and closure plugs. Colors available in painted black (BK), gray (GY), forged brushed aluminum (AL), and brass (BS). Use with the RC7STC Insert to form a complete poke-thru assembly. <p>NOTE: Assembled with scrub water gasket. For use on tile or carpet floors.</p> <p>NOTE: Not designed to work with bare concrete or terrazzo floors.</p> <p>NOTE: Minimum floor covering thickness 1/8" (3.2mm).</p>

Catalog Number Explanation				
RC7AFFTCAL				
RC7	A	FF	TC	AL
Identifies Poke-Thru Series	Identifies Assembled Unit (A) or Cover (C)	Designates Unit Is for Furniture Feed Applications	Identifies that Unit is Approved for Tile and Carpet Floors	Identifies Color of Finish Flange

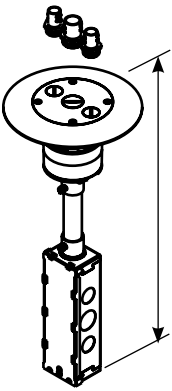
RC7AFFTCGY RC7AFFTCBK RC7AFFTCAL RC7AFFTCBS  <p style="text-align: right; margin-right: 20px;">16 1/2" (419mm)</p>	Flush Furniture Feed Poke-Thru Assembly – Complete with one-piece finish flange and conduit assembly with one 3/4" and two 1/2" trade size conduit adapters and closure plugs. Colors available in painted aluminum, black (BK), gray (GY), forged brush aluminum (AL), and brass (BS). <p>NOTE: Assembled with scrub water gasket. For use on tile or carpet floors.</p> <p>NOTE: Not designed to work with bare concrete or terrazzo floors.</p>
---	--

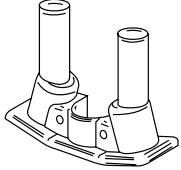
COM50 COM75 	Communication Adapter – For two 1/2" trade size conduit connections (COM50). For two 3/4" trade size conduit connections (COM75). <p>NOTE: No additional capacity with COM75.</p>
---	--

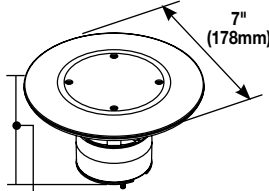
ABPLUG3  <p style="text-align: center; margin-top: 10px;">7" (178mm)</p> <p style="margin-top: 10px;">3 3/16" (97mm)</p>	Abandonment Plug Assembly – Complete plug assembly for abandoning an open 3" (76mm) cored-hole. Assembly includes intumescent fire-stop material to maintain the fire-classification of the floor, integral retainer ring to prevent the unit from pulling up through the floor, and a black die-cast aluminum cover. <p>NOTE: Not designed to work with bare concrete or terrazzo floors.</p>
--	---

Hole Size Chart		
	Hole Size Minimum	Hole Size Maximum
RC7AFFTC	3 1/16" (78mm)	3 1/8" (79mm)
RC7STC	3 1/16" (78mm)	3 1/8" (79mm)
ABPLUG3	3 1/16" (78mm)	3 1/8" (79mm)
RC7CFFTC	3 1/16" (78mm)	3 1/8" (79mm)

NOTE: To abandon RC7TFFTC Series, disconnect conduit adapters and install closure plugs.

NOTE: See page 6 for specifications.

3 1/16" HOLE SIZE POKE-THRU DEVICES

RC9AFFTC Poke-Thru Series Ordering Information

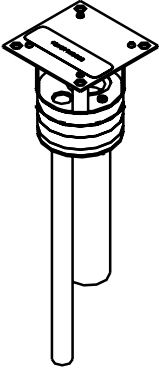
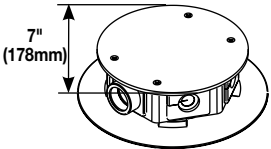
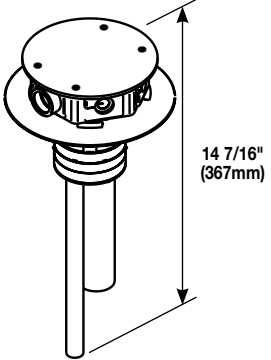
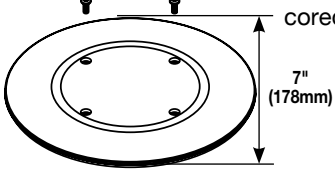
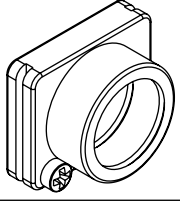
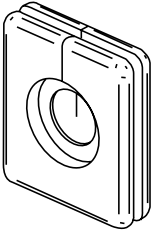
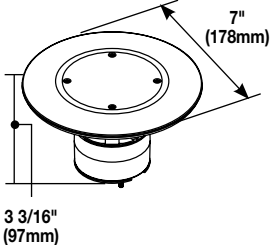
Catalog No./Item	Description/Specifications
<p>RC9FFS</p> 	<p>Insert Stem with Disposable Plate – Furniture feed insert with one 1 1/4" and one 1/2" trade size conduit to feed power and communication services. Use with RC9CFF Series covers to form a complete poke-thru assembly.</p>
<p>RC9CFFTCGY</p> 	<p>Finish Flange and Service Head Assembly – Comes complete with gray carpet flange, gray hexagonal housing, five rubber grommets, and one 3/4" trade size threaded drop-in hub. The service head includes scrub water gasket. Use with RC9FFS Insert to form a complete poke-thru assembly.</p>
<p>RC9AFFTCGY RC9AFFTCBK</p> 	<p>Assembled Furniture Feed Unit – Complete with hexagonal service head. Service head has one 3/4" trade size threaded conduit hub and five rubber grommets. The service head includes scrub water gasket. Unit is supplied with one 1 1/4" trade size conduit stem and one 1/2" trade size conduit stem to feed power and communication services. Available with a gray housing and carpet flange.</p> <p>NOTE: Service head is not to be used as a junction box. All power connections must be made in a junction box below (not supplied).</p>
<p>RCAPFFTCBK</p> 	<p>Abandonment Plate – Used to abandon fitting by removing hexagonal housing and placing plate inside the carpet flange. Insert stem must remain in the cored hole.</p>
<p>FFD-P</p> 	<p>3/4" (19.1mm) Threaded Drop-in Hub – Used to make conduit connections to the service head.</p>
<p>TG-1</p> 	<p>Drop-in Rubber Grommet for Pass-Through Cabling – Set of two grommets (one grommet shown).</p>
<p>ABPLUG3</p> 	<p>Abandonment Plug Assembly – Complete plug assembly for abandoning an open 3" (76mm) cored-hole. Assembly includes intumescent fire-stop material to maintain the fire-classification of the floor, integral retainer ring to prevent the unit from pulling up through the floor, and a black die-cast aluminum cover.</p>

NOTE: See page 6 for specifications.

3 1/16" HOLE SIZE POKE-THRU DEVICES

RC9AM2TC Poke-Thru Series Ordering Information

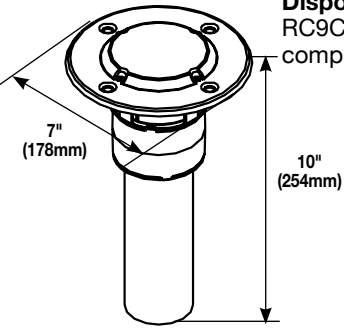
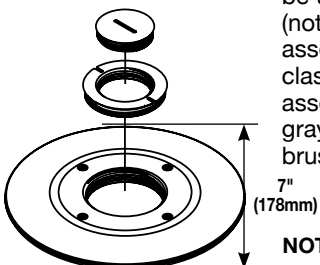
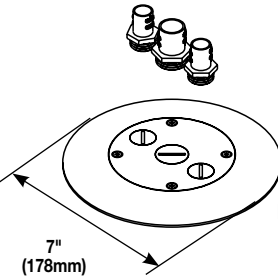
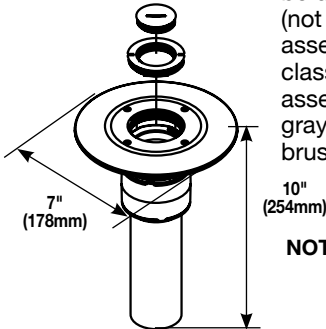
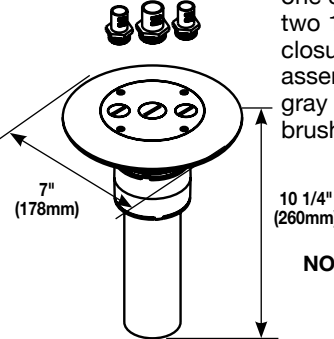
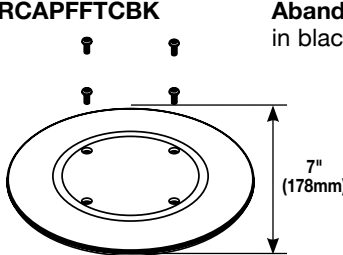
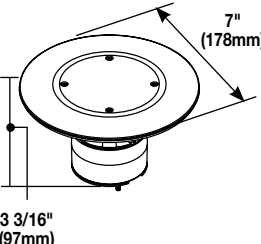
Catalog No./Item	Description/Specifications
<p>RC9AM2STC</p> 	<p>Insert Assembly with Disposable Plate – Use with RC9CM2TC Series cover to complete installation.</p>
<p>RC9CM2TCGY RC9CM2TCBK RC9CM2TCAL</p> 	<p>Furniture Feed Poke-Thru Cover Assembly – Complete with combination 1 1/4" and 2" trade size threaded conduit openings and closure plugs. Must be used with a conduit connector (not included) at the adapter assembly plate to maintain fire classification. Finish flange/cover assembly available in painted gray (GY), black (BK) and brushed aluminum (AL).</p> <p>NOTE: Assembled with scrub water gasket. For use on tile or carpet floors.</p>
<p>RC7CFFTCGY RC7CFFTCBK RC7CFFTCAL</p> 	<p>Furniture Feed Poke-Thru Cover Assembly – Complete with one 3/4" trade size conduit and two 1/2" trade size adapters and closure plugs. Colors available in painted gray (GY), black (BK), and brushed aluminum (AL). Use with RC9AM2STC. Insert stem to form a complete poke-thru assembly</p> <p>NOTE: Assembled with scrub water gasket. For use on tile or carpet floors.</p>
<p>RC9AM2TCGY RC9AM2TCBK RC9AM2TCAL</p> 	<p>Furniture Feed Poke-Thru Assembled Unit – Complete with combination 1 1/4" and 2" trade size threaded conduit openings and closure plugs. Must be used with a conduit connector (not included) at the adapter assembly plate to maintain fire classification. Finish flange/cover assembly available in painted gray (GY), black (BK) and brushed aluminum (AL).</p> <p>NOTE: Assembled with scrub water gasket. For use on tile or carpet floors.</p>
<p>RC7AM2TCGY RC7AM2TCBK RC7AM2TCAL</p> 	<p>Furniture Feed Poke-Thru Assembled Unit – 2" trade size conduit stem, complete with one 3/4" trade size conduit and two 1/2" trade size adapters and closure plugs. Finish flange/cover assembly available in painted gray (GY), black (BK), and brushed aluminum (AL).</p> <p>NOTE: Assembled with scrub water gasket. For use on tile or carpet floors.</p>
<p>RCAPFFTCBK</p> 	<p>Abandonment Plate – Available in black (BK).</p>
<p>ABPLUG3</p> 	<p>Abandonment Plug Assembly – Complete plug assembly for abandoning an open 3" (76mm) cored-hole. Assembly includes intumescent fire-stop material to maintain the fire-classification of the floor, integral retainer ring to prevent the unit from pulling up through the floor, and a black die-cast aluminum cover.</p>

NOTE: See page 6 for specifications.

Flush Poke-Thru Series Specifications (continued)

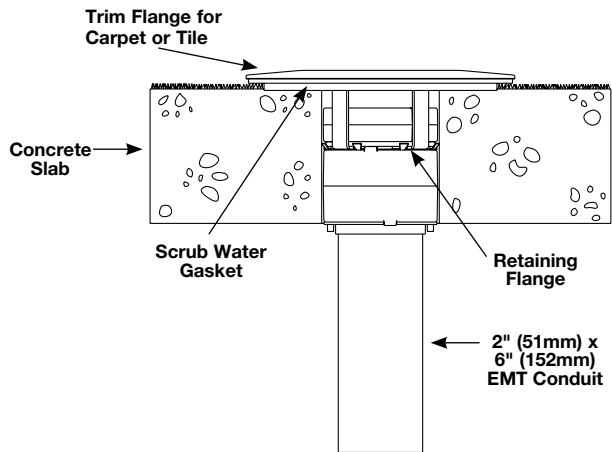
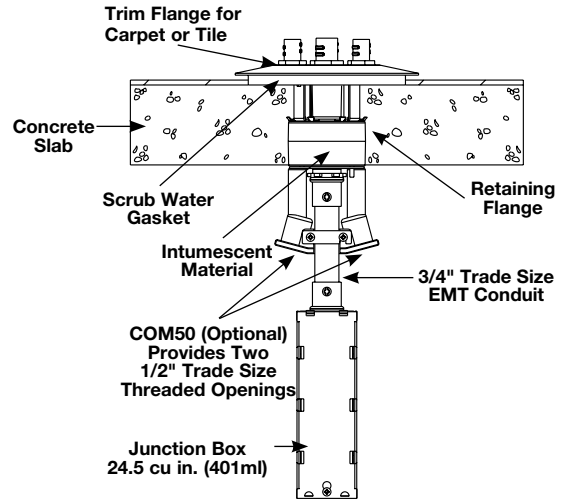
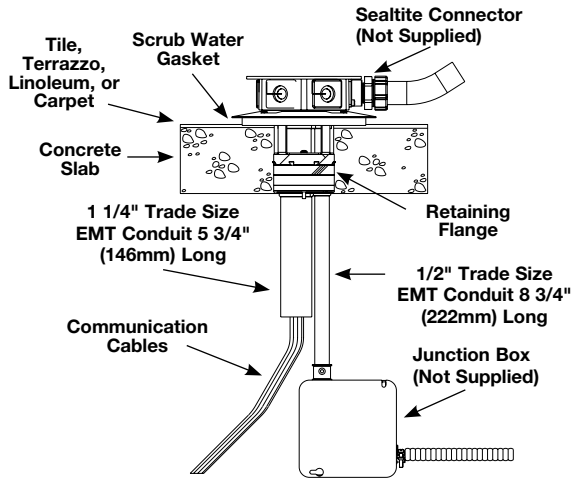

NOTE: The material that is used in Wiremold poke-thru devices is not listed under the directory for Fire Stopping Material because the poke-thru device is UL Classified as "Outlet Boxes and Fittings Classified For Fire Resistance (CEYY)". The pass/fail criteria comes from UL263. The pass criteria is that the poke-thru unit cannot exceed 325° F. above ambient before the concrete slab (or deck) reaches this same temperature. Some poke-thru devices are tested for 2 hours while others are tested for 4 hours. The intumescent material has never been tested as a fire-stopping material as a stand-alone device. This material is designed to work as a unit with the entire poke-thru device.

NOTE: All brand and product names referenced in this document are registered trademarks or trademarks of their respective holders.



NOTE: The paper used to print this document is an environmentally responsible paper with 10% post consumer waste, with FSC and SFI Chain of Custody certifications, Lacey Act compliant. 100% of the electricity used to manufacture Flo sheets is generated with Green-e certified renewable energy.



Electrical Wiring Systems

60 Woodlawn Street
West Hartford, CT 06110
Phone: 1.877.BY.LEGRAND (295-3472)
www.legrand.us

570 Applewood Crescent
Vaughan, Ontario L4K 4B4
Phone: 905.738.9195
www.legrand.ca

