



The sleek dash Furniture Power Center is designed to fit your specific needs.

## Configurable Furniture Power Center

Designed to be easily installed into furniture, the dash™ Furniture Power Center provides designers a higher degree of customization while giving users easy access and control of power and data wherever it is needed. The dash product family is built around a common set of cubes that can be configured at the factory to meet the needs of any environment.

The furniture power center is ideal for hospitality spaces allowing for control of nearby devices with the built-in switching controls. The modern design allows it to compliment any space with standard device and trim plates available in white or graphite finishes. Additional trim plates are available in stainless, bronze, and brass finishes.

### Features & Benefits

- **Easy installation.** All dash™ products are easy-to-install, requiring minimal hardware.
- **Features tamper-resistant receptacles.** Tamper-resistant receptacles protect users and devices from damage or risk of injury..
- **Slim, Modern Design.** The dash FPC is designed to blend right into any space, complementing existing decor with a minimalist design that's right on target with high end environments.
- **Front Mount Unit.** This product is required to install from the front, which is easy and flexible. Unit can be mounted vertically and horizontally.
- **RoHS, Prop 65 compliant.**
- **Future-ready.** With so many potential configurations and options, the dash™ offering is designed with the future in mind. Combine USB type A/C ports with switching and data options..
- **UL Spill Water Compliant.** Passed UL 962A Spill Water Test requirements so it can even be used in a horizontal surface such as a tabletop.
- **FCC Compliance.** This device complies with FCC Part 15, Subpart B. Operation is subject to the following two conditions: (1) this device may not cause harmful interference, and (2) this device must accept any interference received, including interference that may cause undesired operation.

Available in configurations from 2 cubes wide to a total of 6 cubes wide



Configurations available with a switch to control cord-connected lighting fixture.



### Vertical Markets

- Hospitality
- Commercial
- Education

### Compliance



UL Listed to UL962A – Standard for Furniture Power Distribution Units

## dash Furniture Power Center Configurations

The dash Furniture Power Center is highly configurable and can be made-to-order based on your desired specifications. For a list of standard configurations that are stocked, refer to pages 3 through 5. While the product is highly configurable, the cubes cannot be re-arranged in the field. To start your configuration, use our online configurator or contact your local Legrand representative.

### Configurable Options:

- **Cubes:** Can be configured from two (2) to six (6) cubes
- **Cord Length:** Standard cord lengths are available in either 6 ft. or 10 ft. Custom cord lengths of 2 ft. to 25 ft. are available with an order quantity over 500
- **Cord Side:** The cord can be specified to come out of the right (default) or left-side of the unit
- **Pass-Through Plug:** The plug can be configured with or without power pass-through
- **Color:** Cubes and trim plate come in either white or graphite finishes. Additional trim plates are available for purchase separately and include: stainless, bronze, or brass finishes



### Configuration Considerations:

- Total number of outlets cannot exceed four (4). Each switch or dimmer specified includes an outlet
- Circuit breaker is required when there are four (4) or more outlets used and must be located on the specified cord-exit side
- Data port can be specified on configurations of 3-cubes or more and must be placed on the ends of the furniture power center (cannot be specified between cubes)
- Total number of switches cannot exceed 2
- Pass-Through Plug is only specifiable when the combined number of outlets, switches, or dimmers does not exceed two (2)

### Available Cubes:

The furniture power center is comprised of several cubes that can be configured in various arrangements. The currently available cubes can be found below:

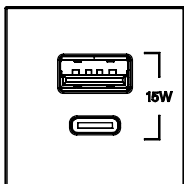

15W Combo USB  
A/C Port

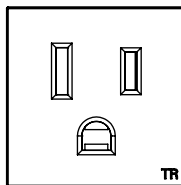

Tamper-Resistant  
15-5R Outlet

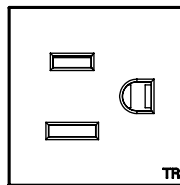

Tamper-Resistant  
15-5R Rotated Outlet

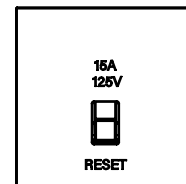

Circuit Breaker

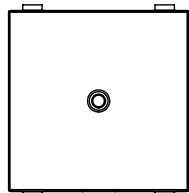

Push Button Switch

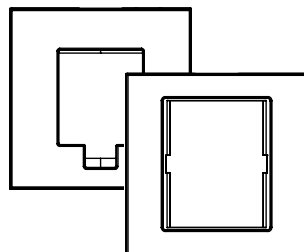

TracJack® and  
Keystone Data Port  
Adapters

## Product Specifications

Product specifications will vary depending on final product configuration. Specifications below are in reference to standard product offering.

<b>PERFORMANCE</b>	
<b>Electrical</b>	
Electrical Rating	Outlets rated 15A, 125Vac
Cord Set	Standard Offering: 6' (1.83m) right angle 5-15P Pass-Thru Plug 6' (1.83m) right angle 5-15P Plug
USB	USB Type-A & Type-C Combo: 15W Shared
<b>Mechanical</b>	
Mounting	Mounts in vertical or horizontal position. Any material from 3/8" to 1 1/4" thick
<b>Environmental</b>	
Storage Temperature	-35°C to 85°C (-31°F to 185°F)

**Warranty:** Standard One Year

**3rd Party Compliance:** cULus Listed to UL962A

## Furniture Cutout Requirements

All units require at least 1" additional spacing on back side of furniture mounting surface.

	<b>Furniture Cutout Size</b>	
	<b>Length</b>	<b>Height</b>
<b>2-Cube</b>	3.65" (93mm)	2" (51mm)
<b>3-Cube</b>	4.95" (126mm)	2" (51mm)
<b>4-Cube</b>	6.2" (157mm)	2" (51mm)
<b>5-Cube</b>	7.6" (193mm)	2" (51mm)
<b>6-Cube</b>	8.9" (226mm)	2" (51mm)

## dash Furniture Power Center Ordering Information

Catalog No./Item	Description/Specifications
------------------	----------------------------

**F2RU6PRWC**  
**F2RU6PRGC**

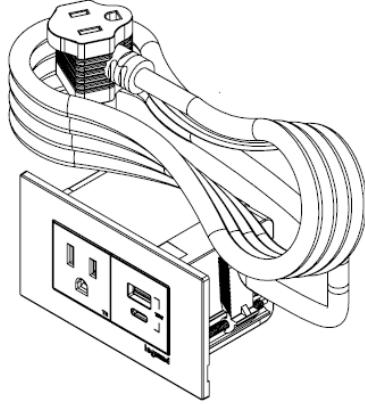

**2-Cube dash Furniture Power Center** - Unit includes, from left-to-right, 15A tamper-resistant outlet and combo 15W USB A/C port. Unit comes with a 6' (1.83m) right-exit pass-through power cord. Devices available in white (F2RU6PRWC) or graphite (F2RU6PRGC). Additional trim plate finishes are available separately in stainless, bronze, and brass finishes.

**Country of Origin:** China

**Note:** Mirror pairs of this configuration are available made-to-order and have a different country of origin (Mexico)

F2UR6PLWM  
F2UR6PLGM

### Dimensions

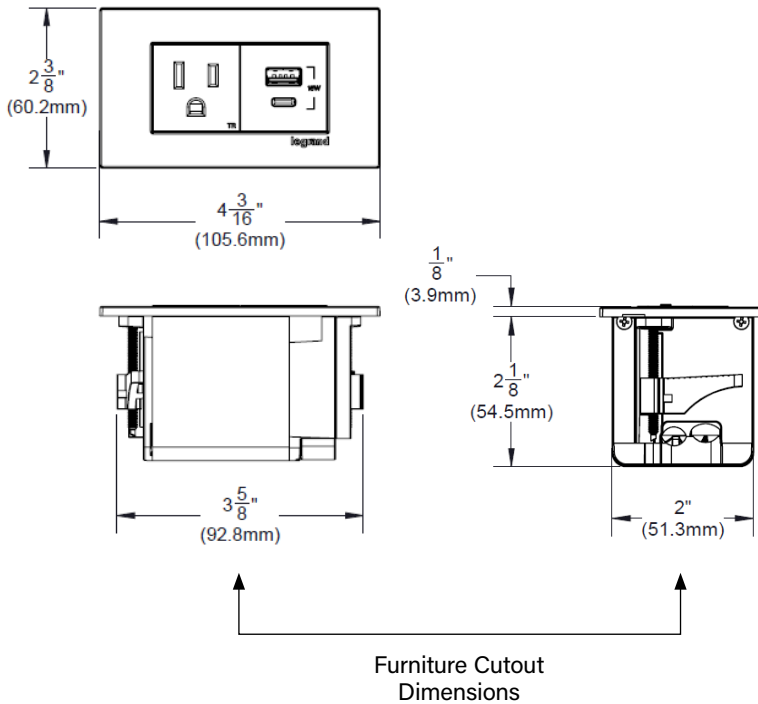

## dash Furniture Power Center Ordering Information

Catalog No./Item	Description/Specifications
------------------	----------------------------

**F3RUR6PRWC**  
**F3RUR6PRGC**

**3-Cube dash Furniture Power Center** - Unit includes, from left-to-right, 15A tamper-resistant receptacle, combo 15W USB A/C port, and 15A tamper-resistant outlet. Unit comes with a 6' (1.83m) right-exit pass-through power cord. Devices available in white (F3RUR6PRWC) or graphite (F3RUR6PRGC). Additional trim plate finishes are available separately in stainless, bronze, and brass finishes.

**Country of Origin: China**

**Note:** Mirror pairs of this configuration are available made-to-order and have a different country of origin (Mexico)

F3RUR6PLWM  
F3RUR6PLGM

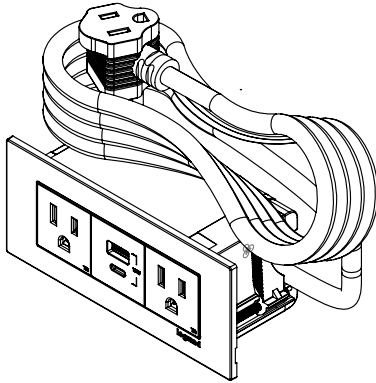

### Dimensions

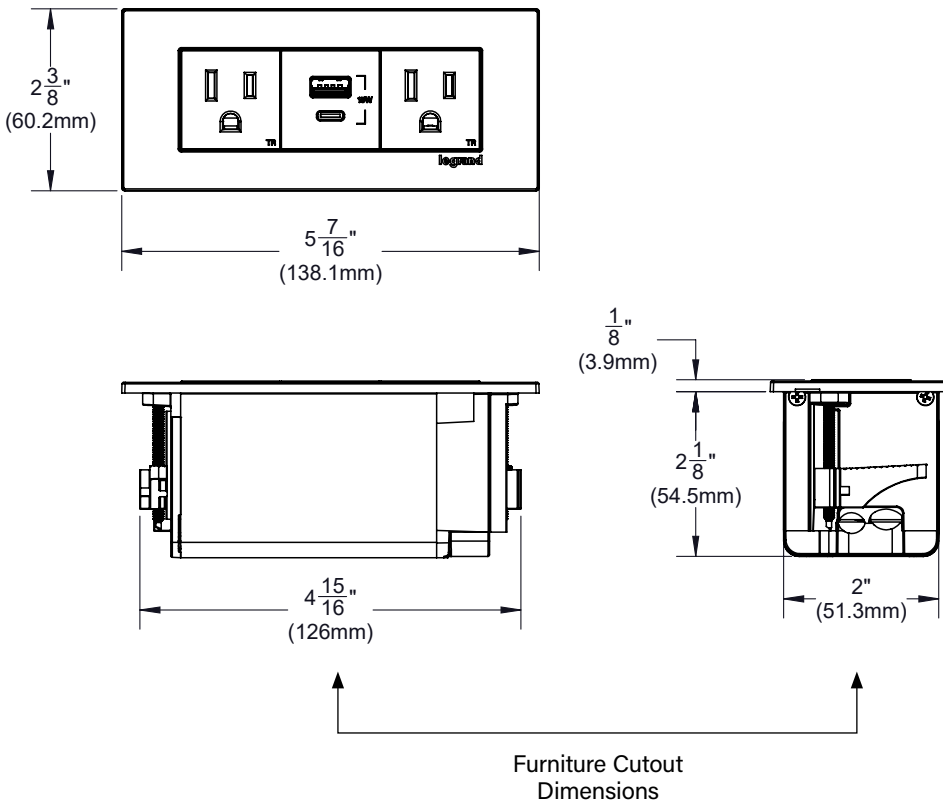

## dash Furniture Power Center Ordering Information

**Catalog No./Item**

**Description/Specifications**

**F4RRUS6NRWC**  
**F4RRUS6NRGC**

**4-Cube dash Furniture Power Center with Switching-** Unit includes, from left-to-right, two (2) 15A tamper-resistant outlets, combo 15W USB A/C port, and mechanical switch. Unit comes with a 6' (1.83m) right-exit power cord and a 10" (254mm) cord with a switch-controlled receptacle on end of cord. Devices available in white (F4RRUS6NRWC) or graphite (F4RRUS6NRGC). Additional trim plate finishes are available separately in stainless, bronze, and brass finishes.

**Country of Origin: China**

**Note:** Mirror pairs of this configuration are available made-to-order and have a different country of origin (Mexico):

F4SURR6NLWM  
F4SURR6NLGM

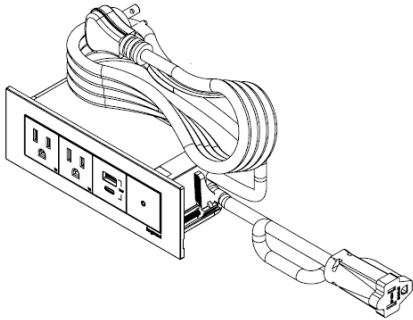

**Dimensions**

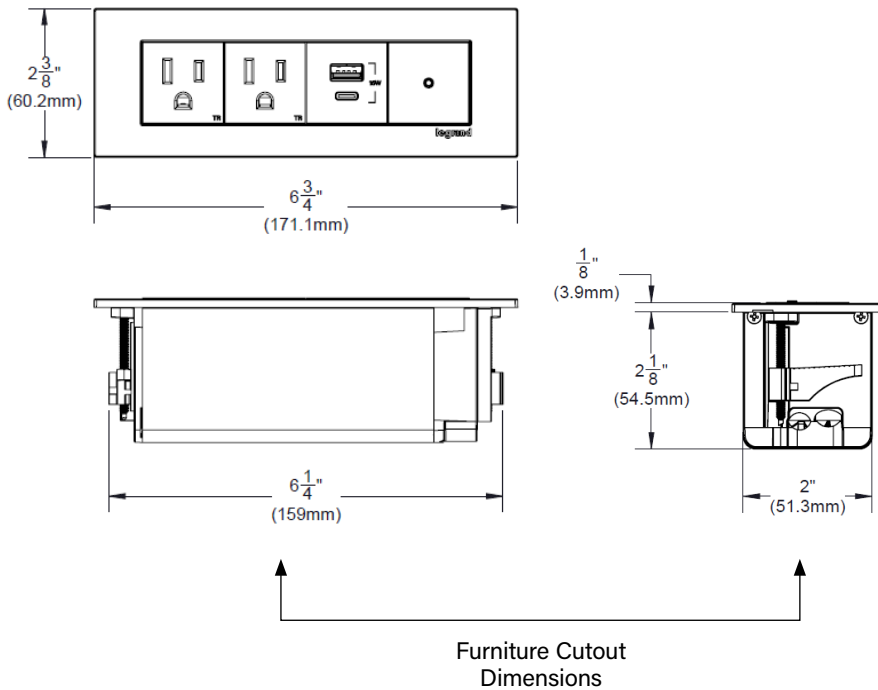

**dash Furniture Power Center Ordering Information**

Catalog No./Item	Description/Specifications
------------------	----------------------------

**F6SRRUSB6NRWM**  
**F6SRRUSB6NRGM**

**6-Cube dash Furniture Power Center with Switching (Made-to-Order)**- Unit includes, from left-to-right, mechanical switch, two (2) 15A tamper-resistant outlets, combo 15W USB A/C port, mechanical switch, and circuit breaker. Unit comes with a 6' (1.83m) right-exit power cord and two 10" (254mm) cords with a switch-controlled receptacle on end of cords. Available in white (F6SRRUSB6NRWM) or graphite (F6SRRUSB6NRGM) finishes. Additional trim plate finishes are available separately in stainless, bronze, and brass finishes.

**Country of Origin: Mexico**

**Note:** Mirror pairs of this configuration are available made-to-order:

F6BSURRS6NLWM  
F6BSURRS6NLGM

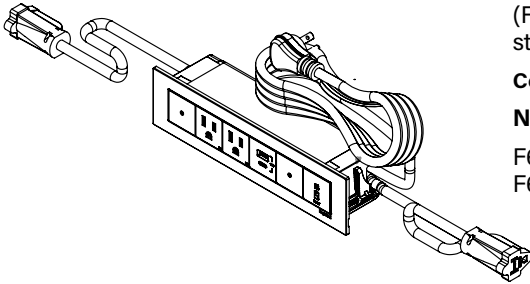

**Dimensions**

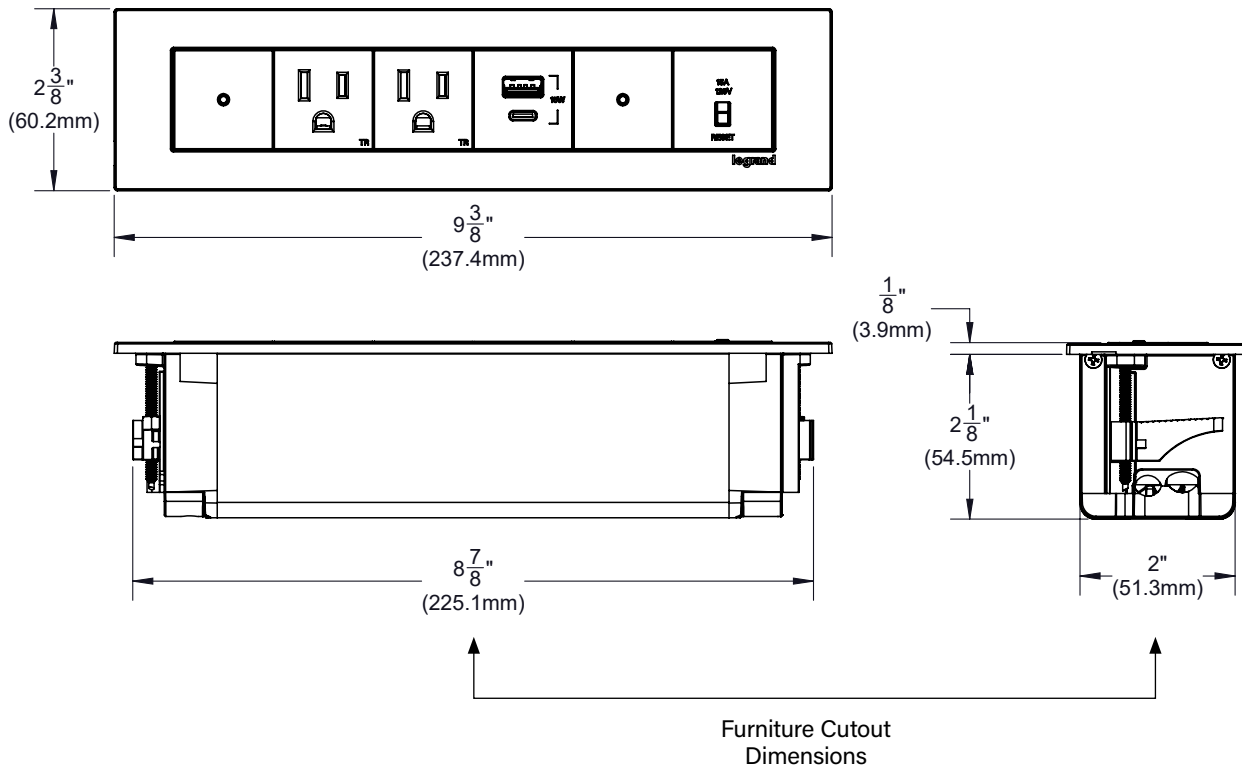

**dash Furniture Power Center Trim Plate Ordering Information**

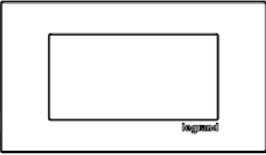
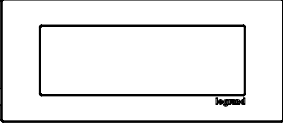
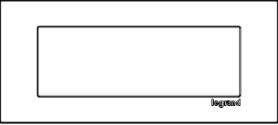
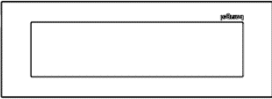
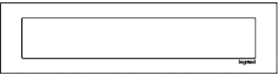
Catalog No./Item	Description/Specifications	Catalog No./Item	Description/Specifications
<b>TRIM2-ST</b> <b>TRIM2-BZ</b> <b>TRIM2-BR</b>	<b>2-Cube dash Furniture Power Center Trim Plate</b> - Trim plate compatible with 2-cube dash Furniture Power Centers. Available in stainless (ST), bronze (BZ) and brass (BR) finishes.  <b>Country of Origin: China</b>	<b>TRIM3-ST</b> <b>TRIM3-BZ</b> <b>TRIM3-BR</b>	<b>3-Cube dash Furniture Power Center Trim Plate</b> - Trim plate compatible with 3-cube dash Furniture Power Centers. Available in stainless (ST), bronze (BZ) and brass (BR) finishes.  <b>Country of Origin: China</b>
			
<b>TRIM4-ST</b> <b>TRIM4-BZ</b> <b>TRIM4-BR</b>	<b>4-Cube dash Furniture Power Center Trim Plate</b> - Trim plate compatible with 4-cube dash Furniture Power Centers. Available in stainless (ST), bronze (BZ) and brass (BR) finishes.  <b>Country of Origin: China</b>	<b>TRIM5-ST</b> <b>TRIM5-BZ</b> <b>TRIM5-BR</b>	<b>5-Cube dash Furniture Power Center Trim Plate</b> - Trim plate compatible with 5-cube dash Furniture Power Centers. Available in stainless (ST), bronze (BZ) and brass (BR) finishes.  <b>Country of Origin: China</b>
			
<b>TRIM6-ST</b> <b>TRIM6-BZ</b> <b>TRIM6-BR</b>	<b>6-Cube dash Furniture Power Center Trim Plate</b> - Trim plate compatible with 6-cube dash Furniture Power Centers. Available in stainless (ST), bronze (BZ) and brass (BR) finishes.  <b>Country of Origin: China</b>		
			

**Stainless**

**Brass**

**Bronze**

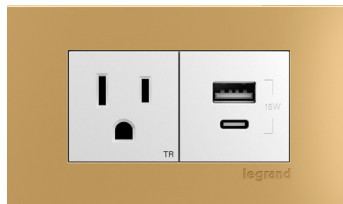
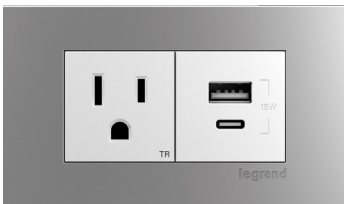



---

**NOTE: All brand and product names referenced in this document are registered trademarks or trademarks of their respective holders.**



**Legrand, North America**  
60 Woodlawn Street  
West Hartford, CT 06110  
1.877.BY.LEGRAND (295.3472)  
[www.legrand.us](http://www.legrand.us)

**Canada**  
1.800.723.5175 • 905.738.9195  
[www.legrand.ca](http://www.legrand.ca)

FOLLOW US

