

Evolution™ Series – 4/5 Gang Floor Box

Evolution™ Series Floor Boxes – The most complete and innovative line of floor boxes, just expanded with the Evolution Series 4- and 5-gang floor box.

In addition to a unique design that allows the same floor box to be used in multiple floor applications, high capacity and multi-functional capabilities make Evolution Series Floor Boxes ideal for areas where A/V, power and communication services are needed. Evolution Series Floor Boxes are an ideal option for installations where services are constantly evolving, such as commercial offices, conference rooms, stages, and entertainment venues.

New Evolution Series Floor Boxes provide increased capacity options and a variety of innovations not available in any other floor boxes.

Features & Benefits



Raised Floors



Concrete Floors



Wood Floors

- **Evolution Series Floor Boxes** are designed to work in concrete, raised and wood floor applications and are fully adjustable both pre- and post-concrete pour.
- **Configurable with removable modules.** Modules are removable through the top or back of the floor box. This allows for easier installations and facilitates moves, adds and changes without having to disconnect services, saving time and money.



- **Audio/Video Design.** Evolution Series Floor Boxes have been developed specifically with the A/V industry in mind. With 3 1/2" (89mm) of wiring capacity behind each device plate, these boxes will accept devices from leading A/V manufacturers including Legrand AVIP, Extron Electronics and Crestron..
- **Durable 180° articulating hinge.** Hinge design enables covers to open a full 180° and lie flat on the floor surface with the durability to support a large cover. Provides easy access to all interior modules and activations while reducing tripping hazards.

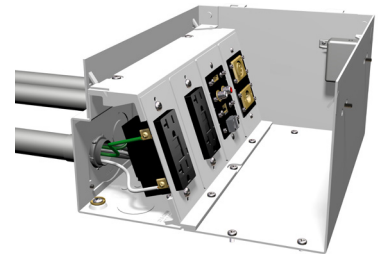

Note: If used in concrete, concrete leveling legs need to be purchased separately for all non-OG boxes.

Features & Benefits

- **Auto-close egress doors.**

Cable egress doors lock in position when open, and automatically close around wires to protect cabling and reduce trip hazards.



- **Accepts standard size wall plates.**

Evolution Series Floor Boxes accept industry standard single-, double- and triple-gang wall plates from industry leading manufacturers.



- **Finished interior.**

Fully finished interior removes the unfinished industrial look while increasing visibility, making it easier to see where to plug in devices.



- **Suitable for use in air handling spaces.**

In accordance with Sec 300-22(c) of the National Electric Code.

- **Meets ADA Accessibility Guidelines.**

Trim flange is designed to meet the ADA Accessibility Guidelines as it pertains to ADA Standard 4.5, which addresses the change in floor and ground surface levels.

- **Multiple size knockouts.**

All Evolution Series Floor Boxes are available with multiple trade size knockouts ranging in size from 3/4" to 2" allowing for multiple activations and wiring configurations.



- **Die cast aluminum cover assemblies.**

Evolution Series Floor Box Covers have been designed to work on multiple floor surfaces and are manufactured from die cast aluminum to provide strength and style. Available in the following powder coated finishes: black, gray, bronze, and durable finishes: brushed aluminum, satin brass, and satin nickel.

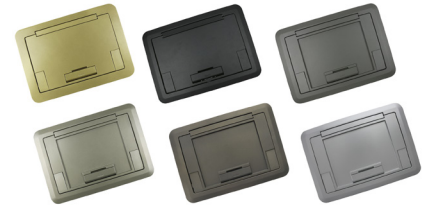

- **Cable Management.**

Allows multiple cables to be organized and controlled for easier cable egress.



- **Bare (polished) concrete and terrazzo applications.**

Evolution Series Floor Box has been designed to be installed into bare (polished) concrete and terrazzo floors.



- **TopGuard™ Protection.**

Evolution Series Floor Box covers meet and exceed UL scrub water exclusion requirements for tile, carpet, wood, bare concrete and terrazzo floor coverings.

Evolution Series EFB45 Floor Box Ordering Information

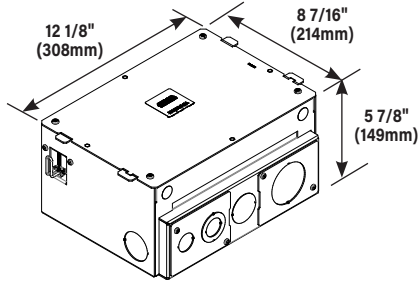

Country of Origin: Mexico

Components Included:

- A** Protective/Disposable Cover
- B** One (1) Removable Module
- C** Two (2) Toggle Clamps to secure box to raised and wood floors
- D** Two (2) Cable Management Guides
- E** Trade Size Knockouts ranging in size from 3/4" to 2" trade size

Each Module Consists of:

- One (1) EFB8-MB Mounting Bracket
- One (1) Back Plate
- Two (2) End Caps
- One (1) EFB810-DIV Divider
- One (1) EFB810 3/4"-1 1/4" Knockout Plate
- One (1) EFB810 2" Knockout Plate

NOTE: When used on bare (polished) concrete or terrazzo floors EFB45-CTR must be used. (Sold separately.)

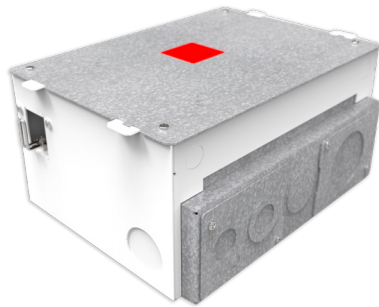

EFB45S Exploded View

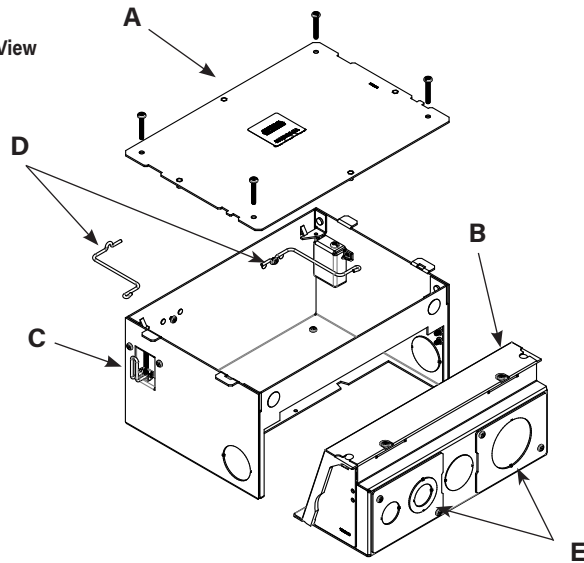

Items not included with the box and sold separately:

- Receptacles
- Communication Jacks
- A/V Devices
- Device plates
- Concrete Leveling Legs

EFB45S Depth Behind Plates

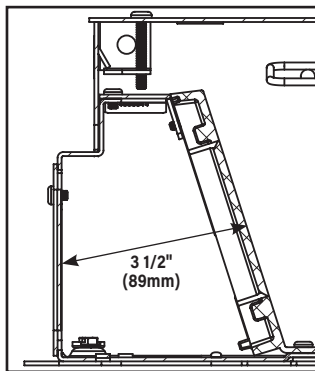

EFB45S Knockout Locations & Sizes

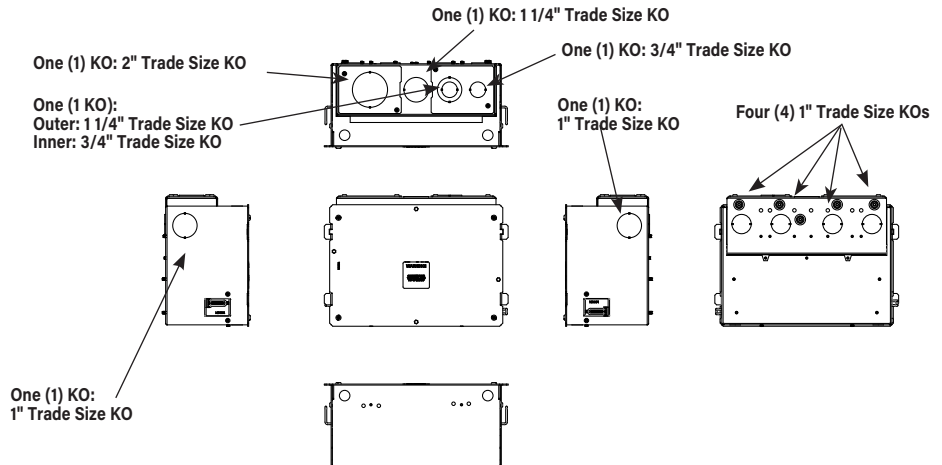

Evolution Series EFB45 Floor Box Ordering Information

Catalog No./Item

Description/Specifications

EFB45S-OG

4-Gang Floor Box - has been designed to be installed in both on-grade and above grade concrete floor applications. Box has an epoxy coating that allows the box to be placed in on-grade applications without the need for additional vapor barriers. Designed to work with standard size wall plates. **Box comes complete with all components needed for initial installation.** Custom options are available upon request.

Country of Origin: Mexico

Components Included:

- A Protective/Disposable Cover
- B One (1) Removable Module
- C Two (2) Cable Management Guides
- D Two (2) Leveling Support Legs for concrete applications
- E Trade Size Knockouts ranging in size from 1" to 2" trade size

Each Module Consists of:

- One (1) EFB8-MB Mounting Bracket
- One (1) Back Plate
- One (1) EFB810-DIV Divider

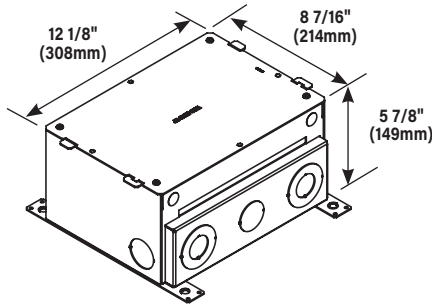

NOTE: When used on bare (polished) concrete or terrazzo floors EFB45-CTR must be used. (Sold separately.)



Items not included with the box and sold separately:

- Receptacles
- Communication Jacks
- A/V Devices
- Device plates

EFB45S-OG Exploded View

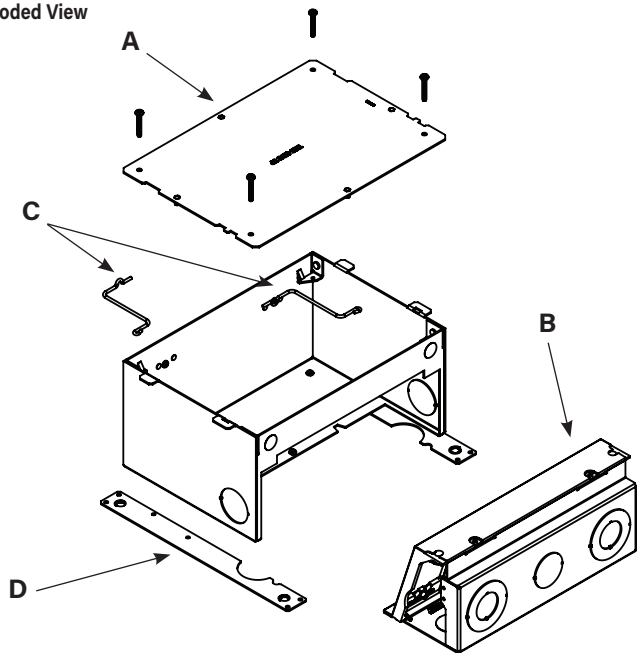

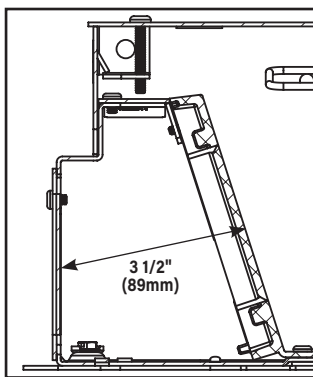

EFB45S-OG Depth Behind Plates



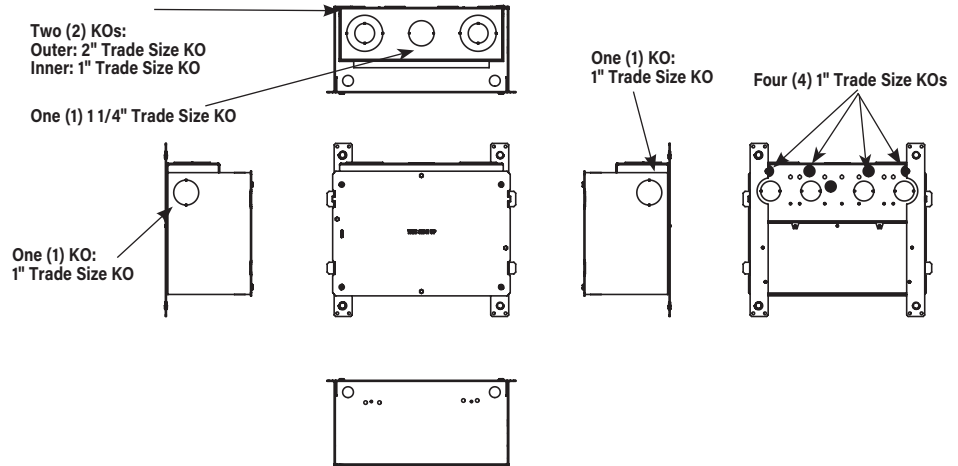

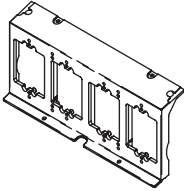
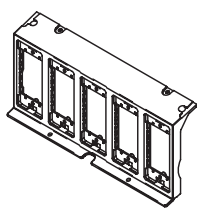
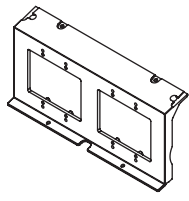
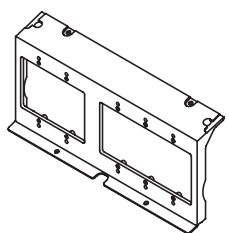
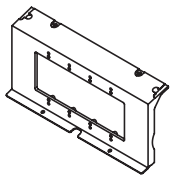
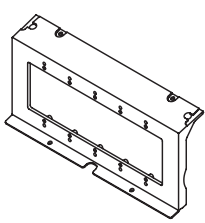
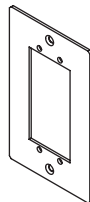
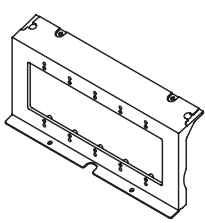
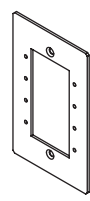
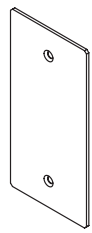
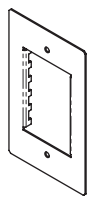
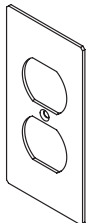

EFB45S-OG Knockout Locations & Sizes

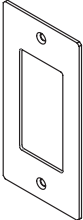
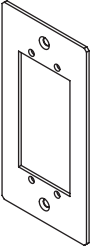

Evolution Series EFB45 Floor Box Accessories Ordering Information

Catalog No./Item	Description/Specifications	Catalog No./Item	Description/Specifications
EFB8-MB 	Mounting Bracket – Holds up to four (4) devices for power, communications or audio/video. Bracket accepts standard size (2 3/4" x 4 1/2" (70mm x 114mm)) device plates sold separately by others. Country of Origin: USA	EFB10-MB 	Mounting Bracket – Holds up to five (5) devices for power, communications or audio/video. Bracket accepts EFB10 Series device plates (2 1/32" x 4 5/8") (58mm x 117mm) and 5507 Series device plates. Sold separately. Country of Origin: USA
EFB8-22GMB 	Mounting Bracket – Equipped with two (2) 2-gang standard size device openings for a standard 2-gang (4 9/16" x 4 1/2" (116mm x 114mm)). Ideal for 2-gang A/V devices such as Crestron® 2-gang digital media devices. Device plates and devices supplied by others. Country of Origin: USA	EFB10-23GMB 	Mounting Bracket – Equipped with one 2-gang standard size device opening and one 3-gang standard size device opening. Accepts a standard 2-gang (4 9/16" x 4 1/2" (116mm x 114mm)) and a 3-gang (6 3/8" x 4 1/2" (162mm x 114mm)) device plate. Ideal for 2-gang A/V devices such as Crestron® 2-gang and 3-gang digital media devices. Device plates and devices supplied by others. Country of Origin: USA
EFB8-4GMB 	Mounting Bracket – Holds a standard 4-gang device plate. Device plate dimensions: 8 3/16" x 4 1/2" (208mm x 114mm). Country of Origin: USA	EFB10-5GMB 	Mounting Bracket – Holds a standard 5-gang device plate. Device plate dimensions: 9 9/16" x 4 1/2" (243mm x 114mm). Country of Origin: USA
EFB-AAP 	Device Plate – Holds two (2) Extron Electronics AAP devices. Device plate dimensions: 2 3/4" x 4 1/2" (70mm x 114mm). Country of Origin: USA	EFB10-5GMB 	Mounting Bracket – Holds a standard 5-gang device plate. Device plate dimensions: 9 9/16" x 4 1/2" (243mm x 114mm). Country of Origin: USA
EFB-MAAP 	Device Plate – Holds four (4) Legrand AVIP or Extron Electronics MAAP devices. Device plate dimensions: 2 3/4" x 4 1/2" (70mm x 114mm). Country of Origin: USA	EFB10-B 	Blank Device Plate – Device plate dimensions: 2 5/16" x 4 5/8" (58mm x 118mm). Country of Origin: USA
EFB-MOS 	Device Plate – European device plate accepts up to (45mm x 67.5mm) Arteor device. Device plate dimensions: 2 3/4" x 4 1/2" (70mm x 114mm). Country of Origin: USA NOTE: Not designed to accept adorne style devices.	EFB10-DP 	Duplex Device Plate – Device plate dimensions: 2 5/16" x 4 5/8" (58mm x 118mm). Includes receptacle spacers. Country of Origin: USA
EFB-B 	Blank Device Plate – Device plate dimensions: 2 3/4" x 4 1/2" (70mm x 114mm). Country of Origin: USA		

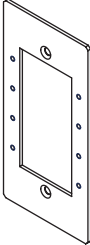
Evolution Series EFB45 Floor Box Accessories Ordering Information

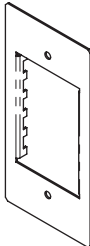
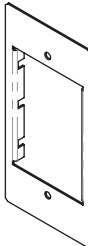
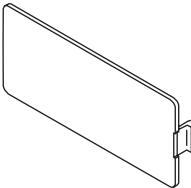
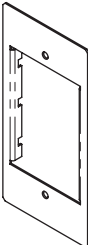
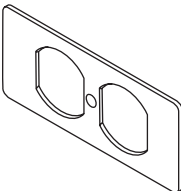
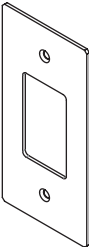
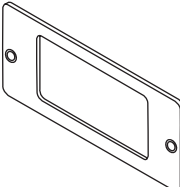
Catalog No./Item	Description/Specifications	Catalog No./Item	Description/Specifications
EFB10-DEC	 <p>Decorator Style Device Plate – For use with decorator style receptacles, GFCI receptacle, and decorator style audio/video devices. Device plate dimensions: 2 5/16" x 4 5/8" (58mm x 118mm). Includes receptacle spacers. Country of Origin: USA</p>	EFB10-AAP	 <p>Device Plate – holds two (2) Extron Electronics AAP devices. Device plate dimensions: 2 5/16" x 4 5/8" (58mm x 118mm). Country of Origin: USA</p>
EFB10-S1	 <p>Single Receptacle Plate – Single receptacle 1 3/8" (35mm) diameter. Device plate dimensions: 2 5/16" x 4 5/8" (58mm x 118mm). Includes receptacle spacers. Country of Origin: USA</p>	EFB10-MAAP	 <p>Device Plate – holds four (4) Legrand AVIP or Extron Electronics MAAP devices. Device plate dimensions: 2 5/16" x 4 5/8" (58mm x 118mm). Country of Origin: USA</p>
EFB10-S2	 <p>Single Receptacle Plate – Single receptacle 1 9/16" (40mm) diameter. Device plate dimensions: 2 5/16" x 4 5/8" (58mm x 118mm). Includes receptacle spacers. Country of Origin: USA</p>	EFB10-MOS	 <p>Device Plate – (45mm x 67.5mm) device plate. Device plate dimensions: 2 5/16" x 4 5/8" (58mm x 118mm). Country of Origin: USA NOTE: Not designed to work with adorne devices.</p>
EFB10-6AB	 <p>Device Plate – Accepts up to three (3) dual Wiremold Open System CM2 Series communication adapters. Adapters sold separately. Device plate dimensions: 2 5/16" x 4 5/8" (58mm x 118mm). Country of Origin: USA</p>	5507B-WH	 <p>Blank Faceplate – For covering unused compartments in the device bracket. Country of Origin: USA</p>
EFB10-3S2	 <p>Device Plate – Accepts up to three (3) Ortronics® Series II devices. Ortronics® devices sold separately. Device plate dimensions: 2 5/16" x 4 5/8" (58mm x 118mm). Country of Origin: USA</p>	5507D-WH	 <p>Duplex Receptacle Faceplate – For covering duplex style devices. Accepts 106 frame. Country of Origin: USA</p>
EFB10-2C	 <p>Device Plate – Accepts one dual Wiremold Open System adapter, or one Ortronics® Series II adapter, or one Ortronics® TracJack adapter. Adapters sold separately. Device plate dimensions: 2 5/16" x 4 5/8" (58mm x 118mm). Country of Origin: USA</p>	5507R-WH	 <p>Rectangular Receptacle Faceplate – For covering rectangular decorator style devices. Country of Origin: USA</p>

Evolution Series EFB45 Floor Box Accessories Ordering Information

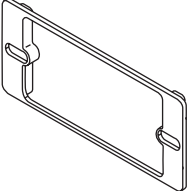
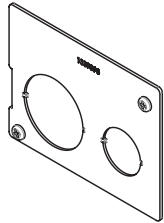
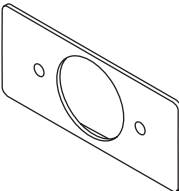
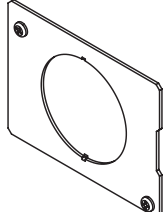
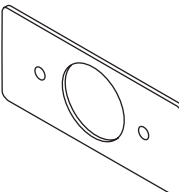
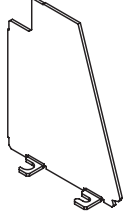
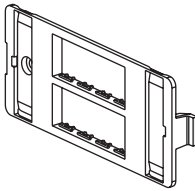
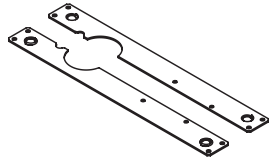
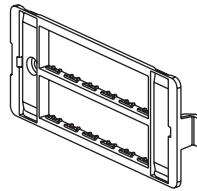
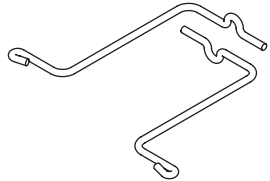
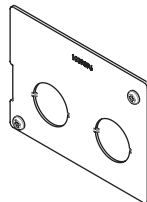
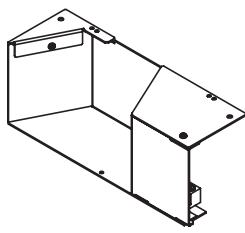
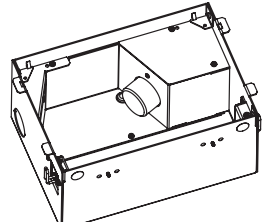
Catalog No./Item	Description/Specifications	Catalog No./Item	Description/Specifications
5507S-WH 	Rectangular Spacer – For mounting commercial device plates. Installs between the device bracket and a device. Country of Origin: USA	EFB810-3/4-11/4 	Knockout Plate – Has one 3/4" and one 1 1/4" trade size knockout. Country of Origin: USA
5507T1-WH 	Single Receptacle Faceplate – For covering single receptacles – 1 9/16" (40mm) in diameter. Country of Origin: USA	EFB810-2 	Knockout Plate – Has one 2" trade size knockout. Country of Origin: USA
5507T2-WH 	Single Receptacle Faceplate – For covering single receptacles – 1 3/8" (35mm) in diameter. Country of Origin: USA	EFB810-DIV 	Relocatable Divider – Provides separation of services. Includes one divider plate. Country of Origin: USA
55074TJ-WH 	Ortronics® Faceplate – For mounting Ortronics® datacom inserts. Accepts four (4) TracJack devices. Country of Origin: USA	EFB45-CLL 	Concrete Leveling Legs – Legs allow floor box to be adjusted up or down to match the desired pour height of the concrete. Includes two (2) leveling legs. Threaded rod not supplied. Country of Origin: Mexico
55076TJ-WH 	Ortronics® Faceplate – For mounting Ortronics® datacom inserts. Accepts six (6) TracJack devices. Country of Origin: USA	EFB45-CMG 	Cable Management Guides – Guides help organize and maintain cable position when opening and closing the cover. Country of Origin: Mexico
EFB810-3/4-3/4 	Knockout Plate – Has two (2) 3/4" trade size knockouts. Country of Origin: USA	EFB45-50A 	50A Adapter – Allows for a 50A device to be installed on the Evolution Series 4- and 5-Gang Floor Boxes. 

Evolution Series EFB45 Floor Box Covers Ordering Information

Catalog No./Item	Description/Specifications
Powder Coated: EFB45CTCBK EFB45CTCGY EFB45CTCBZ	Surface Style Cover with Floor Insert – Low profile cover designed to attach to the EFB45S style floor boxes. Each cover is made of die cast aluminum and is equipped with a durable hinge allowing the cover to rotate open 180°, a 1/4" deep recessed area to accept the finished floor covering, and two (2) slide egress doors that lock in the open position and automatically close around the cables when the cover is closed. The flange has a beveled edge that meets ADA guidelines and reduces tripping hazards. These cover assemblies are designed to sit on top of finished floors such as: carpet, tile, wood, polished concrete, and terrazzo. Available in the following powder coated finishes: black (BK), gray (GY), bronze (BZ), and durable finishes: brushed aluminum (AA), satin brass (SB), and satin nickel (SN).
Durable Finishes: EFB45CTCAA EFB45CTCSB EFB45CTCSN	

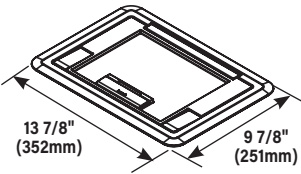

Country of Origin: India

NOTE: Depth of recess area in plate is 1/4" (6.35mm).

Catalog No./Item	Description/Specifications
Powder Coated: EFB45CTBK EFB45CTGY EFB45CTBZ	Flush Style Cover with Floor Insert – Low profile cover designed to attach to the EFB45S style floor boxes. Each cover is made of die cast aluminum and is equipped with a durable hinge allowing the cover to rotate open 180°, a 1/4" deep recessed area to accept the finished floor covering, and two (2) slide egress doors that lock in the open position and automatically close around the cables when the cover is closed. The cover assemblies are designed to sit flush with the finished floors such as: carpet, tile, and wood. In order to make the cover assembly flush with the polished concrete or terrazzo floor the EFB45-CTR (concrete/terrazzo) ring must be used (ring sold separately). Available in the following powder coated finishes: black (BK), gray (GY), bronze (BZ), and durable finishes: brushed aluminum (AA), satin brass (SB), and satin nickel (SN)..
Durable Finishes: EFB45CTAA EFB45CTSB EFB45CTSN	

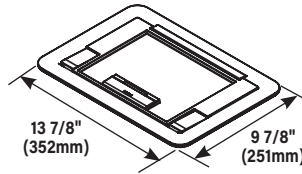

Country of Origin: India

NOTE: Depth of recess area in plate is 1/4" (6.35mm).

Catalog No./Item	Description/Specifications
Powder Coated: EFB45BTCBK EFB45BTCTGY EFB45BTCTBZ	Surface Style Cover With Solid Lid – Low profile cover designed to attach to the EFB45S style floor boxes. Each cover is made of die cast aluminum and is equipped with a durable hinge allowing the cover to rotate open 180°, and two (2) slide egress doors that lock in the open position and automatically close around the cables when the cover is closed. The flange has a beveled edge that meets ADA guidelines and reduces tripping hazards. These cover assemblies are designed to sit on top of finished floors such as: carpet, tile, wood, polished concrete, and terrazzo. Available in the following powder coated finishes: black (BK), gray (GY), bronze (BZ), and durable finishes: brushed aluminum (AA), satin brass (SB), and satin nickel (SN).
Durable Finishes: EFB45BTCAA EFB45BTCSB EFB45BTCSN	

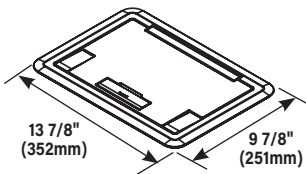

Country of Origin: India

Catalog No./Item	Description/Specifications
Powder Coated: EFB45BTBK EFB45BTGY EFB45BTBZ	Flush Style Cover with Solid Lid – Low profile cover designed to attach to the EFB45S style floor boxes. Each cover is made of die cast aluminum and is equipped with a durable hinge which allows the cover to rotate open 180°, and two (2) slide egress doors that lock in the open position and automatically close around the cables when the cover is closed. The cover assemblies are designed to sit flush with the finished floors such as: carpet, tile, and wood. In order to make the cover assembly flush with the polished concrete or terrazzo floor the EFB45-CTR (concrete/terrazzo) ring must be used (ring sold separately). Available in the following powder coated finishes: black (BK), gray (GY), bronze (BZ), and durable finishes: brushed aluminum (AA), satin brass (SB), and satin nickel (SN)..
Durable Finishes: EFB45BTAA EFB45BTBZ EFB45BTSN	

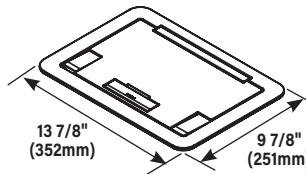

Country of Origin: India

Evolution Series EFB45 Floor Box Covers Ordering Information

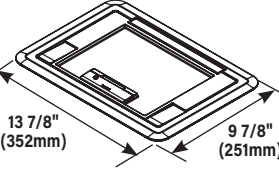
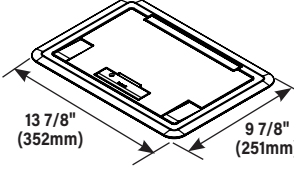
Catalog No./Item	Description/Specifications	Catalog No./Item	Description/Specifications
<p>Powder Coated: EFB45CTCBKTR EFB45CTCGYTR EFB45CTCBZTR</p> <p>Durable Finishes: EFB45CTCAATR EFB45CTCSBTR EFB45CTCSNTR</p> 	<p>Surface Style Cover with Floor Insert – Low profile cover designed to attach to the EFB45S style floor boxes. Each cover is made of die cast aluminum and is equipped with a tamper-resistant screw to help keep out unauthorized personnel, a durable hinge which allows the cover to rotate open 180°, a 1/4" deep recessed area to accept the finished floor covering, and two (2) slide egress doors that lock in the open position and automatically close around the cables when the cover is closed. The flange has a beveled edge that meets ADA guidelines and reduces tripping hazards. These cover assemblies are designed to sit on top of the finished floors such as: carpet, tile, wood, polished concrete, and terrazzo. Available in the following powder coated finishes: black (BK), gray (GY), bronze (BZ), and durable finishes: brushed aluminum (AA), satin brass (SB), and satin nickel (SN).</p> <p>Country of Origin: India</p>	<p>Powder Coated: EFB45BTCBKTR EFB45BTCGYTR EFB45BTCBZTR</p> <p>Durable Finishes: EFB45BTCAATR EFB45BTCSBTR EFB45BTCSNTR</p> 	<p>Surface Style Cover with Solid Lid – Low profile cover designed to attach to the EFB45S style floor boxes. Each cover is made of die cast aluminum and is equipped with a tamper-resistant screw to help keep out unauthorized personnel, a durable hinge which allows the cover to rotate open 180°, a 1/4" deep recessed area to accept the finished floor covering, and two (2) slide egress doors that lock in the open position and automatically close around the cables when the cover is closed. The flange has a beveled edge that meets ADA guidelines and reduces tripping hazards. These cover assemblies are designed to sit on top of the finished floors such as: carpet, tile, wood, polished concrete, and terrazzo. Available in the following powder coated finishes: black (BK), gray (GY), bronze (BZ), and durable finishes: brushed aluminum (AA), satin brass (SB), and satin nickel (SN).</p> <p>Country of Origin: India</p>
<p>NOTE: Depth of recess area in plate is 1/4" (6.35mm).</p>			

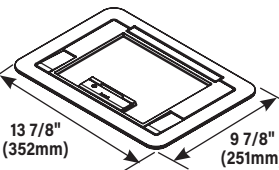
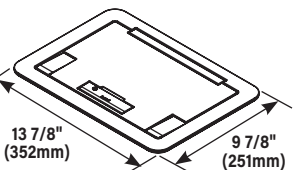
<p>Powder Coated: EFB45CTBKTR EFB45CTGYTR EFB45CTBZTR</p> <p>Durable Finishes: EFB45CTAATR EFB45CTSBTR EFB45CTSNTR</p> 	<p>Flush Style Cover with Floor Insert – Low profile cover designed to attach to the EFB45S style floor boxes. Each cover is made of die cast aluminum and is equipped with a tamper-resistant screw to help keep out unauthorized personnel, a durable hinge which allows the cover to rotate open 180°, a 1/4" deep recessed area to accept the finished floor covering, and two (2) slide egress doors that lock in the open position and automatically close around the cables when the cover is closed. The cover assemblies are designed to sit flush with the finished floors such as: carpet, tile, and wood. In order to make the cover assembly flush with the polished concrete or terrazzo floor the EFB45-CTR (concrete/terrazzo) ring must be used (trim ring sold separately). Available in the following powder coated finishes: black (BK), gray (GY), bronze (BZ), and durable finishes: brushed aluminum (AA), satin brass (SB), and satin nickel (SN).</p> <p>Country of Origin: India</p>	<p>Powder Coated: EFB45BTBKTR EFB45BTGYTR EFB45BTBZTR</p> <p>Durable Finishes: EFB45BTAATR EFB45BTSBTR EFB45BTSNTR</p> 	<p>Flush Style Cover with Solid Lid – Low profile cover designed to attach to the EFB45S style floor boxes. Each cover is made of die cast aluminum and is equipped with a tamper-resistant screw to help keep out unauthorized personnel, a durable hinge which allows the cover to rotate open 180°, and two (2) slide egress doors that lock in the open position and automatically close around the cables when the cover is closed. The cover assemblies are designed to sit flush with the finished floors such as: carpet, tile, and wood. In order to make the cover assembly flush with the polished concrete or terrazzo floor the EFB45-CTR (concrete/terrazzo) ring must be used (ring sold separately). Available in the following powder coated finishes: black (BK), gray (GY), bronze (BZ), and durable finishes: brushed aluminum (AA), satin brass (SB), and satin nickel (SN).</p> <p>Country of Origin: India</p>
<p>NOTE: Depth of recess area in plate is 1/4" (6.35mm).</p>			

Evolution Series Floor Box Covers Ordering Information

Surface Style Cover

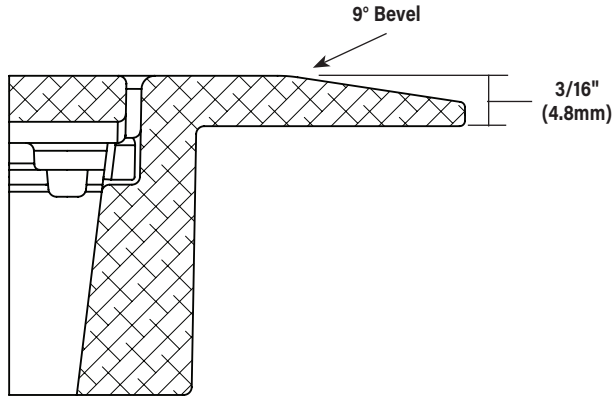

Flush Style Cover

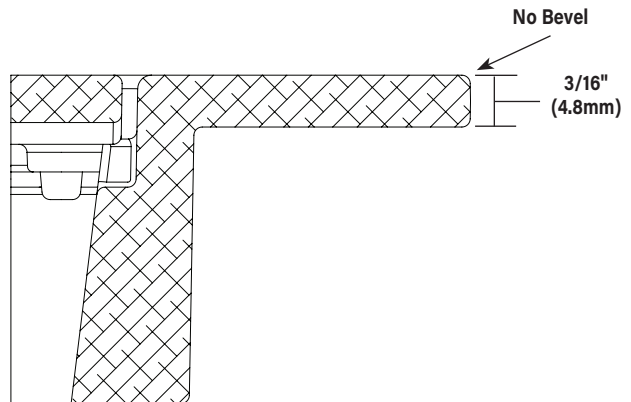

Catalog No./Item	Description/Specifications
EFB45-CTR	<p>Bare Concrete/Terrazzo Trim Ring – Nonmetallic ring for use with bare concrete and terrazzo floor applications.</p> <p>Country of Origin: USA</p> <p>NOTE: Ring must be attached to the floor box before pouring concrete or terrazzo.</p>

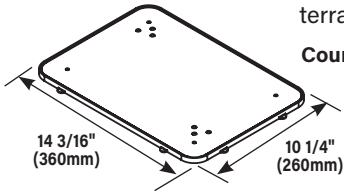

Catalog No./Item	Description/Specifications
EFB45-TEMPLATE	<p>Floor Box Template – Designed to help mark out floor to insure a proper fit.</p> <p>Country of Origin: USA</p>

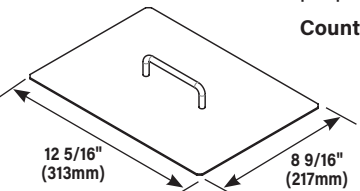

EFB45-TS	<p>Tile Shim – Used for floor coverings greater than 3/16" (4.7mm). The EFB45-TS allows the finished cover assembly to be flush with the finished floor. Includes one (1) 1/16" (1.6mm), one (1) 1/8" (3.2mm) and one 1/4" (6.4mm) tile shims for 7/16" (11.1mm) of upward adjustment.</p> <p>Country of Origin: USA</p>
-----------------	--

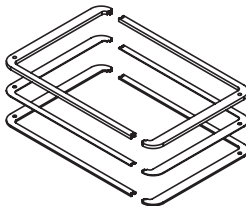
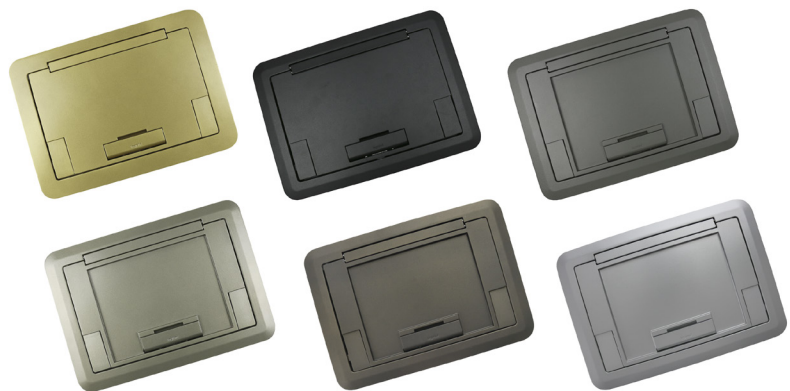
Evolution Series Floor Box covers are available in powder coated finishes of: black, gray, bronze, and durable finishes of: brushed aluminum, satin brass, and satin nickel.

NOTE: All brand and product names referenced in this document are registered trademarks or trademarks of their respective holders.



Legrand, North America
60 Woodlawn Street
West Hartford, CT 06110
1.877.BY.LEGRAND (295.3472)
www.legrand.us

Canada
1.800.723.5175 • 905.738.9195
www.legrand.ca

