



CRFB4 Series Floor Boxes can accept either Evolution™ Series Poke-Thru Covers or the new CRFB Series Floor Box Covers. CRFB2 Series Floor Boxes can accept the 6" Evolution™ Series Poke-Thru Covers.

Multi-Service Floor Boxes for Raised & Wood Floors

FloorSource Series™ CRFB Series™ Floor Boxes are round recessed floor boxes designed to meet the functionality and flexibility requirements of the raised and wood floor markets. CRFB Series Floor Boxes have multiple trade size KOs located on the sides and bottom of the box to feed separate compartments that can accommodate multiple combinations of power, communication, and audio/video services. The surface style covers (sold separately) are made from cast aluminum and are available in powder coat finishes of black, brass, nickel, bronze, gray and aluminum, as well as brushed aluminum, satin brass plated and satin nickel plates finishes.

CRFB Series Floor Boxes can also be field configured to accommodate power only, communication only, audio visual only, or combinations of all three services. CRFB Series Floor boxes applications include: open office environments, conference rooms, schools, stages, computer centers and altars.

Features & Benefits

- **Productivity**
 - Easy installation in a standard round diffuser opening, before or after the floor coverings, with locking tabs that secure it to the floor.
 - Prewired and custom plate options that reduce labor costs for field installations and increase contractor productivity.
- **Flexibility**
 - Multi-compartment boxes that can be field-configured or reconfigured for any combination of services.
 - Accepts a wide range of A/V devices for a seamless interface for voice, data and A/V applications at the point-of-use.
 - Compatible with raised and wood floors.
 - Accepts a wide range of conduit sizes.
- **TopGuard™ Protection.** Prevents water, dirt and debris from entering compartments.
- **Meets and exceeds all UL scrub water exclusion requirements for tile and carpet floors.**
- **Meets ADA Accessibility Guidelines.** Wide trim flange designed to meet the ADA Standard 4.5 for changes in the floor and ground service levels, plus beveled poke-thru trim flanges so the slope is no greater than 1:2 ratio.
- **Suitable for use in air handling spaces.** Meets NEC Section 300-22(C) and is suitable for use in air handling spaces and raise floor plenums.
- **UL listed.** Listed by Underwriters Laboratories Inc. to U.S. and Canadian safety standards for raised and wood floors.

Compliance



cULus Listed, Metal Outlet Boxes. File Number E2961. Guide QCIT/QCIT7.

CRFB2 Series Floor Box Assembly Details

The CRFB2 Series Floor Box housing is die-cast aluminum construction with stamped steel bottom plate.

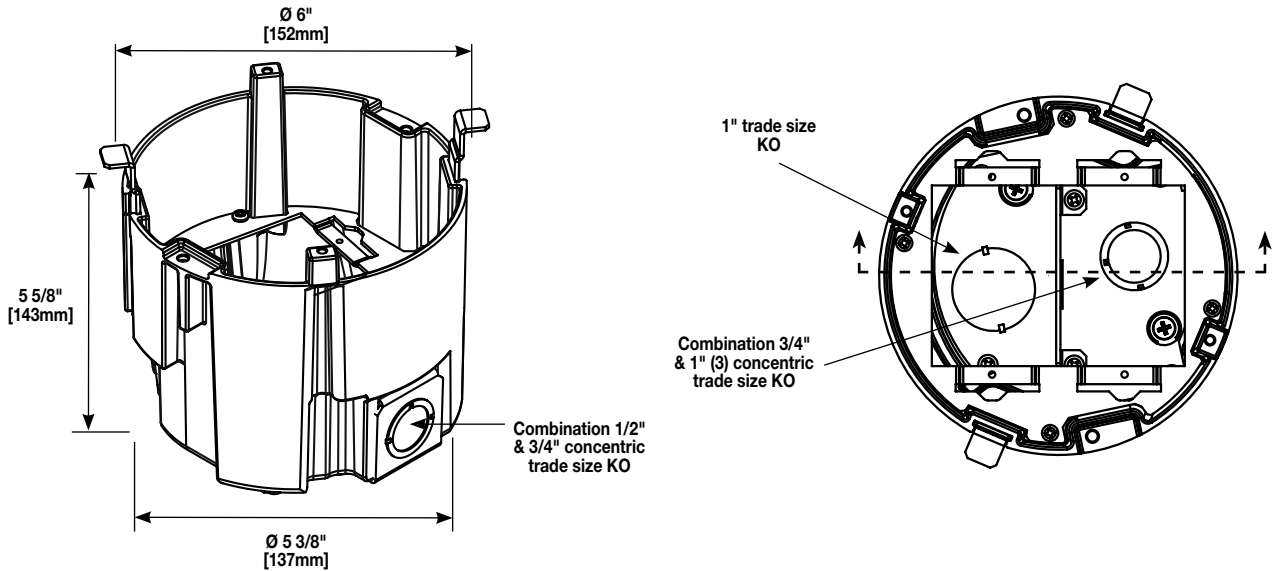

COMPARTMENT DEPTH

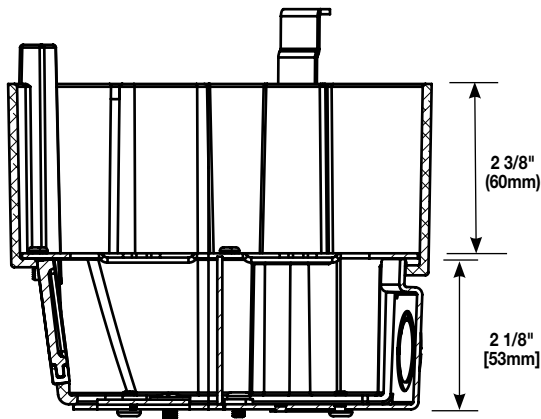

COMPARTMENT VOLUMES

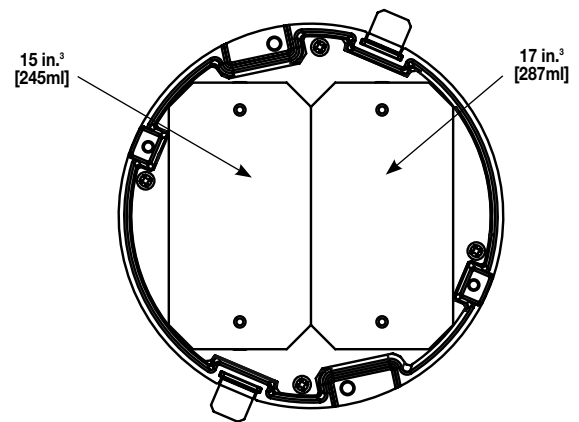

CRFB2 Series two-compartment configurable box.

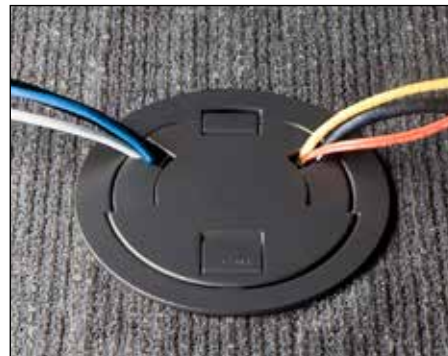

Cables egress from a CRFB2 Series Floor Box with Evolution Series Poke-Thru Cover.

CRFB2 Series Floor Box Ordering Information

CRFB2

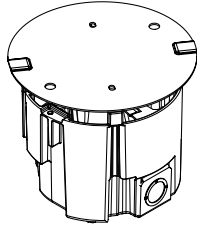

CRFB Housing – Die-cast aluminum construction with stamped steel bottom plate. Contains 2 gangs which utilize 8AT Series device plates. Includes divider for separating gangs.

Country of Origin: China

NOTE: Floor thickness range (including floor covering) 3/8" - 2" [9.5mm - 51mm].

- 6CTC2GY
- 6CTC2BK
- 6CTC2BS
- 6CTC2BZ
- 6CTC2NK
- 6CTC2AA
- 6CTC2SB
- 6CTC2SN

Surface Style Cover Assembly – Each cover is made from die-cast aluminum materials and equipped with a durable hinge which allows the cover to rotate open 180°, two (2) slide egress doors that lock in the open position and auto close around the cables when the covers are closed, an 8° beveled edge that meets ADA guidelines and reduces tripping hazards. These covers are designed to sit on top of the finished floor surface such as: carpet, tile and wood. Available in five (5) aesthetic powder coated finishes: black (BK), brass (BS), gray (GY), nickel (NK), bronze (BZ), and three (3) metal finishes: brushed aluminum (AA), satin brass plated (SB) and satin nickel plated (SN).

Country of Origin: India

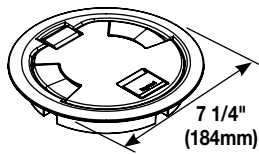

7 1/4"
(184mm)

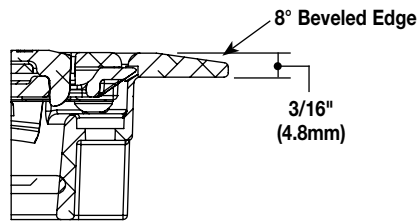

8° Beveled Edge

3/16"
(4.8mm)

NOTE: All surface style poke-thru devices come with a transition angle to aid in the change in floor elevation.

- 6CTC2GYTR
- 6CTC2BKTR
- 6CTC2BSTR
- 6CTC2BZTR
- 6CTC2NKTR
- 6CTC2AATR
- 6CTC2SBTR
- 6CTC2SNTR

Tamper-Resistant Surface Style Cover Assembly – Each cover is made from die-cast aluminum materials and equipped with a tamper-resistant screw to keep out unauthorized personnel, a durable hinge which allows the cover to rotate open 180°, two (2) slide egress doors that lock in the open position and auto close around the cables when the covers are closed, an 8° beveled edge that meets ADA guidelines and reduces tripping hazards. These covers are designed to sit on top of the finished floor surface such as: carpet, tile and wood. Available in five (5) aesthetic powder coated finishes: black (BK), brass (BS), gray (GY), nickel (NK), bronze (BZ), and three (3) metal finishes: brushed aluminum (AA), satin brass plated (SB) and satin nickel plated (SN).

Country of Origin: India

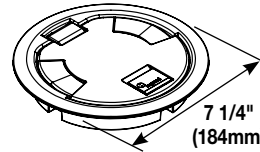

7 1/4"
(184mm)

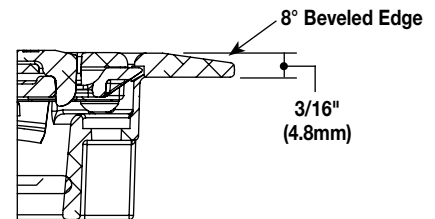

8° Beveled Edge

3/16"
(4.8mm)

NOTE: All surface style poke-thru devices come with a transition angle to aid in the change in floor elevation.

CRFB2 Series Floor Box Ordering Information

6CT2GY
6CT2BK
6CT2BS
6CT2BZ
6CT2NK
6CT2AA
6CT2SB
6CT2SN

Flush Style Cover Assembly –

Each cover is made from die-cast aluminum materials and equipped with a durable hinge which allows the cover to rotate open 180°, two (2) slide egress doors that lock in the open position and auto close around the cables when the covers are closed. These covers are designed to sit flush with the finished floor surface such as: carpet, tile, and wood. Available in five (5) aesthetic powder coated finishes: black (BK), brass (BS), gray (GY), nickel (NK), and bronze (BZ), and three (3) metal finishes: brushed aluminum (AA), satin brass plated (SB) and satin nickel plated (SN).

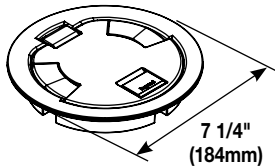

Country of Origin: India

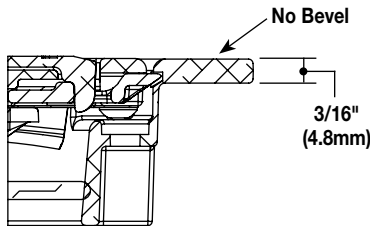

NOTE: Includes 6TS Tile Shim.

6CT2GYTR
6CT2BKTR
6CT2BSTR
6CT2BZTR
6CT2NKTR
6CT2AATR
6CT2SBTR
6CT2SNTR

Tamper-Resistant Flush Style Cover Assembly –

Each cover is made from die-cast aluminum materials and equipped with a tamper-resistant screw to keep out unauthorized personnel, a durable hinge which allows the cover to rotate open 180°, two (2) slide egress doors that lock in the open position and auto close around the cables when the covers are closed. These covers are designed to sit flush with the finished floor surface such as: carpet, tile, and wood. Available in five (5) aesthetic powder coated finishes: black (BK), brass (BS), gray (GY), nickel (NK), and bronze (BZ), and three (3) metal finishes: brushed aluminum (AA), satin brass plated (SB) and satin nickel plated (SN).

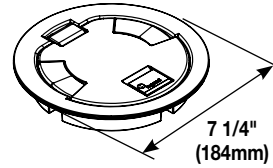

Country of Origin: India

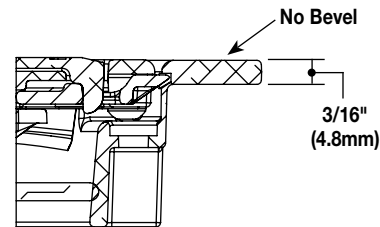

NOTE: Includes 6TS Tile Shim.

CRFB2 Series Floor Box Device Plates Ordering Information

8AT Center Mount Device Plate Mounting Locations

Mounting plates on this page can be installed in the shaded location indicated in this illustration.

NOTE: Device plates are not included with the CRFB2 Series Floor Box housing and must be purchased separately.

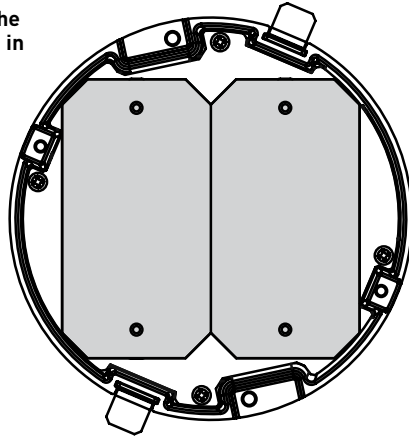

8B



Blank Device Plate – Single-gang device plate used to blank off either of the compartments, when no devices are used.

Country of Origin: USA

8DP

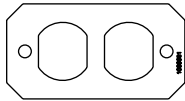

Duplex Device Plate – Single-gang device plate that accepts standard 20A duplex receptacle, a duplex Turnlok receptacle, fits in either of the compartments. Devices supplied by others.

Country of Origin: USA

8DEC

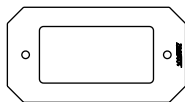

GFCI/Decorator Device Plate – Single-gang device plate that will accept Decorator style devices such as 20A receptacles, GFCIs, 106 adapters or A/V devices. Fits in either of the compartments. Devices supplied by others.

Country of Origin: USA

8ACT6A

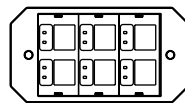

Communication Device Plate – Single-gang device plate that will accept up to six (6) ports of communication devices. Fits in either of the compartments. Devices supplied by others.

Country of Origin: USA

8MOS

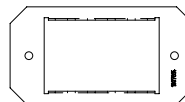

Mosaic Device Plate – Device plate accepts three (3) standard Mosaic devices (45mm x 22.5mm). Devices supplied by others.

Country of Origin: USA

NOTE: Not designed to accept adorne style devices.

8S1

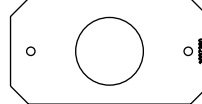

1 3/8" (35mm) Device Plate – Receptacle opening 1 3/8" (35mm). Accepts most 15A and 20A straight blade receptacles and 15A Turnlok receptacles.

Country of Origin: USA

8S2

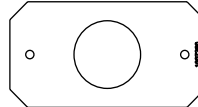

1 9/16" (40mm) Device Plate – Receptacle opening 1 9/16" (40mm). Accepts 20A Turnlok receptacles.

Country of Origin: USA

8TRAC

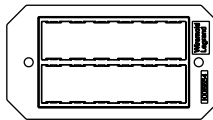

Ortronics TracJack Device Plate – Single-gang device plate that will accept up to six (6) Ortronics TracJack devices. Fits in either of the compartments. Devices supplied by others.

Country of Origin: USA

NOTE: When using 8TRAC or 8SER, remove side communications plug to avoid interference.

8SER

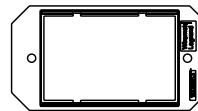

Ortronics Series II Device Plate – Single-gang device plate that will accept up to three (3) Ortronics Series II dual modular inserts. Fits in either of the compartments. Devices supplied by others.

Country of Origin: USA

NOTE: When using 8TRAC or 8SER, remove side communications plug to avoid interference.

8MAAP

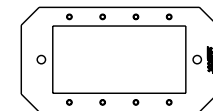

AVIP Device Plate – Single-gang device plate that will accept up to four (4) Legrand AVIP or Extron Electronics MAAP style plates. Fits in either of the compartments. Devices supplied by others.

Country of Origin: USA

8AAP

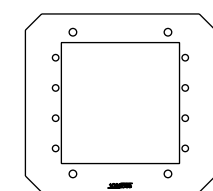

AAP Device Plate – Two-gang device plate that will accept up to four (4) Extron Electronics AAP style plates. 8AAP takes up both of the compartments. Devices supplied by others.

Country of Origin: USA

CRFB4 Series Floor Box Assembly Details

The CRFB4 Series Floor Box housing is die-cast aluminum construction with stamped steel bottom plate.

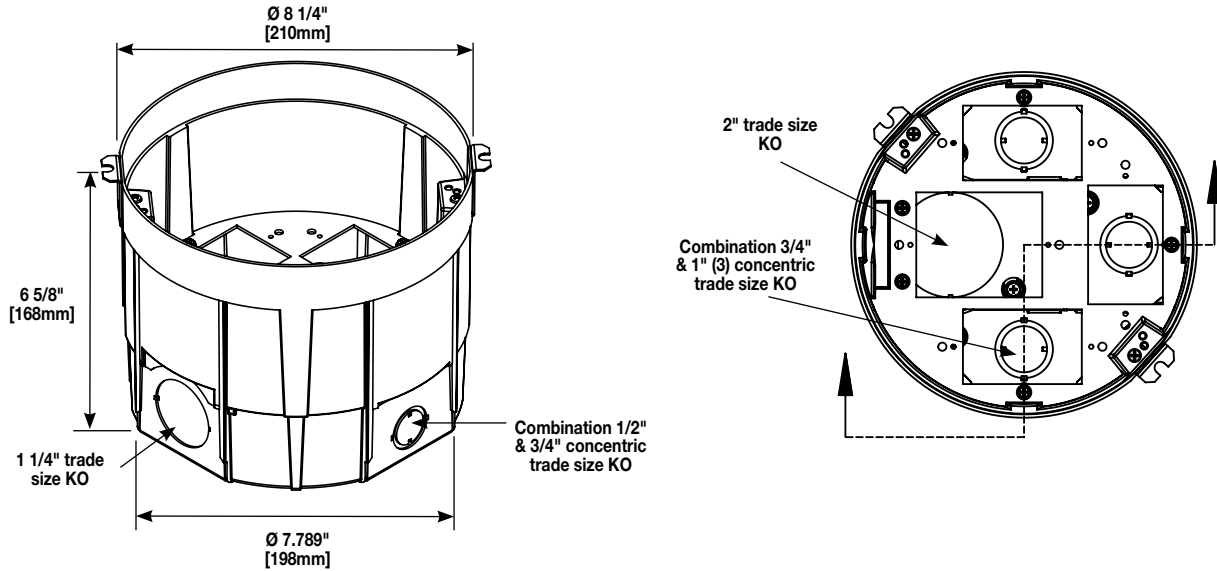

COMPARTMENT DEPTH

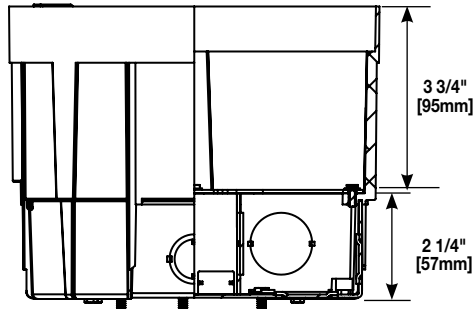

COMPARTMENT VOLUMES

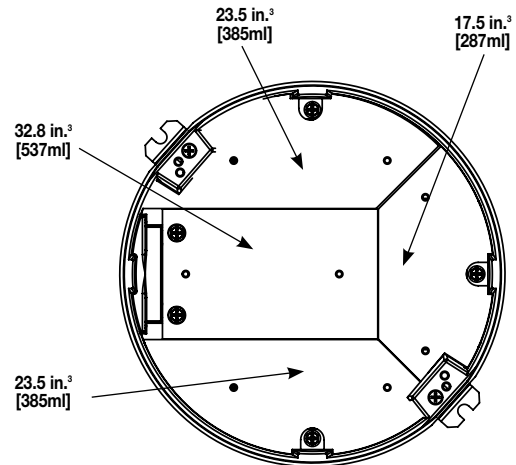

CRFB Series four-compartment configurable box.



New egress design for CRFB Series Floor Box Covers offers larger wire/cable egress with locking feature.



Cables egress from a CRFB Series Floor Box with Evolution Series Poke-Thru Cover.

CRFB4 Series Floor Box Ordering Information

CRFB4

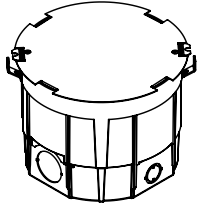

CRFB Housing – Die-cast aluminum construction with stamped steel bottom plate. Includes 3 duplex receptacle plates, 1 center communication plate and 3 cable pass through grommets for 1" trade size tunnel.

Country of Origin: China

NOTE: Floor thickness range (including floor covering) 3/8" - 2" [9.5mm - 51mm].

CRFBCTCBK CRFBCTCBS CRFBCTCNK CRFBCTCBZ CRFBCTCGY

Surface Style Cover Assembly with Carpet Insert – Available in die cast aluminum with a painted Black (BK), Brass (BS), Nickel (NK), Bronze (BZ) or Gray (GY) finish. Insert areas allow for tile or carpet cutouts to match finished floor.

Country of Origin: China

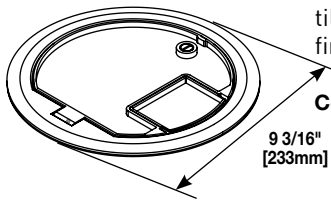

9 3/16"
[233mm]

CRFBBTCBK CRFBBTCBS CRFBBTCNK CRFBBTCBZ CRFBBTCGY

Surface Style Cover Assembly without Carpet Insert – Available in die cast aluminum with a painted Black (BK), Brass (BS), Nickel (NK), Bronze (BZ) or Gray (GY) finish. No cutouts are provided for floor coverings.

Country of Origin: China

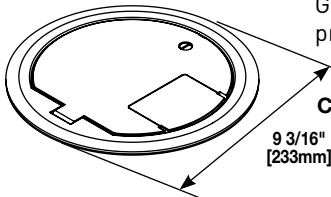

9 3/16"
[233mm]

CRFBCTCBKTR CRFBCTCBSTR CRFBCTCNKTR CRFBCTCBZTR CRFBCTCGYTR

Tamper-Resistant Surface Style Cover Assembly with Carpet Insert – Available in die cast aluminum with a painted Black (BK), Brass (BS), Nickel (NK), Bronze (BZ) or Gray (GY) finish. Lid has built-in key locking feature for tamper resistance. Insert areas allow for tile or carpet cutouts to match finished floor.

Country of Origin: China

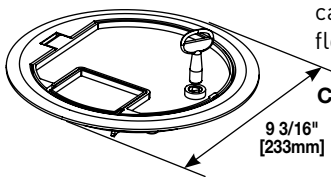

9 3/16"
[233mm]

CRFB-TUN

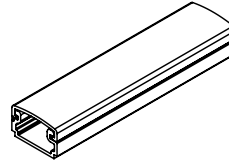

Tunnel – Tunnel allows the two outer compartments to be utilized for one service while the center two compartments are utilized for other services.

Country of Origin: China

CRFBBTCBKTR CRFBBTCBSTR CRFBBTCNKTR CRFBBTCBZTR CRFBBTCGYTR

Tamper-Resistant Surface Style Cover Assembly without Carpet Insert – Available in die cast aluminum with a painted Black (BK), Brass (BS), Nickel (NK), Bronze (BZ) or Gray (GY) finish. No cutouts are provided. Lid has built-in key locking feature for tamper resistance.

Country of Origin: China

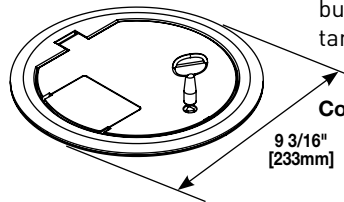

9 3/16"
[233mm]

8CTC2GY 8CTC2BK 8CTC2BS 8CTC2BZ 8CTC2NK 8CTC2AA 8CTC2SB 8CTC2SN

Surface Style Cover Assembly – Each cover is made from die-cast aluminum materials and equipped with a durable hinge which allows the cover to rotate open 180°, two (2) slide egress doors that lock in the open position and auto close around the cables when the covers are closed, an 8° beveled edge that meet ADA guidelines and reduces tripping hazards. These covers are designed to sit on top of the finished floor surfaces such as: carpet, tile and wood. Available in five (5) aesthetic powder coated finishes: black (BK), brass (BS), gray (GY), nickel (NK), and bronze (BZ), and three (3) metal finishes: brushed aluminum (AA), satin brass plated (SB) and satin nickel plated (SN).

Country of Origin: India

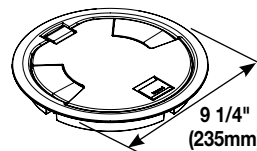

9 1/4"
(235mm)

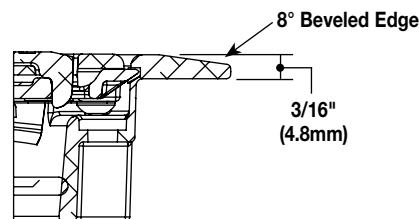

NOTE: All surface style poke-thru devices come with a transition angle to aid in the change in floor elevation.

CRFB4 Series Floor Box Ordering Information

8CTC2GYTR
8CTC2BKTR
8CTC2BSTR
8CTC2BZTR
8CTC2NKTR
8CTC2AATR
8CTC2SBTR
8CTC2SNTR

Tamper-Resistant Surface Style Cover Assembly – Each cover is made from die-cast aluminum materials and equipped with a tamper-resistant screw to keep out unauthorized personnel, a durable hinge which allows the cover to rotate open 180°, two (2) slide egress doors that lock in the open position and auto close around the cables when the covers are closed, an 8° beveled edge that meet ADA guidelines and reduces tripping hazards. These covers are designed to sit on top of the finished floor surfaces such as: carpet, tile and wood. Available in five (5) aesthetic powder coated finishes: black (BK), brass (BS), gray (GY), nickel (NK), and bronze (BZ), and three (3) metal finishes: brushed aluminum (AA), satin brass plated (SB) and satin nickle plated (SN).

Country of Origin: India

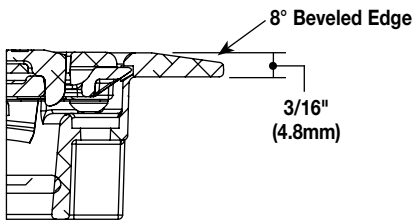
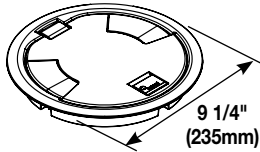

NOTE: All surface style poke-thru devices come with a transition angle to aid in the change in floor elevation.

8CT2GY
8CT2BK
8CT2BS
8CT2BZ
8CT2NK
8CT2AA
8CT2SB
8CT2SN

Flush Style Cover Assembly – Each cover is made from die-cast aluminum materials and equipped with a durable hinge which allows the cover to rotate open 180°, two (2) slide egress doors that lock in the open position and auto close around the cables when the covers are closed. These covers are designed to sit flush with the finished floor surfaces such as: carpet, tile, and wood. Available in five (5) aesthetic powder coated finishes: black (BK), brass (BS), gray (GY), nickel (NK), and bronze (BZ), and three (3) metal finishes: brushed aluminum (AA), satin brass plated (SB) and satin nickle plated (SN).

Country of Origin: India

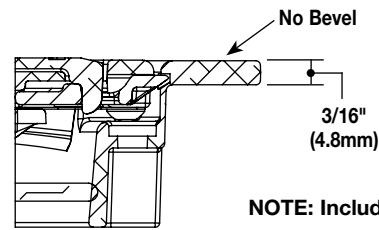
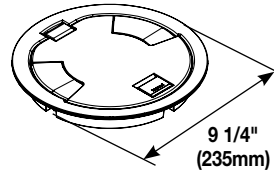

NOTE: Includes 8TS Tile Shim.

8CT2GYTR
8CT2BKTR
8CT2BSTR
8CT2BZTR
8CT2NKTR
8CT2AATR
8CT2SBTR
8CT2SNTR

Tamper-Resistant Flush Style Cover Assembly – Each cover is made from die-cast aluminum materials and equipped with a tamper-resistant screw to keep out unauthorized personnel, a durable hinge which allows the cover to rotate open 180°, two (2) slide egress doors that lock in the open position and auto close around the cables when the covers are closed. These covers are designed to sit flush with the finished floor surfaces such as: carpet, tile, and wood. Available in five (5) aesthetic powder coated finishes: black (BK), brass (BS), gray (GY), nickel (NK), and bronze (BZ), and three (3) metal finishes: brushed aluminum (AA), satin brass plated (SB) and satin nickle plated (SN).

Country of Origin: India

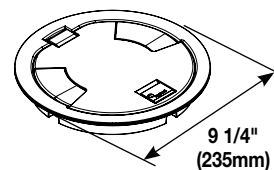

NOTE: Includes 8TS Tile Shim.

CRFB4 Series Floor Box Device Plates for Location 1 Ordering Information

Device Plate Location #1

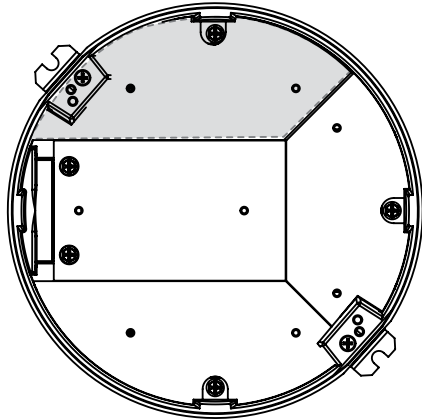

NOTE: Standard sizes for device plates for Plate Location 1 are 6 11/32" [161mm] x 2 3/4" [62mm].

NOTE: Duplex Device Plate (CRFB-D-1) is included with the CRFB4 Series Floor Box housing. Other Device Plates must be purchased separately.

CRFB-B-1



Blank Device Plate #1 – Used to close off unused gang.
Country of Origin: USA

CRFB-D-1

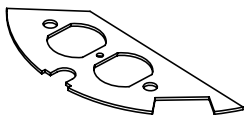

Duplex Device Plate – Accepts standard 15A and 20A Duplex Receptacles.
Country of Origin: USA

CRFB-GFI-1

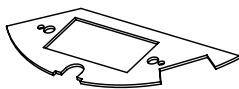

GFCI/Decorator Device Plate – Accepts standard GFCI or Decorator Style Receptacles.
Country of Origin: USA

CRFB-SR1-1

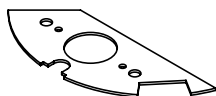

1.39" (35mm) Device Plate – Accepts single device 1.39" (35mm). Accepts most 15A and 20A straight blade receptacles and 15A Turnlok receptacles.
Country of Origin: USA

CRFB-AB-1

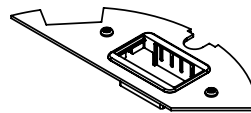

Communication Device Plate – Accepts two (2) ports of communication devices. Includes one (1) Wiremold CM Series Open System adapter and inserts.
Country of Origin: USA

CRFB-RT-1

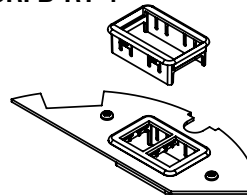

Communication Device Plate – Accepts two (2) ports of communication devices. Includes one (1) Ortronics® Series II and one (1) TracJack adapter.
Country of Origin: USA

CRFB4 Series Floor Box Device Plates for Location 2 Ordering Information

Device Plate Location #2

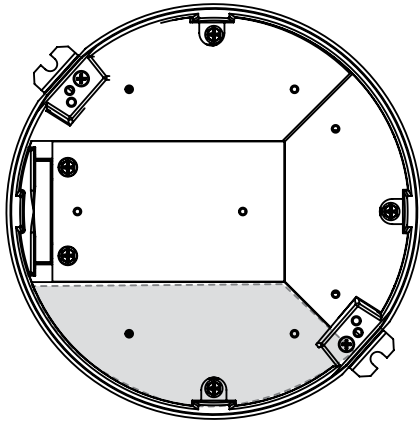

NOTE: Standard sizes for device plates for Plate Location 2 are 5 7/32" [132mm] x 2 3/4" [62mm].

NOTE: Duplex Device Plate (CRFB-D-2) is included with the CRFB4 Series Floor Box housing. Other Device Plates must be purchased separately.

CRFB-B-2

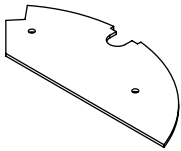

Blank Device Plate #2 – Used to close off unused gang.
Country of Origin: USA

CRFB-D-2

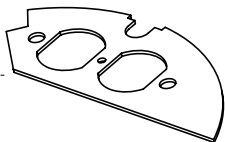

Duplex Device Plate – Accepts standard 15A and 20A Duplex Receptacles.
Country of Origin: USA

CRFB-GFI-2

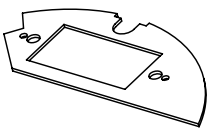

GFCI/Decorator Device Plate – Accepts standard GFCI or Decorator Style Receptacles.
Country of Origin: USA

CRFB-SR1-2

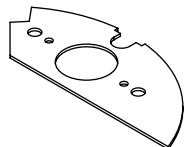

1.39" (35mm) Device Plate – Accepts single device 1.39" [35mm]. Accepts most 15A and 20A straight blade receptacles and 15A Turnlok receptacles.
Country of Origin: USA

CRFB-SR2-2

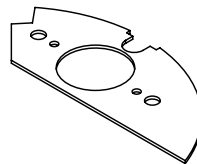

1.6" (41mm) Device Plate – Accepts single device 1.6" [41mm]. Accepts most 20A and 30A Turnlok receptacles.
Country of Origin: USA

NOTE: When using a 30A device, egress opening must be located directly over receptacle.

CRFB-AB-2

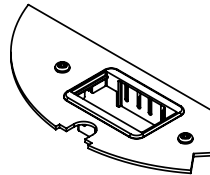

Communication Device Plate – Accepts two (2) ports of communication devices. Includes one (1) Wiremold CM Series Open System adapter and inserts.
Country of Origin: USA

CRFB-RT-2

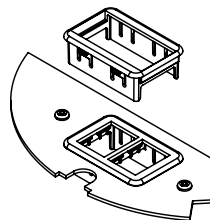

Communication Device Plate – Accepts two (2) ports of communication devices. Includes one (1) Ortronics® Series II and one (1) TracJack adapter.
Country of Origin: USA

CRFB4 Series Floor Box Device Plates for Location 3 Ordering Information

Device Plate Location #3

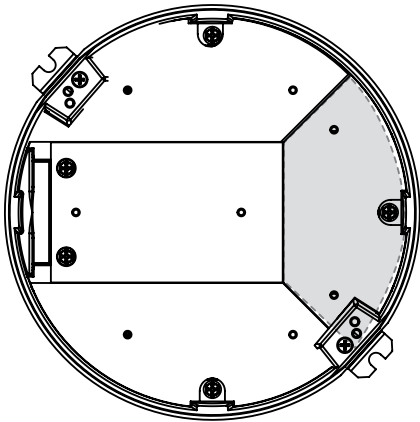

NOTE: Standard sizes for device plates for Plate Location 3 are 5 7/32" [132mm] x 2 3/4" [62mm].

NOTE: Duplex Device Plate (CRFB-D-3) is included with the CRFB4 Series Floor Box housing. Other Device Plates must be purchased separately.

CRFB-B-3

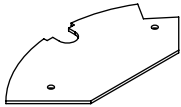

Blank Device Plate #3 – Used to close off unused gang.

Country of Origin: USA

CRFB-D-3

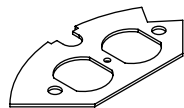

Duplex Device Plate – Accepts standard 15A and 20A Duplex Receptacles.

Country of Origin: USA

CRFB-GFI-3

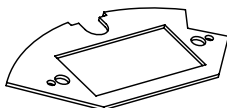

GFCI/Decorator Device Plate – Accepts standard GFCI or Decorator Style Receptacles.

Country of Origin: USA

CRFB-SR1-3

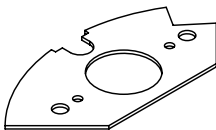

1.39" (35mm) Device Plate – Accepts single device 1.39" (35mm). Accepts most 15A and 20A straight blade receptacles and 15A Turnlok receptacles.

Country of Origin: USA

CRFB-AB-3

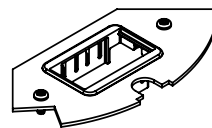

Communication Device Plate –

Accepts two (2) ports of communication devices. Includes one (1) Wiremold CM Series Open System adapter and inserts.

Country of Origin: USA

CRFB-RT-3

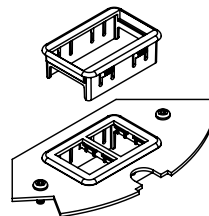

Communication Device Plate –

Accepts two (2) ports of communication devices. Includes one (1) Ortronics® Series II and one (1) TracJack adapter.

Country of Origin: USA

CRFB4 Series Floor Box Device Plates for Location 4 Ordering Information

Device Plate Location #4

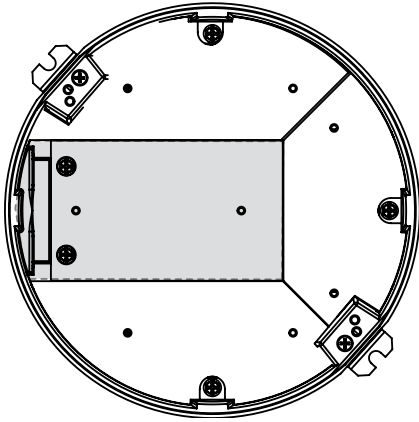

NOTE: Standard sizes for device plates for Plate Location 4 are 5 7/32" [132mm] x 2 3/4" [62mm].

NOTE: Center Communication Device Plate (CRFB-6COM-4) is included with the CRFB4 Series Floor Box housing. Other Device Plates must be purchased separately.

CRFB-BEZ6A-4

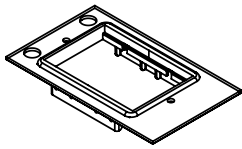

Center 6A Comm Bezel – 6A communications plate. Includes: one (1) 6A Wiremold Open System Bezel, one (1) Ortronics® Series II Bezel, one (1) Ortronics® TracJack Bezel. Modular jacks sold separately.

Country of Origin: USA

CRFB-B-4

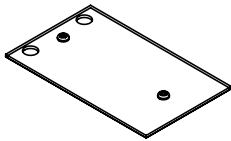

Center Blank Device Plate #4 – Used to close off unused gang.

Country of Origin: USA

CRFB-D-4

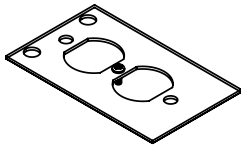

Center Duplex Device Plate – Accepts standard 15A and 20A Duplex Receptacles.

Country of Origin: USA

CRFB-GFI-4

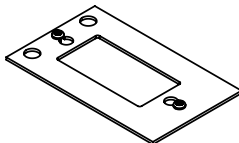

Center GFCI/Decorator Device Plate – Accepts standard GFCI or Decorator Style Receptacles.

Country of Origin: USA

CRFB-SR1-4

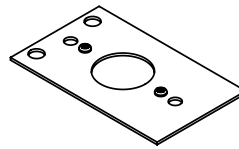

Center 1.39" (35mm) Device Plate – Accepts single device 1.39" (35mm). Accepts most 15A and 20A straight blade receptacles and 15A Turnlok receptacles.

Country of Origin: USA

CRFB-MAAP-4

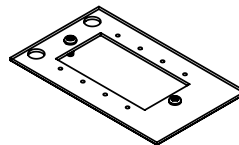

Center AVIP Plate – Accepts up to four (4) Legrand AVIP or Extron® Electronics MAAP style device plates. Devices sold separately.

Country of Origin: USA

CRFB-6COM-4

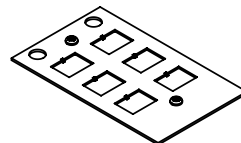

Center Communication Device Plate – Communications plate with six (6) RJ knockouts. Modular keystone jacks sold separately.

Country of Origin: USA

Vertical Markets

- Commercial
- Hospitality
- Education
- Entertainment
- Retail
- Transit

NOTE: All brand and product names referenced in this document are registered trademarks or trademarks of their respective holders.

 **NOTE:** The paper used to print this document is an environmentally responsible paper with 10% post consumer waste, with FSC and SFI Chain of Custody certifications, Lacey Act compliant. 100% of the electricity used to manufacture Flo sheets is generated with Green-e certified renewable energy.



Legrand, North America
60 Woodlawn Street
West Hartford, CT 06110
1.877.BY.LEGRAND (295.3472)
www.legrand.us

Canada
905.738.9195
www.legrand.ca

FOLLOW US

