

RC7 Series

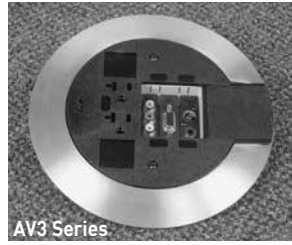

AV3 Series



RC4 Series



AMD8 Series

Bring Power & Communication Services Directly to the Workstation

Flush Style Poke-Thru Devices are an excellent solution for bringing power, communication, and A/V services to the workstation in an open space, above-grade floor environment. All Wiremold Flush Style Poke-Thru Devices come with built-in TopGuard™ protection, an industry-leading design that meets and exceeds UL scrub water exclusion requirements for tile and carpet floors. Topguard protection prevents water, dirt, or debris from entering not just the power devices, but also the communication devices.

All Wiremold Flush Style Poke-Thru Devices can be installed on tile, carpet, or wood covered floors. Each of these devices provides an excellent solution for both new or retrofit construction, with typical applications that include office buildings, airports, malls, shopping centers, libraries, and schools.

Features & Benefits

- **AV3 Series is specifically designed to meet the growing needs of the audio and video market.** AV3 Series accepts Legrand AVIP devices and Extron® MAAP Series mini architectural adapter plates. (Extron devices sold separately only through authorized Extron dealers.)
- **Multiple service capability.** RC7, AV3, and RC4 Series provide power and communication services. The AV3 and RC4 Series provide for use of flush or recessed fiber optic devices. Eliminates the cost of a second poke-thru to accommodate additional services.
- **Fire rated for up to 2-hour rated floors.** Maintains the fire classification of the floor.
- **Provides flexibility with a single poke-thru unit.** 20A duplex receptacle in the AV3, and the RC7 Series can be wired as standard or isolated ground receptacle. Two 20A duplex power receptacles in the RC4 Series are wired with a 6-wire system with individual neutral and ground wires, and can be wired for standard or isolated ground. RC9 quad 15A receptacle can also be wired as standard or isolated ground receptacle.
- **Individual slide covers.** Protects power and communication devices. Power slide covers snap back into place when receptacle is not in use. Activate either power or communication services, simultaneously or individually. RC9AMD and AMD8 Series Poke-Thru Devices are the only all communication poke-thru devices available with slide cover protection.
- **TopGuard Protection.** Integral design component that prevents water, dirt and debris from entering power and communication compartments. Whenever you see the TopGuard protection icon on any Wiremold product, you'll know it meets and exceeds UL scrub water exclusion requirements for tile and carpet floors.
- **Prepour Sleeve.** Creates a cast-in-place core hole that allows the contractor to position poke-thru units before concrete is poured. Eliminates the cost and labor of coring the opening.
- **Datacom connectivity options.** Accepts industry standard and proprietary devices from a wide range of manufacturers to provide a seamless and aesthetically pleasing interface for voice, data, audio, and video applications at the point-of-use.
- **"Step-on-it" installation.** Quick and easy installation without the need for additional fasteners or a second installer.
- **Suitable for use in air handling plenums.** In accordance with Sec 300-22(C) of the National Electrical Code.
- **Meets ADA Accessibility Guidelines.** Wide trim flange on the product is designed to meet the ADA Accessibility Guidelines as it pertains to ADA Standard 4.5 which addresses changes in floor and ground surface levels. The poke-thru trim flanges are beveled so the slope is no greater than 1:2 ratio.
- **UL Listed & UL Fire Classified to U.S. and Canadian safety standards for tile, terrazzo, carpet and wood covered floors.**

Vertical Markets

- Commercial
- Education
- Healthcare
- Hospitality
- Entertainment
- Retail



Download this product's PEP ecopassport environmental product declaration at www.legrand.us/resources-and-downloads. This declaration conforms with ISO 14025 and 14040 and is in alignment with EN 15804.

Compliance



cULus Listed, Metallic Outlet Box File Number E2961. Guide QCIT.
cULus Listed Nonmetallic Outlet Boxes & Fittings Classified for Fire Resistance: File R8209, Guide CEYY. Meets Article 300.21, 300.22(C) & 314 of NEC.



Protection from water, dirt, and debris.

Flush Poke-Thru Device Specifications

3" Diameter Hole		RC7 Series	RC9 Series	RC9AMD Series
POKE-THRU SERIES				
HOLE SIZE		Minimum: 3 1/16" (78mm) Maximum: 3 1/8" (79mm)	Minimum: 3 1/16" (78mm) Maximum: 3 1/8" (79mm)	Minimum: 3 1/16" (78mm) Maximum: 3 1/8" (79mm)
UL FIRE CLASSIFICATION		1-, 1 1/2- & 2-hrs	1-, 1 1/2- & 2-hrs	1-, 1 1/2- & 2-hrs
UL SCRUBWATER PROTECTION		TopGuard™	TopGuard™	TopGuard™
CAPACITY		2 Gangs (1) 20A Duplex Receptacle, (2) Ports of Communication Devices	2 Gangs (1) 15A Quad Receptacle, (2) Openings for Communication Pass-Through	2 Gangs (4) Ports of Communication Devices
MAXIMUM COPPER FILL	POWER*	(3) #12 AWG .01536 Sq. in. (9.91 sq. mm)	(3) #12 AWG .01536 Sq. in. (9.91 sq. mm)	N/A
	COMMUNICATIONS*	(1) Cat 6A/Channel .004 Sq. in. (2.58 sq. mm)	(1) Cat 6A/Channel .004 Sq. in. (2.58 sq. mm)	(4) Cat 6A/Channel .01600 Sq. in. (10.324 sq. mm)
FEED CHANNELS	POWER	3/4" Trade Size	3/4" Trade Size	N/A
	COMMUNICATIONS	1/2" Trade Size/Channel (2) Channels per unit	1/2" Trade Size/Channel (2) Channels per unit	2" Trade Size
COVER SIZE		7" (178mm)	7" (178mm)	7" (178mm)
COVER COLORS		Black, Brass, Aluminum, Gray	Black, Brass, Aluminum, Gray	Black, Brass, Aluminum, Gray
APPROVED CONCRETE FLOOR COVERINGS		Carpet, Tile & Wood	Carpet, Tile & Wood	Carpet, Tile & Wood
FLOOR COVERING THICKNESS		Minimum: 1/8" (3.2mm) Maximum: 3/4" (19.1mm)	Minimum: 1/8" (3.2mm) Maximum: 3/4" (19.1mm)	Minimum: 1/8" (3.2mm) Maximum: 3/4" (19.1mm)

4" Diameter Hole		AV3 Series	AMD8 Series	RC4 Series	RC3 Series
POKE-THRU SERIES					
HOLE SIZE		Minimum: 4" (102mm) Maximum: 4 1/8" (105mm)	Minimum: 4" (102mm) Maximum: 4 1/8" (105mm)	Minimum: 4" (102mm) Maximum: 4 1/8" (105mm)	Minimum: 4" (102mm) Maximum: 4 1/8" (105mm)
UL FIRE CLASSIFICATION		1-, 1 1/2- & 2-hrs	1-, 1 1/2- & 2-hrs	1-, 1 1/2- & 2-hrs	1-, 1 1/2- & 2-hrs
UL SCRUBWATER PROTECTION		TopGuard™	TopGuard™	TopGuard™	TopGuard™
CAPACITY		2 Gangs (1) 20A Duplex Receptacle, (3) Single Width Extron MAAP Devices or (4) Ports of Communications	1 Gang All Communications, (8) Ports for Communication Devices	2 Gangs (2) 20A Duplex Receptacles, and (4) ports of Communication Devices	2 Gangs (1) 20A Duplex Receptacle, and (4) Ports for Communication devices
MAXIMUM COPPER FILL	POWER*	(3) #12 AWG .01536 Sq. in. (9.91 sq. mm)	N/A	(6) #12 AWG .03072 Sq. in. (19.82 sq. mm)	(3) #12 AWG .01536 Sq. in. (9.91 sq. mm)
	COMMUNICATIONS*	(6) Cat 6A/Channel .01938 Sq. in. (12.503 sq. mm)	(10) Cat 6A/Channel .03474 Sq. in. (22.412 sq. mm)	(2) Cat 6/Channel .008 Sq. in. (5.16 sq. mm)	(2) Cat 6/Channel .008 Sq. in. (5.16 sq. mm)
FEED CHANNELS	POWER	3/4" Trade Size	N/A	3/4" Trade Size	3/4" Trade Size
	COMMUNICATIONS	1 1/4" Trade Size/Channel	3/4" & 1 1/4" Trade Size/Channel	3/4" Trade Size (Equivalent) Oval Shaped Opening	3/4" Trade Size (Equivalent) Oval Shaped Opening
COVER SIZE		8 1/4" (210mm)	8 1/4" (210mm)	8 1/4" (210mm)	7 1/2" (191mm)
COVER COLORS		Black, Brass, Aluminum, Gray	Black, Brass, Aluminum, Gray	Black, Brass, Aluminum, Gray	Black, Brass, Aluminum, Gray
APPROVED CONCRETE FLOOR COVERINGS		Carpet, Tile & Wood	Carpet, Tile & Wood	Carpet, Tile & Wood	Carpet, Tile & Wood
FLOOR COVERING THICKNESS		Minimum: 1/8" (3.2mm) Maximum: 3/4" (19.1mm)	Minimum: 1/8" (3.2mm) Maximum: 3/4" (19.1mm)	Minimum: 1/8" (3.2mm) Maximum: 3/4" (19.1mm)	Minimum: 1/8" (3.2mm) Maximum: 3/4" (19.1mm)

* The above maximum copper fill values are the maximum amount of copper to maintain fire classification and are for each individual power and communication compartments. Do not add values together for any one compartment.

Flush Poke-Thru Devices Specifications

Copper Cross Section:

The copper cross-sectional area determines the amount of wire fill capacity in a poke-thru device. Unlike other wire and cable management systems that utilize wire fill capacity, a poke-thru device is UL tested under fire conditions to determine the maximum amount of copper conductors that will pass through a poke-thru device, while maintaining the fire-rating of the floor assembly. All Walker Flush Style Devices are UL Classified to U.S. and Canadian safety standards.

Copper Cross Sectional Area of Commonly Used Conductors		
Size	Solid	
#24	.00032 sq. in.	(.206mm ²)
#23	.00040 sq. in.	(.258mm ²)
#22	.00050 sq. in.	(.322mm ²)
#14	.00323 sq. in.	(2.083mm ²)
#12	.00512 sq. in.	(3.303mm ²)
#10	.00815 sq. in.	(5.258mm ²)
# 8	.01296 sq. in.	(8.361mm ²)

NOTE: Use above values for solid or stranded conductors.

Concrete Thickness Min:

- 1-HOUR RATED FLOOR – 2 1/4" (57mm) min over top of deck (or 3" (76mm) thick reinforced concrete slab)
- 2-HOUR RATED FLOOR – 3 1/4" (83mm) min over top of deck (or 4" (102mm) thick reinforced concrete slab)

Floor Coverings:

The poke-thru device is fire rated for carpet and wood covered concrete floors, and tile floor coverings 1/8" to 3/4" (3.2mm to 19.1mm) thickness. For floor coverings not listed above, consult factory.

Combined Thickness

A combined concrete and floor covering thickness of greater than 8-1/2" requires custom solutions to maintain access to junction boxes

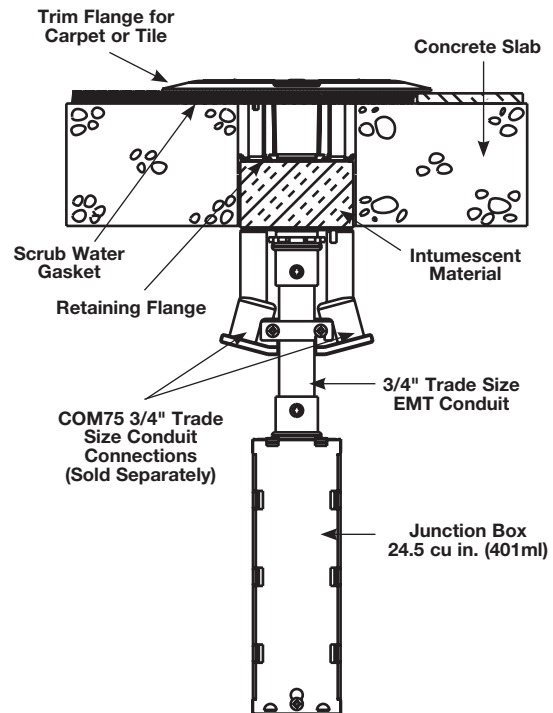

CAUTION: These devices are suitable for 1, 1 1/2, and 2 hour rated floor assemblies as described in the UL Fire Resistance directory for each service. These devices meet all UL scrub water requirements, but are not suitable for wet or damp locations, or other areas subject to saturation with water or other liquids such as commercial kitchens.

Download this product's PEP ecopassport® environmental product declaration at www.legrand.us/resources-and-downloads. This declaration conforms with ISO 14025 and 14040 and is in alignment with EN 15804.

Poke-Thru Devices and abandonment fitting are for use with 1-, 1 1/2-, or 2-hour rated unprotected reinforced concrete floor and 1-, 1 1/2- or 2-hour rated floors employing unprotected steel floor units and concrete topping (D900-Series Designs), or concrete floors with suspended ceilings. (Fire resistive designs with suspended ceilings should have provisions for accessibility in the ceiling area below the Poke-Thru Fittings). The assembled Poke-Thru stem and service fitting or the abandonment fittings will not reduce the ratings of the floor assembly when the thickness and type of concrete (required for the specific rating) are within the specified limits and the fittings are installed as specified:

- 1. Spacing** – Minimum of 2' (610mm) OC and not more than one unit per 65 square feet (6 square meters) of floor area in each span.
- 2. Concrete** – Minimum thickness of structural concrete topping of 2 1/4" (57mm) over metal deck or a minimum 3" thick reinforced concrete slab. Unit weight of concrete to be 110 to 155 pcf.
- 3. Installation** – Mounted in a 4" (102mm) diameter core drilled hole in concrete per installation instructions accompanying the fittings or abandonment fittings. For use with power circuits, data and/or telephone cables as tabulated below.

NOTE: The material that is used in Wiremold® Poke-Thru devices is not listed under the directory for Fire Stopping Material because the poke-thru device is UL Classified as "Outlet Boxes and Fittings Classified For Fire Resistance (CEYY)". The pass/fail criteria comes from UL263. The pass criteria is that the poke-thru unit cannot exceed 325° F. above ambient before the concrete slab (or deck) reaches this same temperature. Some poke-thru devices are tested for 2 hours while others are tested for 4 hours. The intumescent material has never been tested as a fire-stopping material as a stand-alone device. This material is designed to work as a unit with the entire poke-thru device.

3 1/16" HOLE SIZE POKE-THRU DEVICES

RC7 Series Poke-Thru Devices Ordering Information

Catalog No./Item Description/Specifications

RC7STC

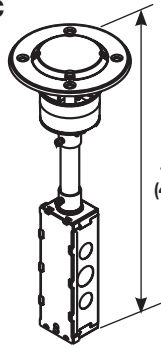

Insert Assembly with Disposable Plate – Use with RC7C Series Covers to complete installation.

Country of Origin: Mexico

RC7CTCGY*
RC7CTCBK*
RC7CTCAL*
RC7CTCBS*
RC7CTCAB*
RC7CTCAA*

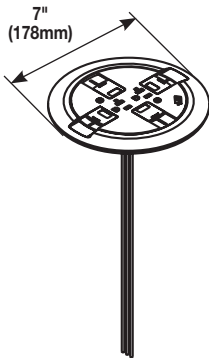

Finish Flange and Slide Holder Assembly – Prewired 20A duplex can be wired as standard duplex or isolated ground. Wiremold Open System unloaded inserts to accept two discrete keystone connectors from most manufacturers are provided. Includes 2 Cat 6 TechChoice™ discrete keystone connectors and Ortronics® TracJack adapters.

Country of Origin: Mexico

CAUTION: Not intended for use on polished concrete or terrazzo floor applications.

RC7KTCGY*
RC7KTCBK*
RC7KTCAL*
RC7KTCBS*

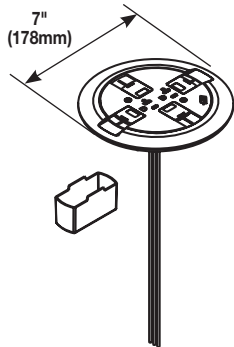

Retrofit Kit – Used to upgrade existing installations of RC7 Poke-Thru Devices on carpet floors to meet scrub water requirements. Includes 20A duplex receptacle that can be wired as a standard duplex or isolated ground, two Category 6 TechChoice™ discrete keystone connectors, and two Ortronics TracJack mounting bezels. Also includes scrub water finish flange and slide holder assembly. Kit also includes duplex receptacle barrier. Old barrier must be replaced with new. See installation instructions with retrofit kit for complete installation details.

Country of Origin: Mexico

Catalog No./Item Description/Specifications

Catalog Number Explanation RC7ATCAL			
RC7	A	TC	AL
Identifies Poke-Thru Series	Identifies Assembled Unit (A) or Cover (C)	Identifies that Unit is approved for Tile and Carpet Floors	Identifies Color of Cover Assembly (See below)

RC7ATCGY*
RC7ATCBK*
RC7ATCAL*
RC7ATCBS*
RC7ATCAB*
RC7ATCAA*

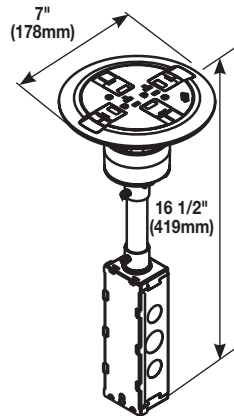

Assembled Unit – Prewired 20A duplex receptacle can be wired as standard duplex or isolated ground. Wiremold Open System unloaded inserts to accept two discrete keystone connectors from most manufacturers are provided. Includes 2 Cat 6 TechChoice™ discrete keystone connectors and Ortronics® TracJack bezels.

Country of Origin: Mexico

CAUTION: Not intended for use on polished concrete or terrazzo floor applications.

RC7SHTCBK
RC7SHTCGY
RC7SHTCBS

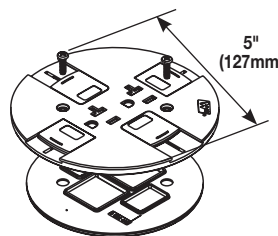

Nonmetallic Slide Holder Assembly – Available in black (RC7SHTCBK), gray (RC7SHTCGY) and nonmetallic brass (RC7SHTCBS).

Country of Origin: Mexico

NOTE: Assembled with scrub water gasket. For use on tile or carpet floors.

* Poke-Thru Devices on this page are available in some or all of the following cover color options as indicated by the part numbers:

- GY – Gray painted flange with gray nonmetallic cover,
- BK – Black painted flange with black nonmetallic cover,
- AL – Brushed Aluminum flange with black nonmetallic cover
- BS – Brushed Brass flange with black nonmetallic cover
- AA – Brushed Aluminum flange with aluminum-colored nonmetallic cover
- AB – Brushed Brass flange with brass-colored nonmetallic cover

Where applicable, slide covers match the cover color.

NOTE: See page 3 for specifications.

3 1/16" HOLE SIZE POKE-THRU DEVICES

RC7 Series Poke-Thru Devices Ordering Information

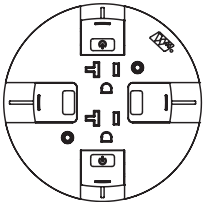
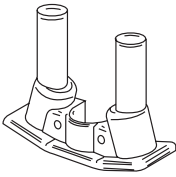
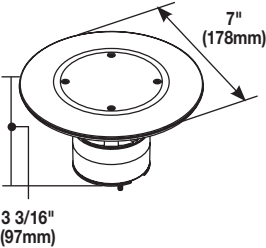
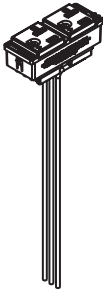
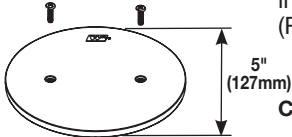
Catalog No./Item	Description/Specifications	Catalog No./Item	Description/Specifications		
RC7SHTCBKCR RC7SHTCGYCR RC7SHTCBSCR RC7SHTCAACR	<p>Poke-Thru Controlled Receptacle – Nonmetallic Slide Holder Assembly with Controlled Receptacle Markings. Markings are located in a recess pad and are permanent indicating the duplex receptacle below has been wired up to comply with 2014 NEC®, CA Title 24 and ASHRAE Energy Efficiency Standard 90.1. Available in black (RC7SHTCBKCR), gray (RC7SHTCGYCR), brass (RC7SHTCBSCR) and aluminum (RC7SHTCAACR). Slide holder to be used with RC7ATC and RC7CTC units.</p> <p>Country of Origin: Mexico</p>		COM50 COM75	<p>Communication Adapter – For two 1/2" trade size conduit connections (COM50). For two 3/4" trade size conduit connections (COM75).</p> <p>Country of Origin: Mexico</p> <p>NOTE: No additional capacity with COM75.</p> <p>Max concrete thickness of 7.5" when COM50/COM75 is used</p>	
ABPLUG	<p>Abandonment Plug Assembly – Complete plug assembly for abandoning an open 3" (76mm) cored-hole. Assembly includes intumescent fire-stop material to maintain the fire-classification of the floor, integral retainer ring to prevent the unit from pulling up through the floor, and a black die-cast aluminum cover.</p> <p>Country of Origin: Mexico</p>		RC37REC RC37REC-25	<p>Replacement Receptacle – Prewired snap-in 20A receptacle can be wired as standard duplex or isolated ground. Available only in black. See installation instructions with replacement receptacle for complete installation details. The RC37REC-25 is available with 25 foot leads and can be wired as standard duplex or isolated ground.</p> <p>Country of Origin: Mexico</p> <p>NOTE: The 20A duplex receptacle supplied with the new scrub water version RC7 Poke-Thru Device is proprietary and can only be replaced with the RC37REC or RC37REC-25.</p>	
RC7APTCHK RC7APTCHGY	<p>Abandonment Plate – Abandonment available in black (RC7APTCHK) or gray (RC7APTCHGY).</p> <p>Country of Origin: Mexico</p>				

NOTE: To abandon the RC7 Series Poke-Thru Device, the internal gasket, duplex receptacle, and communication modules must not be removed in order to maintain UL Classification. Also the stem must remain in the core-drilled hole.

* Poke-Thru Devices on this page are available in some or all of the following cover color options as indicated by the part numbers:

- GY – Gray painted flange with gray nonmetallic cover,
- BK – Black painted flange with black nonmetallic cover,
- AL – Brushed Aluminum flange with black nonmetallic cover
- BS – Brushed Brass flange with black nonmetallic cover
- AA – Brushed Aluminum flange with aluminum-colored nonmetallic cover
- AB – Brushed Brass flange with brass-colored nonmetallic cover

Where applicable, slide covers match the cover color.

NOTE: See page 3 for specifications.

3 1/16" HOLE SIZE POKE-THRU DEVICES

RC9 Series Poke-Thru Devices Ordering Information

Catalog No./Item Description/Specifications

RC9STC

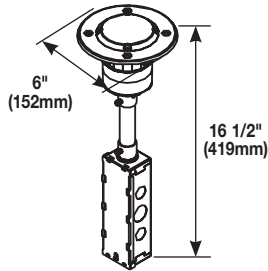

Insert Assembly with Disposable Plate – Includes prewired 15A quad receptacle. Use with RC9C Series Covers to complete installation.

Country of Origin: Mexico

- RC9CTCGY*
- RC9CTCBK*
- RC9CTCAL*
- RC9CTCBS*
- RC9CTCAB*

Finish Flange & Slide Holder Assembly – Cover assembly includes two openings for pass-through capability for one 4-pair Category 5e or Category 6 cable per opening.

Country of Origin: Mexico

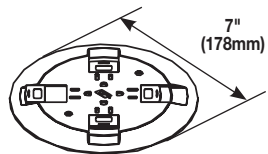

NOTE: Assembled with scrub water gasket. For use on tile or carpet floors.

CAUTION: Not intended for use on polished concrete or terrazzo floor applications.

Catalog Number Explanation				
RC9A15TCGY				
RC9	A	15	TC	GY
Identifies Poke-Thru Series	Identifies Assembled Unit (A) or Cover (C)	Identifies 15A Quad Power Receptacle	Identifies that Unit is Approved for Tile and Carpet Floors	Identifies Color of Cover Assembly (See below for details)

- RC9A15TCGY*
- RC9A15TCBK*
- RC9A15TCAL*
- RC9A15TCBS*
- RC9A15TCAB*

Poke-Thru Assembly – Prewired 15A quad receptacle can be wired as standard quad receptacle or isolated ground. Unit also includes two openings for pass-through capability for one 4-pair Category 5e or Category 6 cable per opening.

Country of Origin: Mexico

NOTE: Assembled with scrub water gasket. For use on tile or carpet floors.

CAUTION: Not intended for use on polished concrete or terrazzo floor applications.

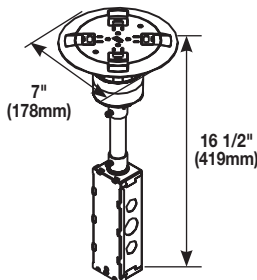

Catalog No./Item Description/Specifications

- RC9SHTCBKCR*
- RC9SHTCBSCR*
- RC9SHTCGYCR*
- RC9SHTCAACR*

Poke-Thru Slide Controlled Receptacle – Nonmetallic Slide Holder Assembly with Controlled Receptacle Markings. Markings are located in a recess pad and are permanent indicating the quad receptacle below has been wired up to comply with 2014 NEC®, CA Title 24 and ASHRAE Energy Efficiency Standard 90.1. Available in black (RC9SHTCBKCR), brass (RC9SHTCBSCR), gray (RC9SHTCGYCR), and aluminum (RC9SHTCAACR). Slide holder to be used with RC9A15TC and RC9CTC units.

Country of Origin: Mexico

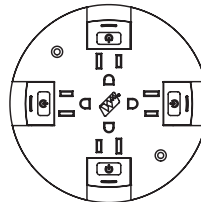

- RC9SHTCBK*
- RC9SHTCBS*
- RC9SHTCGY*

Nonmetallic Slide Holder Assembly – Available in black (RC9SHTCBK), nonmetallic brass (RC9SHTCBS), and gray (RC9SHTCGY).

Country of Origin: Mexico

NOTE: Assembled with scrub water gasket. For use on tile or carpet floors.

RC9APTCBK

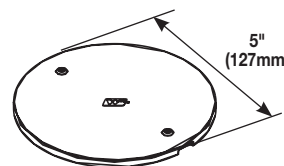

Abandonment Plate – Abandonment available in black (RC9APTCBK).

Country of Origin: Mexico

NOTE: To abandon the RC9 Series Poke-Thru Device, the internal gasket and quad receptacle must not be removed in order to maintain UL Classification. Also, the stem must remain in the core-drilled hole.

* Poke-Thru Devices on this page are available in some or all of the following cover color options as indicated by the part numbers:

- GY – Gray painted flange with gray nonmetallic cover,
- BK – Black painted flange with black nonmetallic cover,
- AL – Brushed aluminum flange with black nonmetallic cover
- BS – Brushed brass flange with black nonmetallic cover
- AA – Brushed aluminum flange with aluminum-colored nonmetallic cover
- AB – Brushed brass flange with brass-colored nonmetallic cover

Where applicable, slide covers match the cover color.

NOTE: See page 3 for specifications.

3 1/16" HOLE SIZE POKE-THRU DEVICES

RC9 Series Poke-Thru Devices Ordering Information

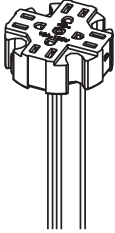
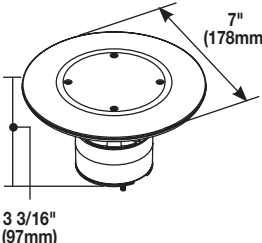
Catalog No./Item	Description/Specifications	Catalog No./Item	Description/Specifications
RC9REC	 <p>Replacement Receptacle – Prewired 15A quad receptacle can be wired as standard receptacle or isolated ground. Available only in black. See installation instructions with replacement receptacle for complete installation details.</p> <p>Country of Origin: Mexico</p>	 <p>ABPLUG3</p> <p>7" (178mm)</p> <p>3 3/16" (97mm)</p> <p>Abandonment Plug Assembly – Complete plug assembly for abandoning an open 3" (76mm) cored-hole. Assembly includes intumescent fire-stop material to maintain the fire-classification of the floor, integral retainer ring to prevent the unit from pulling up through the floor, and a black die-cast aluminum cover.</p> <p>Country of Origin: Mexico</p> <p>CAUTION: Not intended for use on polished concrete or terrazzo floor applications.</p>	

NOTE: See page 3 for specifications.

3 1/16" HOLE SIZE POKE-THRU DEVICES

RC9AMD Series Poke-Thru Devices Ordering Information

Catalog No./Item Description/Specifications

RC9AM2STC

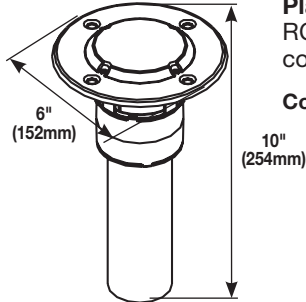

Insert Flange with Disposable Plate – Use with RC9C and RC9CMD, Series Covers to complete installation.

Country of Origin: Mexico

**RC9CMDTCGY*
RC9CMDTCBK*
RC9CMDTCAL*
RC9CMDTCBS*
RC9CMDTCAB***

Finish Flange & Slide Holder Assembly – Includes adapters to accept four (4) Ortronics® TracJack modular jacks, two (2) Series II modular jacks (Devices sold separately) and Wiremold Open System inserts.

Country of Origin: Mexico

NOTE: Assembled with scrub water gasket. For use on tile or carpet floors.

CAUTION: Not intended for use on polished concrete or terrazzo floor applications.

NOTE: Modular Jacks sold separately.

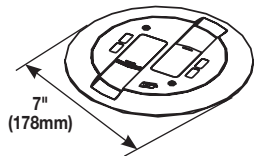

**RC9SHMDTCBK*
RC9SHMDTCGY*
RC9SHMDTCBS***

Nonmetallic Slide Holder Assembly – available in black (RC9SHMDTCBK), gray (RC9SHMDTCGY) and nonmetallic brass (RC9SHMDTCBS).

Country of Origin: Mexico

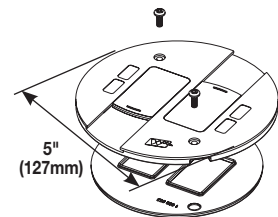

* Poke-Thru Devices on this page are available in some or all of the following cover color options as indicated by the part numbers:

- GY – Gray painted flange with gray nonmetallic cover,
- BK – Black painted flange with black nonmetallic cover,
- AL – Brushed Aluminum flange with black nonmetallic cover
- BS – Brushed Brass flange with black nonmetallic cover
- AA – Brushed Aluminum flange with aluminum-colored nonmetallic cover
- AB – Brushed Brass flange with brass-colored nonmetallic cover

Where applicable, slide covers match the cover color.

Catalog No./Item Description/Specifications

Catalog Number Explanation RC9AMDTCGY			
RC9	A	TC	GY
Identifies Poke-Thru Series	Identifies Assembled Unit (A) or Cover (C)	Identifies that Unit is approved for Tile and Carpet Floors	Identifies Color of Cover Assembly (See below)

**RC9AMDTCGY*
RC9AMDTCBK*
RC9AMDTCAL*
RC9AMDTCBS*
RC9AMDTTAB*
RC9AMDTCAA***

Poke-Thru Assembly – All communication device accepts up to four UTP connectors. Includes with bezels to accept four (4) Ortronics® TracJack modular jacks and two (2) Series II modular jacks (Devices sold separately) and Wiremold Open System Inserts.

Country of Origin: Mexico

NOTE: Assembled with scrub water gasket. For use on tile or carpet floors.

CAUTION: Not intended for use on polished concrete or terrazzo floor applications.

NOTE: Modular Jacks sold separately.

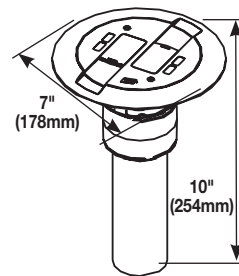

RC9APTGBK

Abandonment Plate – Abandonment available in black (RC9APTGBK).

Country of Origin: Mexico

NOTE: To abandon the RC9 Series Poke-Thru Device, the internal gasket and quad receptacle must not be removed in order to maintain UL Classification. Also, the stem must remain in the core-drilled hole.

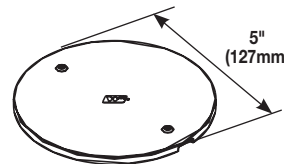

ABPLUG3

Abandonment Plug Assembly – Complete plug assembly for abandoning an open 3" (76mm) cored-hole. Assembly includes intumescent fire-stop material to maintain the fire-classification of the floor, integral retainer ring to prevent the unit from pulling up through the floor, and a black die-cast aluminum cover.

Country of Origin: Mexico

CAUTION: Not intended for use on polished concrete or terrazzo floor applications.

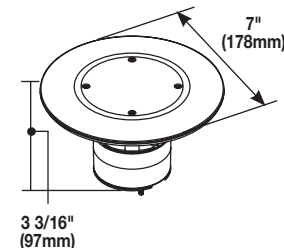

NOTE: See page 3 for specifications.

4" HOLE SIZE POKE-THRU DEVICES

AV3 Series Poke-Thru Devices Ordering Information

Catalog No./Item Description/Specifications

AV3STC

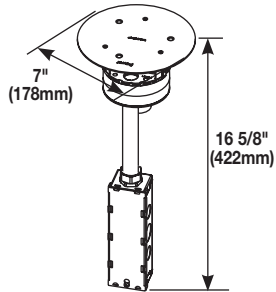

Insert Assembly with Disposable Plate – Use with AV3C Series covers to complete installation.

Country of Origin: Mexico

- AV3CTCGY*
- AV3CTCBK*
- AV3CTCAL*
- AV3CTCAA*
- AV3CTCBS*
- AV3CTCAB*

Finish Flange & Slide Holder Assembly – Includes one prewired 20A duplex receptacle which can be wired as a standard receptacle or isolated ground. Includes one Extron adapter to accept Extron MAAP mini architectural adapter plates. (Extron devices sold separately, only through authorized Extron dealers). Includes Ortronics® TracJack and Series II mounting adapters and Wiremold Open System adapters and inserts.

Country of Origin: Mexico

NOTE: Assembled with scrub water gasket. For use on tile or carpet floors.

CAUTION: Not intended for use on polished concrete or terrazzo floor applications.

NOTE: Modular Jacks sold separately.

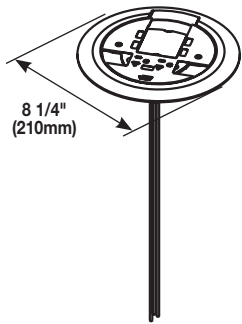

- AV3SHTCBKCR*
- AV3SHTCBSCR*
- AV3SHTCBKCR*
- AV3SHTCGYCR*
- AV3SHTCAACR*

Poke-Thru Controlled Receptacle – Nonmetallic Slide Holder Assembly with Controlled Receptacle Markings. Markings are located in a recess pad and are permanent indicating the duplex receptacle below has been wired up to comply with 2014 NEC®, CA Title 24 and ASHRAE Energy Efficiency Standard 90.1. Available in black (BK), brass (BS), gray (GY) and aluminum (AA). Slide holder to be used with the AV3ATC and AV3CTC units.

Country of Origin: Mexico

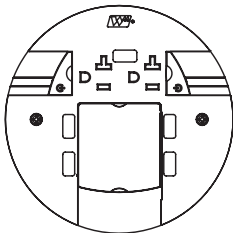

Catalog No./Item Description/Specifications

Catalog Number Explanation AV3ATCAL			
AV3	A	TC	AL
Identifies Poke-Thru Series	Identifies Assembled Unit (A) or Cover (C)	Identifies that Unit is approved for Tile and Carpet Floors	Identifies Color of Cover Assembly (See below)

- AV3ATCGY*
- AV3ATCBK*
- AV3ATCAL*
- AV3ATCAA*
- AV3ATCBS*
- AV3ATCAB*

Assembled Unit – A/V device includes one prewired 20A duplex receptacle which can be wired as a standard receptacle or isolated ground. Includes one Extron bezel to accept Extron MAAP mini architectural adapter plates. (Extron devices sold separately, only through authorized Extron dealers). Includes Ortronics® TracJack and Series II mounting adapters and Wiremold Open System adapters and inserts.

Country of Origin: Mexico

NOTE: Assembled with scrub water gasket. For use on tile or carpet floors.

CAUTION: Not intended for use on polished concrete or terrazzo floor applications.

NOTE: Modular Jacks sold separately.

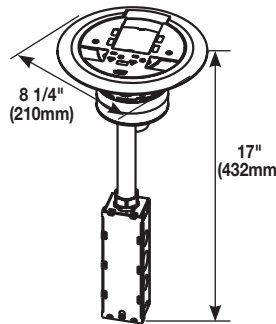

- AV3SHTCGY*
- AV3SHTCBK*
- AV3SHTCAL*
- AV3SHTCBS*

Nonmetallic Slide Holder Assembly – Available in gray (GY), black (BK), aluminum colored (AL) and brass colored (BS).

Country of Origin: Mexico

NOTE: Assembled with scrub water gasket. For use on tile or carpet floors.

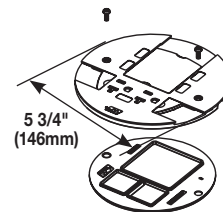

* Poke-Thru Devices on this page are available in some or all of the following cover color options as indicated by the part numbers:

- GY – Gray painted flange with gray nonmetallic cover,
- BK – Black painted flange with black nonmetallic cover,
- AL – Brushed Aluminum flange with black nonmetallic cover
- BS – Brushed Brass flange with black nonmetallic cover
- AA – Brushed Aluminum flange with aluminum-colored nonmetallic cover
- AB – Brushed Brass flange with brass-colored nonmetallic cover

Where applicable, slide covers match the cover color.

NOTE: See page 3 for specifications.

4" HOLE SIZE POKE-THRU DEVICES

AV3 Series Poke-Thru Devices Ordering Information

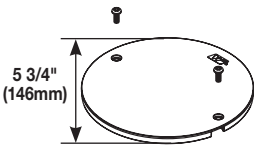
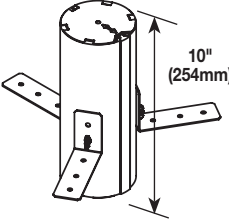
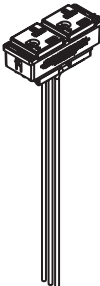
Catalog No./Item	Description/Specifications	Catalog No./Item	Description/Specifications
AV3APTCGY AV3APTCBK 	<p>Abandonment plate – Abandonment available in black (BK) and gray (GY).</p> <p>Country of Origin: Mexico</p>	4PPS 	<p>4" Pre-Pour Poke-Thru Sleeve – Nonmetallic sleeve attaches to structural decking and maintains 4" – 4 1/8" (102mm – 105mm) diameter cast in core hole. Unit includes three (3) attachment legs and three (3) thumb screws.</p> <p>Country of Origin: USA</p>
RC37REC RC37REC-25 	<p>Replacement Receptacle – Prewired snap-in 20A receptacle can be wired as standard duplex or isolated ground. Available only in black. See installation instructions with replacement receptacle for complete installation details. The RC37REC-25 is available with 25 foot leads and can be wired as standard duplex or isolated ground.</p> <p>Country of Origin: Mexico</p> <p>NOTE: The 20A duplex receptacle supplied with the scrub water version AV3 Poke-Thru Device is proprietary and can only be replaced with the RC37REC or RC37REC-25.</p>		

** Also includes junction box attached to the 3/4" conduit.

4" HOLE SIZE POKE-THRU DEVICES

AMD8 Series Poke-Thru Devices Ordering Information

Catalog No./Item Description/Specifications

AMD8STC

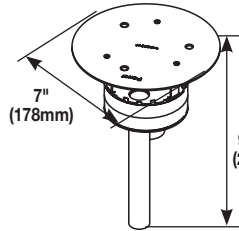

Insert Assembly with Disposable Plate – Use with AMD8C Series Covers to complete installation.

Country of Origin: Mexico

- AMD8CTCGY*
- AMD8CTCBK*
- AMD8CTCAL*
- AMD8CTCAA*
- AMD8CTCBS*
- AMD8CTCAB*

Finish Flange & Slide Holder Assembly – Includes adapters to accept eight (8) Ortronics® TracJack inserts and four (4) Series II inserts (Devices sold separately) and Wiremold Open System adapters and inserts.

Country of Origin: Mexico

NOTE: Assembled with scrub water gasket. For use on tile or carpet floors.

CAUTION: Not intended for use on polished concrete or terrazzo floor applications.

NOTE: Modular Jacks sold separately.

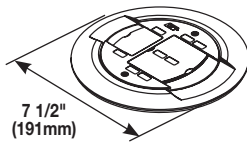

- AMD8SHTCGY*
- AMD8SHTCBK*
- AMD8SHTCAL*
- AMD8SHTCBS*

Nonmetallic Slide Holder Assembly – Available in gray (AMD8SHTCGY), black (AMD8SHTCBK), aluminum colored (AMD8SHTCAL), brass colored (AMD8SHTCBS).

Country of Origin: Mexico

NOTE: Assembled with scrub water gasket. For use on tile or carpet floors.

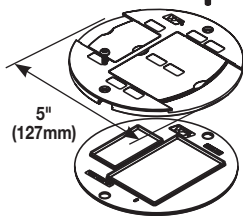

- AMD8APTCGY
- AMD8APTCBK

Abandonment Plate – Abandonment available in black (AMD8APTCBK) and gray (AMD8APTCGY).

Country of Origin: Mexico

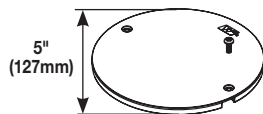

* Poke-Thru Devices on this page are available in some or all of the following cover color options as indicated by the part numbers:

- GY – Gray painted flange with gray nonmetallic cover,
- BK – Black painted flange with black nonmetallic cover,
- AL – Brushed Aluminum flange with black nonmetallic cover
- BS – Brushed Brass flange with black nonmetallic cover
- AA – Brushed Aluminum flange with aluminum-colored nonmetallic cover
- AB – Brushed Brass flange with brass-colored nonmetallic cover

Where applicable, slide covers match the cover color.

NOTE: See page 3 for specifications.

Catalog No./Item Description/Specifications

Catalog Number Explanation AMD8ATCAL			
AMD8	A	TC	AL
Identifies Poke-Thru Series	Identifies Assembled Unit (A) or Cover (C)	Identifies that Unit is approved for Tile and Carpet Floors	Identifies Color of Cover Assembly (See below)

- AMD8ATCGY*
- AMD8ATCBK*
- AMD8ATCAL*
- AMD8ATCAA*
- AMD8ATCBS*
- AMD8ATCAB*

Poke-Thru Assembly – All communication device accepts up to eight (8) UTP, fiber optic, audio, or video connectors. Includes adapters to accept eight (8) Ortronics® TracJack inserts and four (4) Series II inserts (Devices sold separately) and Wiremold Open System adapters and inserts.

Country of Origin: Mexico

NOTE: Assembled with scrub water gasket. For use on tile or carpet floors.

CAUTION: Not intended for use on polished concrete or terrazzo floor applications.

NOTE: Modular Jacks sold separately.

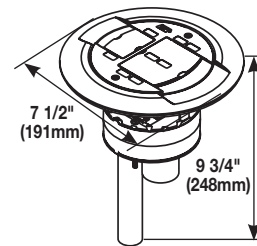

ABPLUG4

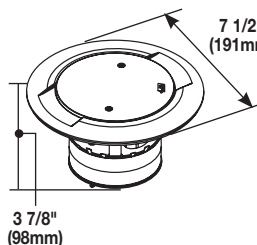

Abandonment Plug Assembly – Complete plug assembly for abandoning an open 4" (102mm) cored-hole. Assembly includes intumescent fire-stop material to maintain the fire-classification of the floor, integral retainer ring to prevent the unit from pulling up through the floor, and a black die-cast aluminum cover.

Country of Origin: Mexico

CAUTION: Not intended for use on polished concrete or terrazzo floor applications.

4PPS

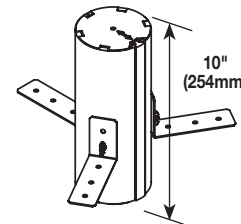

4" Pre-Pour Poke-Thru Sleeve – Nonmetallic sleeve attaches to structural decking and maintains 4" – 4 1/8" (102mm – 105mm) diameter cast in core hole. Unit includes three (3) attachment legs and three (3) thumb screws.

Country of Origin: USA

4" HOLE SIZE POKE-THRU DEVICES

RC4 Series Poke-Thru Devices Ordering Information

Catalog No./Item Description/Specifications

RC4STC

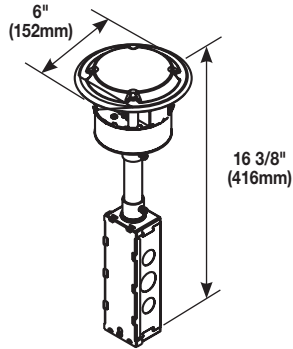

Insert Assembly with Disposable Plate – Comes complete with four prewired 20A receptacles. Use RC4STC with RC4C Series Covers.

Country of Origin: Mexico

- RC4CTCGY*
- RC4CTCBK*
- RC4CTCAL*
- RC4CTCAA*
- RC4CTCBS*
- RC4CTCAB*

Finish Flange & Slide Holder Assembly – Wiremold open system unloaded inserts to accept four discrete keystone connectors from most manufacturers are provided. Includes Ortronics® TracJack mounting adapter and Series II communication housing. (Devices sold separately.)

Country of Origin: Mexico

NOTE: Assembled with scrub water gasket. For use on tile or carpet floors.

CAUTION: Not intended for use on polished concrete or terrazzo floor applications.

NOTE: Modular Jacks sold separately.

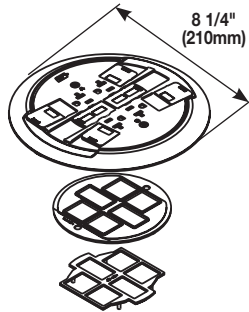

- RC4SHTCGY*
- RC4SHTCBK*
- RC4SHTCBS*
- RC4SHTCAA*

Nonmetallic Slide Holder Assembly – Available in black (RC4SHTCBK), gray (RC4SHTCGY), nonmetallic brass (RC4SHTCBS), and nonmetallic aluminum (RC4SHTCAA).

Country of Origin: Mexico

NOTE: Assembled with scrub water gasket. For use on tile or carpet floors.

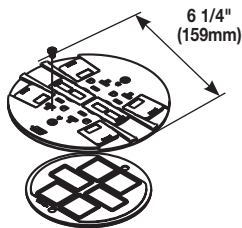

* Poke-Thru Devices on this page are available in some or all of the following cover color options as indicated by the part numbers:

- GY – Gray painted flange with gray nonmetallic cover,
- BK – Black painted flange with black nonmetallic cover,
- AL – Brushed Aluminum flange with black nonmetallic cover
- BS – Brushed Brass flange with black nonmetallic cover
- AA – Brushed Aluminum flange with aluminum-colored nonmetallic cover
- AB – Brushed Brass flange with brass-colored nonmetallic cover

Where applicable, slide covers match the cover color.

NOTE: See page 3 for specifications.

Catalog No./Item Description/Specifications

Catalog Number Explanation RC4ATCAL			
RC4	A	TC	AL
Identifies Poke-Thru Series	Identifies Assembled Unit (A) or Cover (C)	Identifies that Unit is approved for Tile and Carpet Floors	Identifies Color of Cover Assembly (See below)

- RC4ATCGY*
- RC4ATCBK*
- RC4ATCAL*
- RC4ATCAA*
- RC4ATCBS*
- RC4ATCAB*

Assembled Unit – Unit includes four prewired 20A receptacles. Each duplex receptacle is wired as a separate circuit. The duplex can be wired as a standard receptacle or isolated ground. Wiremold Open System unloaded inserts to accept four discrete keystone connectors from most manufacturers are included. Includes Ortronics® TracJack mounting adapter and Series II communication housing. (Devices sold separately.)

Country of Origin: Mexico

NOTE: Assembled with scrub water gasket. For use on tile or carpet floors.

CAUTION: Not intended for use on polished concrete or terrazzo floor applications.

NOTE: Modular Jacks sold separately.

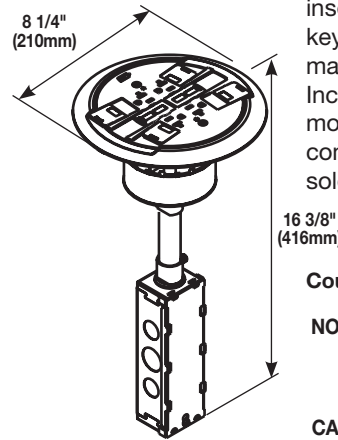

- RC4KTCBK*
- RC4KTCGY*
- RC4KTCAL*
- RC4KTCBS*
- RC4KTCAB*

Retrofit Kit – Used to upgrade existing installations of RC4 Poke-Thru Devices on carpet floors to meet scrub water requirements. Includes two 20A duplex receptacles that can be wired as a standard duplex or isolated ground. Also includes scrub water finish flange and slide holder assembly. Flange available in painted black (BK), gray (GY), and brushed metal finishes in aluminum (AL), and brass (BS). See installation instructions with retrofit kit for complete installation details.

Country of Origin: Mexico

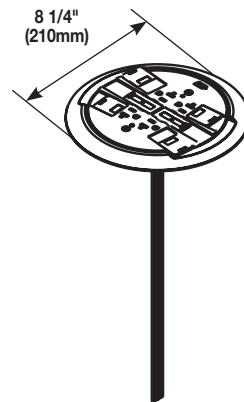

4" HOLE SIZE POKE-THRU DEVICES

RC4 Series Poke-Thru Devices Ordering Information

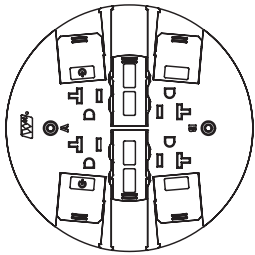
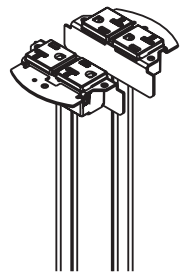
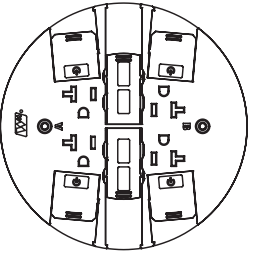
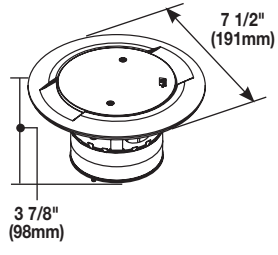
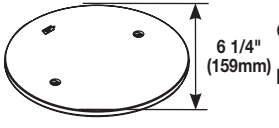
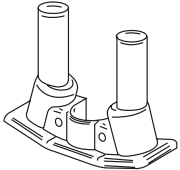
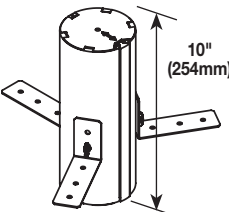
Catalog No./Item	Description/Specifications	Catalog No./Item	Description/Specifications
RC4SHTCBK2CR* RC4SHTCBS2CR* RC4SHTCGY2CR* RC4SHTCAA2CR*	<p>Poke-Thru Controlled Receptacle – Nonmetallic Slide Holder Assembly with Controlled Receptacle Markings. Markings are located in a recess pad and are permanent indicating the duplex receptacle below has been wired up to comply with 2014 NEC®, CA Title 24 and ASHRAE Energy Efficiency Standard 90.1. Available in, black (BK) brass (BS), gray (GY), and aluminum (AA). On circuit “A” duplex receptacles are controlled. Slide holder to be used with the RC4ATC & RC4CTC units.</p> <p>Country of Origin: Mexico</p>	RC4REC2 RC4REC2-25	<p>Replacement Receptacle – Two prewired 20A duplex receptacles can be wired as standard duplex or isolated ground. Available only in black. See installation instructions with replacement receptacle for complete installation details. RC4REC2-25 is available with 25 foot leads and can be wired as standard duplex or isolated ground.</p> <p>Country of Origin: Mexico</p> <p>NOTE: The 20A duplex receptacle supplied with the scrub water version RC4 Poke-Thru Device is proprietary and can only be replaced with the RC4REC2 or RC4REC2-25.</p>
RC4SHTCBK4CR* RC4SHTCBS4CR* RC4SHTCGY4CR* RC4SHTCAA4CR*	<p>Poke-Thru Controlled Receptacle – Nonmetallic Slide Holder Assembly with Controlled Receptacle Markings. Markings are located in a recess pad and are permanent indicating both of the duplex receptacles below have been wired up to comply with 2014 NEC®, CA Title 24 and ASHRAE Energy Efficiency Standard 90.1. Available in black (BK), brass (BS), gray (GY), and aluminum (AA). Both circuit duplex receptacles are controlled. Slide holder to be used with the RC4ATC & RC4CTC units.</p> <p>Country of Origin: Mexico</p>	ABPLUG4	<p>Abandonment Plug Assembly – Complete plug assembly for abandoning an open 4" (102mm) cored-hole. Assembly includes intumescent fire-stop material to maintain the fire-classification of the floor, integral retainer ring to prevent the unit from pulling up through the floor, and a black die-cast aluminum cover.</p> <p>Country of Origin: Mexico</p> <p>CAUTION: Not intended for use on polished concrete or terrazzo floor applications.</p>
RC4APTCBK* RC4SAPTCGY* RC4SAPTCAB*	<p>Abandonment Plate – Available in black (RC4APTCBK), gray (RC4SAPTCGY), painted and brass (RC4SAPTCAB).</p> <p>Country of Origin: Mexico</p> <p>NOTE: To abandon the RC4 Series Poke-Thru Device, the internal gasket, duplex receptacle, and communication modules must not be removed in order to maintain UL Classification. Also the stem must remain in the core-drilled hole.</p>	COM50 COM75	<p>Communication Adapter – For two 1/2" trade size conduit connections (COM50). For two 3/4" trade size conduit connections (COM75).</p> <p>Country of Origin: Mexico</p> <p>NOTE: No additional capacity with COM75.</p> <p>Max concrete thickness of 7.5" when COM50 is used</p>
			
			
			
		4PPS	<p>4" Pre-Pour Poke-Thru Sleeve – Nonmetallic sleeve attaches to structural decking and maintains 4" – 4 1/8" (102mm – 105mm) diameter cast in core hole. Unit includes three (3) attachment legs and three (3) thumb screws.</p> <p>Country of Origin: USA</p>
			

* Poke-Thru Devices on this page are available in some or all of the following cover color options as indicated by the part numbers:
 GY – Gray painted flange with gray nonmetallic cover,
 BK – Black painted flange with black nonmetallic cover,
 AL – Brushed Aluminum flange with black nonmetallic cover
 BS – Brushed Brass flange with black nonmetallic cover
 AA – Brushed Aluminum flange with aluminum-colored nonmetallic cover
 AB – Brushed Brass flange with brass-colored nonmetallic cover

Where applicable, slide covers match the cover color.
NOTE: See page 3 for specifications.

4" HOLE SIZE POKE-THRU DEVICES

RC3 Series Poke-Thru Devices Ordering Information

Catalog No./Item Description/Specifications

RC3STC

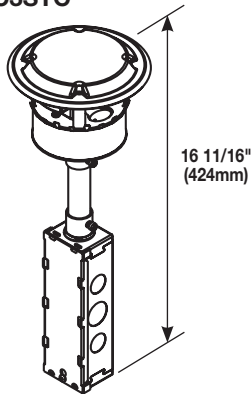

Insert Assembly with Disposable Plate – Use with RC3C Series Covers to complete installation.

Country of Origin: Mexico

RC3CTCGY*
RC3CTCBK*
RC3CTCAL*
RC3CTCBS*
RC3CTCAB*
RC3CTCAA*

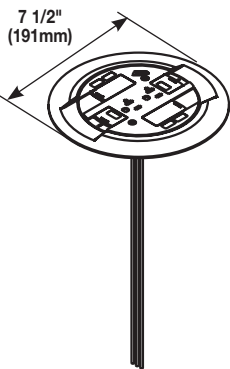

Finish Flange and Slide Holder Assembly – Prewired 20A duplex receptacle can be wired as standard duplex or isolated ground. Wiremold Open System unloaded inserts to accept four discrete keystone connectors from most manufacturers are provided. Includes two (2) Ortronics® TracJack mounting adapters and two (2) Series II adapters. (Devices sold separately.)

Country of Origin: Mexico

NOTE: Assembled with scrub water gasket. For use on tile or carpet floors.

CAUTION: Not intended for use on polished concrete or terrazzo floor applications.

NOTE: Modular Jacks sold separately.

RC3SHTCGY*
RC3SHTCBK*
RC3SHTCBS*

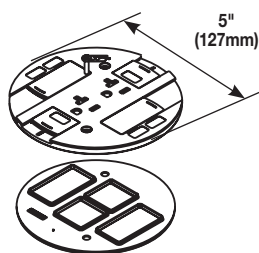

Nonmetallic Slide Holder Assembly – Available in black (RC3SHTCBK), gray (RC3SHTCGY) and nonmetallic brass (RC3SHTCBS).

Country of Origin: Mexico

NOTE: Assembled with scrub water gasket. For use on tile or carpet floors.

Catalog No./Item Description/Specifications

Catalog Number Explanation RC3ATCAL			
RC3	A	TC	AL
Identifies Poke-Thru Series	Identifies Assembled Unit (A) or Cover (C)	Identifies that Unit is approved for Tile and Carpet Floors	Identifies Color of Cover Assembly (See below)

RC3ATCGY*
RC3ATCBK*
RC3ATCAL*
RC3ATCAA*
RC3ATCBS*
RC3ATCAB*

Assembled Unit – Prewired 20A duplex receptacle can be wired as standard duplex or isolated ground. Wiremold Open System unloaded inserts to accept four discrete keystone connectors from most manufacturers are provided. Includes two (2) Ortronics® TracJack mounting adapters and two (2) Ortronics Series II adapters. (Devices sold separately.)

Country of Origin: Mexico

NOTE: Assembled with scrub water gasket. For use on tile or carpet floors.

CAUTION: Not intended for use on polished concrete or terrazzo floor applications.

NOTE: Modular Jacks sold separately.

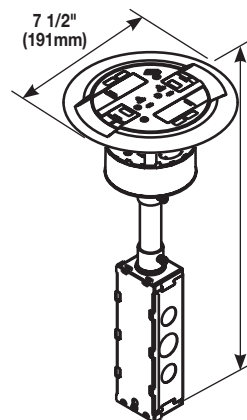

RC3KTCGY*
RC3KTCBK*
RC3KTCAL*
RC3KTCBS*

Retrofit Kit – Used to upgrade existing installations of RC3 Poke-Thru Devices on carpet floors to meet scrub water requirements. Includes 20A duplex receptacle that can be wired as a standard duplex or isolated ground. Also includes scrub water finish flange and slide holder assembly. Flange available in painted black (BK), gray (GY), and brushed metal finishes in aluminum (AL), and brass (BS). Kit also includes duplex receptacle barrier. Old barrier must be replaced with new. See installation instructions with retrofit kit for complete installation details.

Country of Origin: Mexico

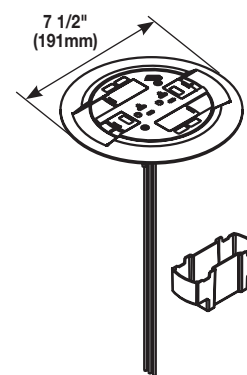

* Poke-Thru Devices on this page are available in some or all of the following cover color options as indicated by the part numbers:

- GY – Gray painted flange with gray nonmetallic cover,
- BK – Black painted flange with black nonmetallic cover,
- AL – Brushed Aluminum flange with black nonmetallic cover
- BS – Brushed Brass flange with black nonmetallic cover
- AA – Brushed Aluminum flange with aluminum-colored nonmetallic cover
- AB – Brushed Brass flange with brass-colored nonmetallic cover

Where applicable, slide covers match the cover color.

NOTE: See page 3 for specifications.

4" HOLE SIZE POKE-THRU DEVICES

RC3 Series Poke-Thru Devices Ordering Information

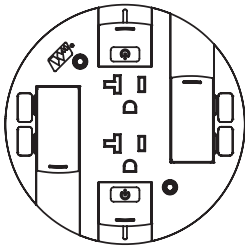
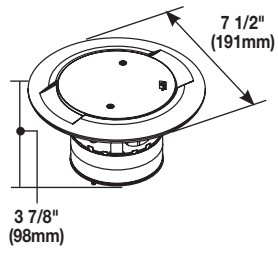
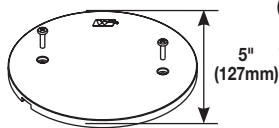
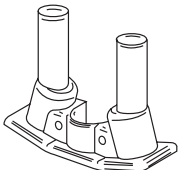
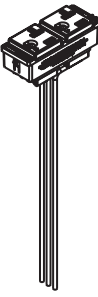
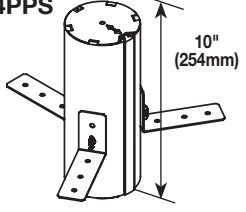
Catalog No./Item	Description/Specifications	Catalog No./Item	Description/Specifications
<p>RC3STCBKCR* RC3STCBSCR* RC3STCGYCR* RC3STCAACR*</p> 	<p>Poke-Thru Controlled Receptacle – Nonmetallic Slide Holder Assembly with Controlled Receptacle Markings. Markings are located in a recess pad and are permanent indicating the duplex receptacle below has been wired up to comply with 2014 NEC®, CA Title 24 and ASHRAE Energy Efficiency Standard 90.1. Available in black (BK), brass (BS), gray (GY), and aluminum (AA). Slide holder to be used with the RC3ATC and RC3CTC units.</p> <p>Country of Origin: Mexico</p>	<p>ABPLUG4</p> 	<p>Abandonment Plug Assembly – Complete plug assembly for abandoning an open 4" (102mm) cored-hole. Assembly includes intumescent fire-stop material to maintain the fire-classification of the floor, integral retainer ring to prevent the unit from pulling up through the floor, and a black die-cast aluminum cover.</p> <p>Country of Origin: Mexico</p> <p>CAUTION: Not intended for use on polished concrete or terrazzo floor applications.</p>
<p>RC3APTCBK RC3SAPTCGY</p> 	<p>Abandonment Plate – Abandonment available in black (RC3APTCBK), gray (RC3SAPTCGY).</p> <p>Country of Origin: Mexico</p> <p>NOTE: To abandon the RC3 Series Poke-Thru Device, the internal gasket, duplex receptacle, and communication modules must not be removed in order to maintain UL Classification. Also the stem must remain in the core-drilled hole.</p>	<p>COM50 COM75</p> 	<p>Communication Adapter – For two 1/2" trade size conduit connections (COM50). For two 3/4" trade size conduit connections (COM75).</p> <p>Country of Origin: Mexico</p> <p>NOTE: No additional capacity with COM75.</p> <p>Max concrete thickness of 7.5" when COM50 is used</p>
<p>RC37REC RC37REC-25</p> 	<p>Replacement Receptacle – Prewired snap-in 20A receptacle can be wired as standard duplex or isolated ground. Available only in black. See installation instructions with replacement receptacle for complete installation details. The RC37REC-25 is available with 25 foot leads and can be wired as standard duplex or isolated ground.</p> <p>Country of Origin: Mexico</p> <p>NOTE: The 20A duplex receptacle supplied with the scrub water version AV3 Poke-Thru Device is proprietary and can only be replaced with the RC37REC or RC37REC-25.</p>	<p>4PPS</p> 	<p>4" Pre-Pour Poke-Thru Sleeve – Nonmetallic sleeve attaches to structural decking and maintains 4" – 4 1/8" (102mm – 105mm) diameter cast in core hole. Unit includes three (3) attachment legs and three (3) thumb screws.</p> <p>Country of Origin: USA</p>

* Poke-Thru Devices on this page are available in some or all of the following cover color options as indicated by the part numbers:
 GY – Gray painted flange with gray nonmetallic cover,
 BK – Black painted flange with black nonmetallic cover,
 AL – Brushed Aluminum flange with black nonmetallic cover
 BS – Brushed Brass flange with black nonmetallic cover
 AA – Brushed Aluminum flange with aluminum-colored nonmetallic cover
 AB – Brushed Brass flange with brass-colored nonmetallic cover

Where applicable, slide covers match the cover color.

NOTE: See page 3 for specifications.

NOTE: All brand and product names referenced in this document are registered trademarks or trademarks of their respective holders.



NOTE: The paper used to print this document is an environmentally responsible paper with 10% post consumer waste, with FSC and SFI Chain of Custody certifications, Lacey Act complaint. 100% of the electricity used to manufacture Flo sheets is generated with Green-e certified renewable energy.



Legrand, North America
60 Woodlawn Street
West Hartford, CT 06110
1.877.BY.LEGRAND (295.3472)
www.legrand.us

Canada
905.738.9195
www.legrand.ca

FOLLOW US

