

CATALOG CONTENTS

HOT DIPPED/MECHANICAL GALVANIZED FITTINGS	5
RIGID-IMC FITTINGS	25
EMT FITTINGS	95
LIQUIDTIGHT FITTINGS	123
AC-MC-FLEX FITTINGS	141
NM CABLE FITTINGS	165
CORD GRIP FITTINGS	173
GROUNDING FITTINGS	177
CLAMP & HANGER FITTINGS	181
SERVICE ENTRANCE FITTINGS	187
MISCELLANEOUS FITTINGS	199



HOT DIPPED/MECHANICAL GALVANIZED FITTINGS

Malleable Iron/Hot Dipped Galvanized Moguls with Cover, Gasket & Rollers.....	6	Malleable Iron/Mechanical Galvanized 90° Liquidtight Connectors.....	17
Malleable Iron/Hot Dipped Galvanized Moguls with Cover and Gasket.....	8	Malleable Iron/Mechanical Galvanized 45° Liquidtight Connectors.....	18
Malleable Iron/Hot Dipped Galvanized Threaded Conduit Bodies.....	11	Malleable Iron/Mechanical Galvanized Straight Liquidtight Connectors with Copper Lugs.....	19
Malleable Iron/Hot Dipped Galvanized Conduit Body Covers.....	13	Malleable Iron/Mechanical Galvanized 90° Liquidtight Connectors with Copper Lugs.....	20
Malleable Iron/Hot Dipped Galvanized Insulated Grounding Bushings.....	14	Malleable Iron/Mechanical Galvanized 45° Liquidtight Connectors with Copper Lugs.....	21
Malleable Iron/Hot Dipped Galvanized Watertight Conduit Hubs.....	15	Malleable Iron/Hot Dipped Galvanized One-Hole Straps.....	22
Malleable Iron/Hot Dipped Galvanized 3-Piece Couplings.....	15	Malleable Iron/Hot Dipped Galvanized Clamp Back Spacers.....	22
Malleable Iron/Mechanical Galvanized Straight Liquidtight Connectors.....	16	Malleable Iron/Hot Dipped Galvanized Cable Supports-Body Only.....	23

MALLEABLE IRON/HOT DIPPED GALVANIZED MOGULS WITH COVER, GASKET & ROLLERS

FOR THREADED RIGID CONDUIT AND IMC

APPLICATION

- Larger body size facilitates pulling of large and heavy conductors. Specially designed raised cast covers provide additional wiring area.
- SEPCO Moguls are used for pulling straight, 45° or 90° angle turns and/or making taps and splices.

FEATURES

- Exclusive built-in rollers facilitate cable pulling from sizes 1 1/4" - 4".
- Smooth, rounded integral bushing in each hub protects conductor insulation.
- Accurately taped, tapered threads for tight, rigid joints and ground continuity.
- Covers have captive stainless steel screws to speed installation, prevent 'freezing' of screws.
- Length Requirement: distance between centerline of each hub bushing (conduit stop) exceeds eight times the trade diameter of the conduit per NEC 314.28(A)(2).

STANDARD MATERIALS

Bodies and Covers: Malleable Iron
Gaskets: Neoprene
Screws: Stainless Steel

STANDARD FINISH

Bodies and Covers: Hot-Dipped Galvanized

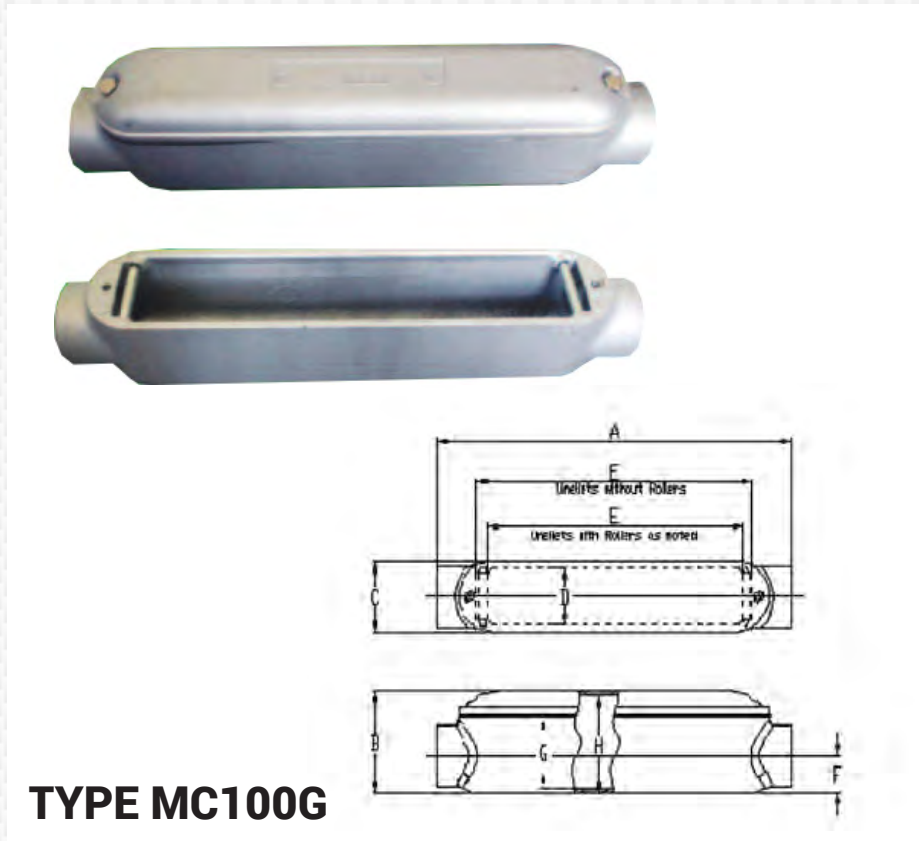

TYPE MC100G

CATALOG NUMBER	TRADE SIZE	MAX WIRE SIZE	VOL. CU.IN.	UNIT PACK	MASTER PACK	LBS. / 100 PCS.	UPC#
MC100G	1"	3 #2 AWG	31.00	—	1	390	10039
MC125G	1-1/4"	3 #1/0 AWG	50.00	—	1	506	10040
MC150G	1-1/2"	3 #3/0 AWG	93.00	—	1	923	10041
MC200G	2"	3 #300 MCM	143.00	—	1	1327	10042
MC250G	2-1/2"	3 #400 MCM	335.00	—	1	2751	10043
MC300G	3"	3 #700 MCM	475.00	—	1	3618	10044
MC350G	3-1/2"	3 #900 MCM	830.00	—	1	5464	10045
MC400G	4"	3 #1000 MCM	1010.00	—	1	6478	10046

CATALOG NUMBER	DIM A	DIM B	DIM C	DIM D	DIM E	DIM F	DIM G	DIM H	NUMBER OF COVER HOLES
MC100G	9.88	2.78	2.36	1.85	6.61	0.93	1.82	2.46	2
MC125G	12.20	3.43	2.44	1.93	7.83	1.14	2.27	3.11	2
MC150G	14.17	3.86	3.15	2.56	9.88	1.34	2.57	3.43	2
MC200G	18.15	4.41	3.15	2.52	13.29	1.63	3.13	3.98	2
MC250G	23.35	5.22	4.65	3.74	13.68	1.81	3.61	4.72	4
MC300G	27.17	6.06	4.72	3.66	21.04	2.20	4.45	5.57	4
MC350G	31.57	7.05	5.72	4.57	24.98	2.50	4.72	6.50	4
MC400G	35.55	7.56	5.72	4.57	29.11	2.76	5.23	7.01	4

MALLEABLE IRON/**HOT DIPPED GALVANIZED** MOGULS WITH COVER, GASKET & ROLLERS

FOR THREADED RIGID CONDUIT AND IMC

APPLICATION

- Larger body size facilitates pulling of large and heavy conductors. Specially designed raised cast covers provide additional wiring area.
- SEPCO Moguls are used for pulling straight, 45° or 90° angle turns and/or making taps and splices.

FEATURES

- Exclusive built-in rollers facilitate cable pulling from sizes 1 1/4" - 4".
- Smooth, rounded integral bushing in each hub protects conductor insulation.
- Accurately tapered, tapered threads for tight, rigid joints and ground continuity.
- Covers have captive stainless steel screws to speed installation, prevent 'freezing' of screws.
- Length Requirement: distance between centerline of each hub bushing (conduit stop) exceeds six times the trade diameter of the conduit per NEC 314.28(A)(2).

STANDARD MATERIALS

Bodies and Covers: Malleable Iron

Gaskets: Neoprene

Screws: Stainless Steel

STANDARD FINISH

Bodies and Covers: Hot-Dipped Galvanized

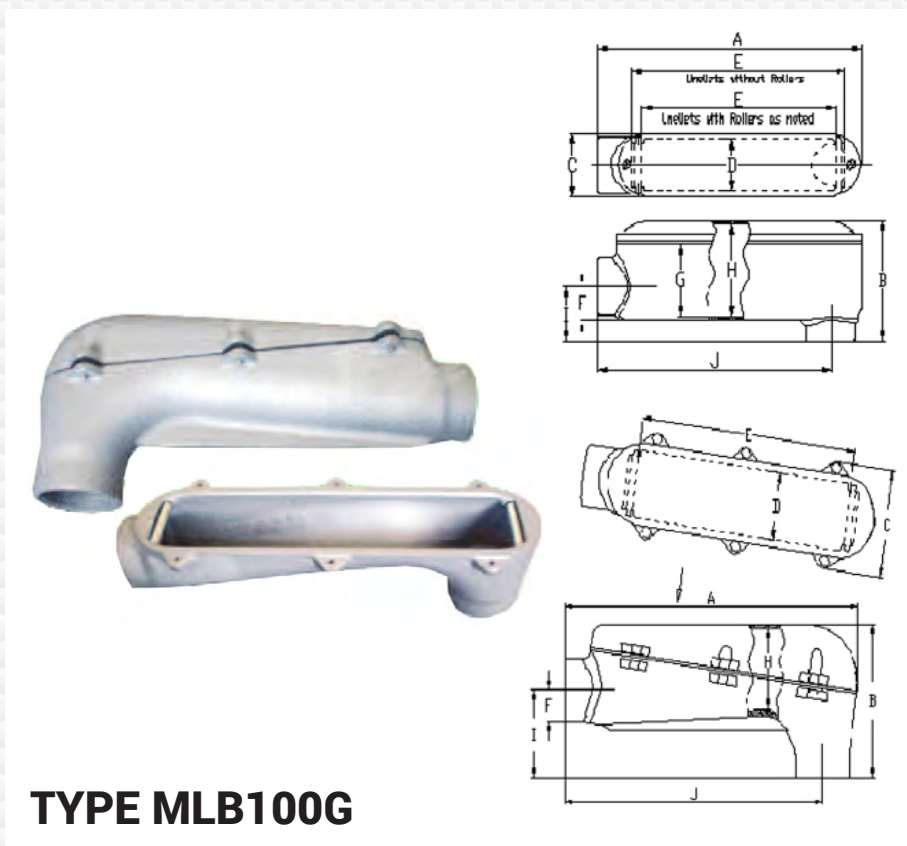

TYPE MLB100G

CATALOG NUMBER	TRADE SIZE	MAX WIRE SIZE	VOL. CU.IN.	UNIT PACK	MASTER PACK	LBS. / 100 PCS.	UPC#
MLB100G	1"	3 #2 AWG	31.00	—	1	366	10047
MLB125G	1-1/4"	3 #1/0 AWG	48.00	—	1	476	10048
MLB150G	1-1/2"	3 #3/0 AWG	107.00	—	1	831	10049
MLB200G	2"	3 #300 MCM	145.00	—	1	1224	10050
MLB250G	2-1/2"	3 #400 MCM	210.00	—	1	2104	10055
MLB300G	3"	3 #700 MCM	345.00	—	1	3237	10052
MLB350G	3-1/2"	3 #900 MCM	500.00	—	1	4427	10053
MLB400G	4"	3 #1000 MCM	740.00	—	1	5865	10054

CATALOG NUMBER	DIM A	DIM B	DIM C	DIM D	DIM E	DIM F	DIM G	DIM H	DIM I	DIM J	NUMBER OF COVER HOLES
MLB100G	8.90	3.75	2.38	1.87	6.57	0.94	1.88	2.52	1.89	7.87	2
MLB125G	9.65	4.86	2.40	1.89	6.47	1.16	2.70	3.52	2.19	8.48	2
MLB150G	12.95	5.25	3.07	2.40	9.49	1.38	3.09	4.07	2.36	11.63	2
MLB200G	14.65	6.38	3.11	2.52	10.91	1.61	3.46	4.96	2.64	12.94	2
MLB250G	18.22	8.23	5.79	3.60	13.48	2.15	—	4.36	4.69	16.03	6
MLB300G	21.33	10.37	5.79	3.47	16.95	2.75	—	5.27	5.61	18.62	6
MLB350G	24.65	10.97	6.93	4.53	19.94	3.01	—	5.15	6.63	21.55	6
MLB400G	27.67	13.03	7.01	4.57	23.38	3.43	—	6.85	7.05	24.32	6

MALLEABLE IRON/HOT DIPPED GALVANIZED MOGULS WITH COVER AND GASKET

FOR THREADED RIGID CONDUIT AND IMC

APPLICATION

- Larger body size facilitates pulling of large and heavy conductors. Specially designed raised cast covers provide additional wiring area.
- SEPCO Moguls are used for pulling straight, 45° or 90° angle turns and/or making taps and splices.

FEATURES

- Smooth, rounded integral bushing in each hub protects conductor insulation.
- Accurately taped, tapered threads for tight, rigid joints and ground continuity.
- Covers have captive stainless steel screws to speed installation, prevent 'freezing' of screws.
- Length Requirement: distance between centerline of each hub bushing (conduit stop) exceeds six times the trade diameter of the conduit per NEC 314.28(A)(2).

STANDARD MATERIALS

Bodies and Covers: Malleable Iron
Gaskets: Neoprene
Screws: Stainless Steel

STANDARD FINISH

Bodies and Covers: Hot-Dipped Galvanized

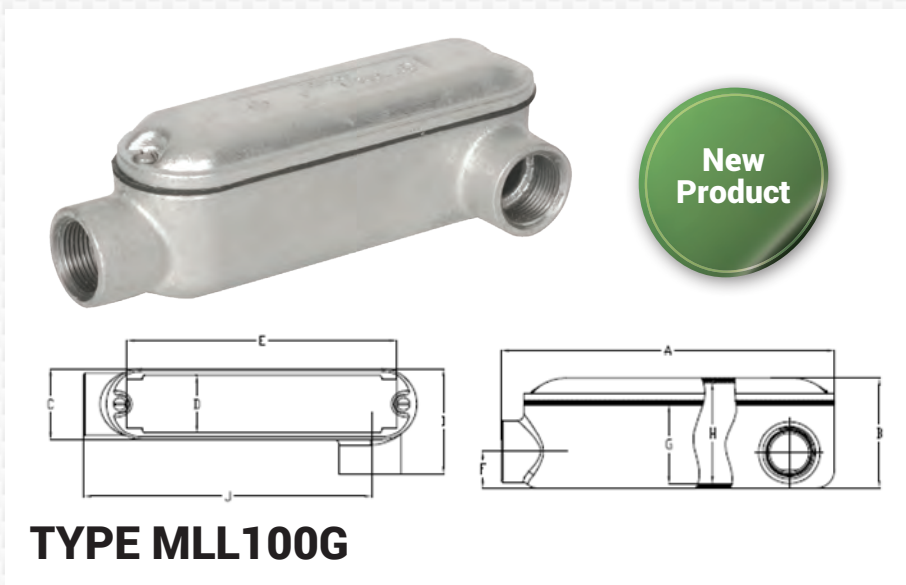

TYPE MLL100G

CATALOG NUMBER	TRADE SIZE	MAX WIRE SIZE	VOL. CU.IN.	UNIT PACK	MASTER PACK	LBS. / 100 PCS.	UPC#
MLL100G	1"	3 #4 AWG	31	-	1	179	10146
MLL125G	1-1/4"	3 #2 AWG	50	-	1	261	10147
MLL150G	1-1/2"	3 #1/0 AWG	93	-	1	459	10148
MLL200G	2"	3 #4/0 AWG	143	-	1	631	10149

CATALOG NUMBER	DIM A	DIM B	DIM C	DIM D	DIM E	DIM F	DIM G	DIM H	DIM I	DIM J	NUMBER OF COVER HOLES
MLL100G	8.94	2.80	2.36	1.85	6.61	0.93	1.84	2.48	3.27	7.76	2
MLL125G	11.16	3.44	2.44	1.93	7.60	1.14	2.28	3.13	3.39	9.94	2
MLL150G	13.27	3.88	3.15	2.56	9.68	1.34	2.57	3.46	4.00	11.69	2
MLL200G	17.02	4.43	3.15	2.52	13.09	1.63	3.14	4.02	4.13	15.45	2

MALLEABLE IRON/**HOT DIPPED GALVANIZED** MOGULS WITH COVER AND GASKET

FOR THREADED RIGID CONDUIT AND IMC

APPLICATION

- Larger body size facilitates pulling of large and heavy conductors. Specially designed raised cast covers provide additional wiring area.
- SEPCO Moguls are used for pulling straight, 45° or 90° angle turns and/or making taps and splices.

FEATURES

- Smooth, rounded integral bushing in each hub protects conductor insulation.
- Accurately tapered, tapered threads for tight, rigid joints and ground continuity.
- Covers have captive stainless steel screws to speed installation, prevent "freezing" of screws.
- Length Requirement: distance between centerline of each hub bushing (conduit stop) exceeds six times the trade diameter of the conduit per NEC 314.28(A)(2).

STANDARD MATERIALS

Bodies and Covers: Malleable Iron
Gaskets: Neoprene
Screws: Stainless Steel

STANDARD FINISH

Bodies and Covers: Hot-Dipped Galvanized

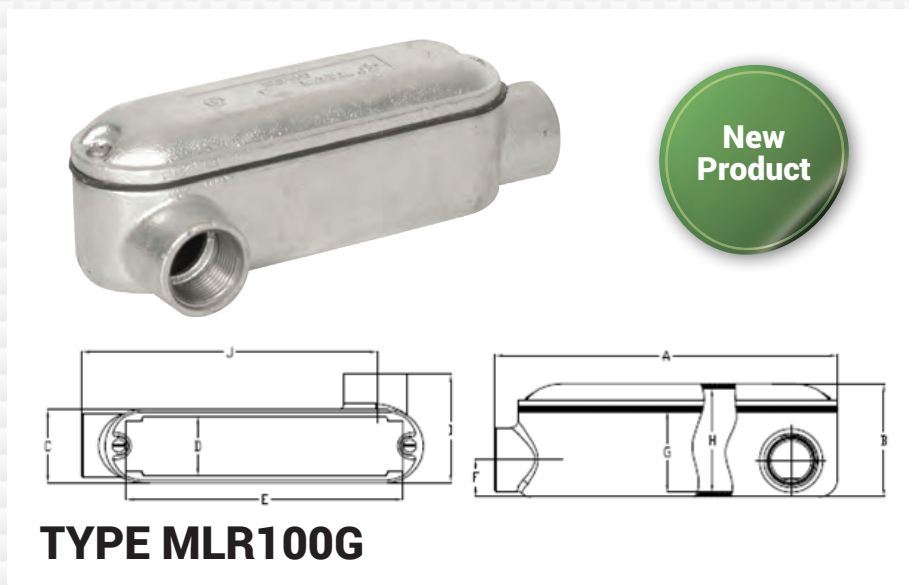

TYPE MLR100G

CATALOG NUMBER	TRADE SIZE	MAX WIRE SIZE	VOL. CU.IN.	UNIT PACK	MASTER PACK	LBS. / 100 PCS.	UPC#
MLR100G	1"	3 #4 AWG	31	-	1	176	10150
MLR125G	1-1/4"	3 #2 AWG	50	-	1	261	10151
MLR150G	1-1/2"	3 #1/0 AWG	93	-	1	435	10152
MLR200G	2"	3 #4/0 AWG	143	-	1	656	10153

CATALOG NUMBER	DIM A	DIM B	DIM C	DIM D	DIM E	DIM F	DIM G	DIM H	DIM I	DIM J	NUMBER OF COVER HOLES
MLR100G	8.94	2.80	2.36	1.85	6.61	0.93	1.84	2.48	3.27	7.76	2
MLR125G	11.16	3.44	2.44	1.93	7.60	1.14	2.28	3.13	3.39	9.94	2
MLR150G	13.27	3.88	3.15	2.56	9.68	1.34	2.57	3.46	4.00	11.69	2
MLR200G	17.02	4.43	3.15	2.52	13.09	1.63	3.14	4.02	4.13	15.45	2

MALLEABLE IRON/HOT DIPPED GALVANIZED MOGULS WITH COVER AND GASKET

FOR THREADED RIGID CONDUIT AND IMC

APPLICATION

- Larger body size facilitates pulling of large and heavy conductors. Specially designed raised cast covers provide additional wiring area.
- SEPCO Moguls are used for pulling straight, 45° or 90° angle turns and/or making taps and splices.

FEATURES

- Smooth, rounded integral bushing in each hub protects conductor insulation.
- Accurately tapered, tapered threads for tight, rigid joints and ground continuity.
- Covers have captive stainless steel screws to speed installation, prevent 'freezing' of screws.
- Length Requirement: distance between centerline of each hub bushing (conduit stop) exceeds six times the trade diameter of the conduit per NEC 314.28(A)(2).

STANDARD MATERIALS

Bodies and Covers: Malleable Iron
Gaskets: Neoprene
Screws: Stainless Steel

STANDARD FINISH

Bodies and Covers: Hot-Dipped Galvanized

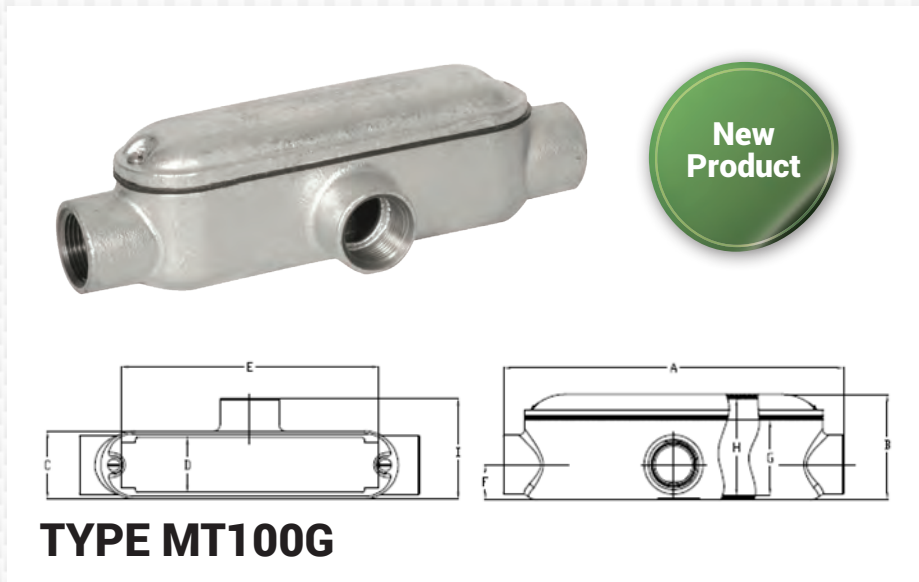

TYPE MT100G

CATALOG NUMBER	TRADE SIZE	MAX WIRE SIZE	VOL. CU.IN.	UNIT PACK	MASTER PACK	LBS. / 100 PCS.	UPC#
MT100G	1"	3 #4 AWG	31	-	1	187	10154
MT125G	1-1/4"	3 #2 AWG	50	-	1	263	10155
MT150G	1-1/2"	3 #1/0 AWG	93	-	1	447	10156
MT200G	2"	3 #4/0 AWG	143	-	1	651	10157

CATALOG NUMBER	DIM A	DIM B	DIM C	DIM D	DIM E	DIM F	DIM G	DIM H	DIM I	NUMBER OF COVER HOLES
MT100G	9.88	2.80	2.36	1.85	6.61	0.93	1.84	2.48	3.27	2
MT125G	12.64	3.44	2.44	1.93	7.60	1.14	2.28	3.13	3.39	2
MT150G	14.17	3.88	3.15	2.56	9.68	1.34	2.57	3.46	4.00	2
MT200G	18.15	4.43	3.15	2.52	13.09	1.63	3.14	4.02	4.02	2

MALLEABLE IRON/**HOT DIPPED GALVANIZED** THREADED CONDUIT BODIES

FOR THREADED RIGID CONDUIT AND IMC

APPLICATION

To provide access to conductors for pulling, splicing, and maintenance. Threaded for rigid conduit and IMC.

FEATURES

- Exclusive built-in rollers facilitate cable pulling from sizes 1 1/4" - 4"
- Tapered threaded hubs (NPT)
- Flat back design for easy mounting close to walls
- Suitable for use in concrete

STANDARD MATERIALS

Malleable Iron

STANDARD FINISH

Hot Dipped Galvanized/Zinc Plated



TYPE C1G

CATALOG NUMBER	TRADE SIZE	DIM A	DIM B	DIM C	MAX WIRE SIZE	VOL. CU.IN.	UNIT PACK	MASTER PACK	LBS. / 100 PCS.	UPC #
C Type										
C1G	1/2"	5.375	1.313	1.375	N/A	4.50	10	50	98	10158
C2G	3/4"	6.000	1.500	1.688	3 #6 AWG	7.50	10	50	118	10159
C3G	1"	7.063	1.813	1.875	3 #4 AWG	12.50	5	25	170	10160
C4G	1-1/4"	9.000	2.625	2.750	3 #2 AWG	32.30	—	10	309	10161
C5G	1-1/2"	9.000	2.625	2.813	3 #1/0 AWG	35.30	—	10	368	10162
C6G	2"	11.500	3.125	3.313	3 #4/0 AWG	73.00	—	5	553	10163
C7G	2-1/2"	15.000	4.313	3.875	3 #250 MCM	138.00	—	1	1216	10188
C8G	3"	15.125	4.313	4.750	3 #250 MCM	170.00	—	1	1437	10189
C9G	3-1/2"	18.125	4.875	5.625	3 #350 MCM	300.00	—	1	2210	10190
C10G	4"	18.125	4.875	5.625	3 #350 MCM	328.00	—	1	2321	10191

OPTIONAL FINISH

For Malleable Iron / Zinc Plated, please remove suffix 'G' from Hot Dipped Galvanized Catalog Number and see page 35.



TYPE LB1G

CATALOG NUMBER	TRADE SIZE	DIM A	DIM B	DIM C	MAX WIRE SIZE	VOL. CU.IN.	UNIT PACK	MASTER PACK	LBS. / 100 PCS.	UPC #
LB Type										
LB1G	1/2"	4.688	1.313	2.063	N/A	4.50	10	50	71	10164
LB2G	3/4"	5.375	1.500	2.250	3 #6 AWG	7.50	10	50	97	10165
LB3G	1"	6.188	1.813	2.625	3 #4 AWG	12.50	5	25	143	10166
LB4G	1-1/4"	8.125	2.625	2.750	3 #2 AWG	32.30	—	10	287	10167
LB5G	1-1/2"	8.125	2.625	2.813	3 #1/0 AWG	35.30	—	10	332	10168
LB6G	2"	10.500	3.125	4.438	3 #4/0 AWG	73.00	—	5	534	10169
LB7G	2-1/2"	13.625	4.313	5.375	3 #350 AWG	138.00	—	1	1105	10192
LB8G	3"	13.875	4.313	5.875	3 #350 AWG	170.00	—	1	1160	10193
LB9G	3-1/2"	16.250	5.625	6.875	3 #500 MCM	300.00	—	1	1989	10194
LB10G	4"	16.625	5.625	7.188	3 #500 MCM	328.00	—	1	2100	10195

MALLEABLE IRON/HOT DIPPED GALVANIZED THREADED CONDUIT BODIES

FOR THREADED RIGID CONDUIT AND IMC

APPLICATION

To provide access to conductors for pulling, splicing, and maintenance. Threaded for rigid conduit and IMC.

FEATURES

- Exclusive built-in rollers facilitate cable pulling from sizes 1 1/4" - 4"
- Tapered threaded hubs (NPT)
- Flat back design for easy mounting close to walls
- Suitable for use in concrete

STANDARD MATERIALS

Malleable Iron

STANDARD FINISH

Hot Dipped Galvanized/Zinc Plated



TYPE LL1G

New
Product

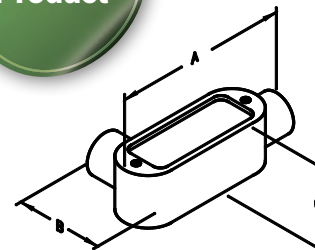

CATALOG NUMBER	TRADE SIZE	DIM A	DIM B	DIM C	MAX WIRE SIZE	VOL. CU.IN.	UNIT PACK	MASTER PACK	LBS. / 100 PCS.	UPC #
LL Type										
LL1G	1/2"	4.688	2.063	1.375	N/A	4.50	10	50	76	10170
LL2G	3/4"	5.375	2.250	1.688	3 #6 AWG	7.50	10	50	95	10171
LL3G	1"	6.188	2.625	1.875	3 #4 AWG	12.50	5	25	138	10172
LL4G	1-1/4"	8.125	2.750	2.750	3 #2 AWG	32.30	—	10	309	10173
LL5G	1-1/2"	8.125	3.500	2.813	3 #1/0 AWG	35.30	—	10	332	10174
LL6G	2"	10.500	4.125	3.313	3 #4/0 AWG	73.00	—	5	497	10175
LL7G	2-1/2"	13.625	4.688	3.875	3 #300 MCM	138.00	—	1	1105	10196
LL8G	3"	13.875	5.875	4.750	3 #350 MCM	170.00	—	1	1437	10197
LL9G	3-1/2"	16.250	6.125	5.625	3 #350 MCM	300.00	—	1	2321	10198
LL10G	4"	16.250	6.938	5.625	3 #350 MCM	328.00	—	1	2431	10199

OPTIONAL FINISH

For Malleable Iron / Zinc Plated, please remove suffix 'G' from Hot Dipped Galvanized Catalog Number and see page 36.



TYPE LR1G

New
Product

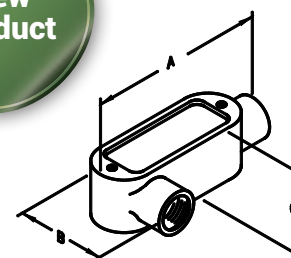

CATALOG NUMBER	TRADE SIZE	DIM A	DIM B	DIM C	MAX WIRE SIZE	VOL. CU.IN.	UNIT PACK	MASTER PACK	LBS. / 100 PCS.	UPC #
LR Type										
LR1G	1/2"	4.688	2.063	1.375	N/A	4.50	10	50	71	10176
LR2G	3/4"	5.375	2.250	1.688	3 #6 AWG	7.50	10	50	100	10177
LR3G	1"	6.188	2.625	1.875	3 #4 AWG	12.50	5	25	157	10178
LR4G	1-1/4"	8.125	2.750	2.750	3 #2 AWG	32.30	—	10	332	10179
LR5G	1-1/2"	8.125	2.813	2.813	3 #1/0 AWG	35.30	—	10	345	10180
LR6G	2"	10.500	4.438	3.313	3 #4/0 AWG	73.00	—	5	626	10181
LR7G	2-1/2"	13.625	5.375	3.875	3 #300 MCM	138.00	—	1	1105	10200
LR8G	3"	13.875	5.875	4.750	3 #350 MCM	170.00	—	1	1437	10201
LR9G	3-1/2"	16.250	6.875	5.625	3 #350 MCM	300.00	—	1	2321	10202
LR10G	4"	16.625	7.188	5.625	3 #350 MCM	328.00	—	1	2500	10203



SteelElectric
PRODUCTS

Ph: 718.259.6100 / 800.626.1223 Fax: 718.331.1874

www.sepco-usa.com

MALLEABLE IRON/HOT DIPPED GALVANIZED THREADED CONDUIT BODIES

FOR THREADED RIGID CONDUIT AND IMC

APPLICATION

To provide access to conductors for pulling, splicing, and maintenance. Threaded for rigid conduit and IMC.

FEATURES

- Exclusive built-in rollers facilitate cable pulling from sizes 1 1/4" - 4"
- Tapered threaded hubs (NPT)
- Flat back design for easy mounting close to walls
- Suitable for use in concrete

STANDARD MATERIALS

Malleable Iron

STANDARD FINISH

Hot Dipped Galvanized/Zinc Plated

OPTIONAL FINISH

For Malleable Iron / Zinc Plated, please remove suffix 'G' from Hot Dipped Galvanized Catalog Number and see page 37.



New Product

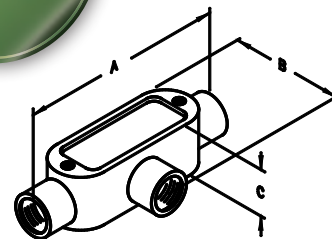

TYPE T1G

CATALOG NUMBER	TRADE SIZE	DIM A	DIM B	DIM C	MAX WIRE SIZE	VOL. CU.IN.	UNIT PACK	MASTER PACK	LBS. / 100 PCS.	UPC #
T Type										
T1G	1/2"	5.375	2.063	1.313	N/A	6.00	10	50	111	10182
T2G	3/4"	6.000	2.250	1.500	3 #6 AWG	9.50	10	50	137	10183
T3G	1"	7.063	2.625	1.813	3 #4 AWG	15.00	5	25	195	10184
T4G	1-1/4"	9.000	2.750	2.625	3 #2 AWG	33.00	—	10	332	10185
T5G	1-1/2"	9.000	3.500	2.625	3 #1/0 AWG	36.00	—	10	368	10186
T6G	2"	11.500	4.125	3.125	3 #1/0 AWG	75.00	—	5	663	10187
T7G	2-1/2"	15.000	5.688	4.313	3 #4/0 AWG	138.00	—	1	1271	10204
T8G	3"	15.125	5.875	4.313	3 #4/0 AWG	170.00	—	1	1547	10205
T9G	3-1/2"	18.125	6.813	4.875	3 #350 MCM	300.00	—	1	2542	10206
T10G	4"	18.125	7.188	4.875	3 #350 MCM	328.00	—	1	2542	10207

MALLEABLE IRON/HOT DIPPED GALVANIZED CONDUIT BODY COVERS

APPLICATION

Used with conduit bodies to cover opening.

FEATURES

- Supplied with Stainless Steel captive screws
- Sizes 2 1/2" thru 4" with raised dome affords additional wiring room

STANDARD MATERIALS

Malleable Iron

STANDARD FINISH

Hot Dipped Galvanized/Zinc Plated



New Product



TYPE 01MG

CATALOG NUMBER	TRADE SIZE	DIM A	DIM B	DIM C	UNIT PACK	MASTER PACK	LBS. / 100 PCS.	UPC #
01MG	1/2"	3.936	1.313	0.063	25	250	23	70224
02MG	3/4"	4.625	1.500	0.063	25	250	31	70225
03MG	1"	5.313	1.750	0.063	20	200	41	70226
04MG	1-1/4" - 1-1/2"	7.188	2.500	0.250	25	100	91	70227
05MG	2"	9.500	3.188	0.313	-	25	208	70228
06MG	2-1/2" - 3"	12.125	4.313	1.063	-	10	358	70229
07MG	3-1/2" - 4"	14.875	5.625	1.125	-	10	550	70230

MALLEABLE IRON/HOT DIPPED GALVANIZED INSULATED GROUNDING BUSHINGS

FOR THREADED RIGID CONDUIT AND IMC

New
Product

APPLICATION

Used with a locknut to terminate threaded rigid and IMC conduit to a box or enclosure and to provide a smooth pulling surface. Thermoplastic liner prevents damage to wire insulation. Liner rated at 150°C.

FEATURES

- The plastic liner won't chip, crack, swell or shrink. It resists corrosion, chemicals, and temperature extremes.
- Set-screw provided with each fitting locks bushing in any desired position.
- UL Listed for use with Copper or Aluminum Grounding Conductors.



TYPE 25BI4LG

STANDARD MATERIALS

Malleable Iron/Open side tin plated aluminum lug.

STANDARD FINISH

Hot Dipped Galvanized/Zinc Plated

Optional Lug: Available with copper lug; use suffix C instead of L. Example 21BI4CG.



OPTIONAL FINISH

For Malleable Iron / Zinc Plated, please remove suffix 'G' from Hot Dipped Galvanized Catalog Number and see page 57.

CATALOG NUMBER	TRADE SIZE	GROUNDING LUG CAPACITY	DIM A	DIM B	DIM C	UNIT PACK	MASTER PACK	LBS. / 100 PCS.	UPC #
Threaded									
20BI4LG	1/2"	#14 - #4	1.34	1.19	0.61	100	1000	7	10021
21BI4LG	3/4"	#14 - #4	1.47	1.45	0.64	50	500	11	10022
22BI4LG	1"	#14 - #4	1.63	1.76	0.72	25	250	15	10023
23BI4LG	1-1/4"	#14 - #4	1.80	2.10	0.74	25	250	18	10024
24BI4LG	1-1/2"	#14 - #4	2.11	2.33	0.80	25	250	23	10025
25BI4LG	2"	#14 - #4	2.34	2.79	0.85	25	250	28	10026
26BIOLG	2-1/2"	#14 - #2/0	2.84	3.33	1.10	-	10	57	10027
26BI4OLG	2-1/2"	#6 - #250MCM	3.47	3.33	1.10	-	10	70	10028
27BIOLG	3"	#14 - #2/0	3.11	3.87	1.10	-	10	73	10029
27BI4OLG	3"	#6 - #250MCM	3.74	3.87	1.10	-	10	85	10030
28BIOLG	3-1/2"	#14 - #2/0	3.38	4.42	1.10	-	10	88	10031
28BI4OLG	3-1/2"	#6 - #250MCM	4.02	4.42	1.10	-	10	90	10032
29BIOLG	4"	#14 - #2/0	3.62	4.89	1.10	-	10	118	10033
29BI4OLG	4"	#6 - #250MCM	4.25	4.89	1.10	-	10	121	10034
30BI4OLG	5"	#6 - #250MCM	4.80	6.00	1.13	-	10	165	10036
31BI4OLG	6"	#6 - #250MCM	5.46	7.31	1.13	-	10	203	10038



Steel Electric
PRODUCTS

Ph: 718.259.6100 / 800.626.1223 Fax: 718.331.1874

www.sepco-usa.com

MALLEABLE IRON/HOT DIPPED GALVANIZED WATERTIGHT CONDUIT HUBS

FOR THREADED RIGID CONDUIT AND IMC

APPLICATION

General Purpose Fitting.
Insulated Throat form with Bonding Screw.

FEATURES

- Male thread type
- Tapered female thread for rigid conduit and IMC
- Recessed O-ring seal assures watertight and dust tight connections.
- Insulated throat and bonding locknut is suitable for service entrance application.
- Suitable for use in hazardous locations as follows: Class I, Div. 2 Class II, Div. I, 2 Class III, Div. I, 2 Per NEC 501-4 (b), 502-4 (a), 503-3 (a)

MATERIAL/FINISH

Malleable Iron

STANDARD FINISH

Hot Dipped Galvanized/Zinc Plated

OPTIONAL FINISH

For Malleable Iron / Zinc Plated, please remove suffix 'G' from Hot Dipped Galvanized Catalog Number and see page 72.

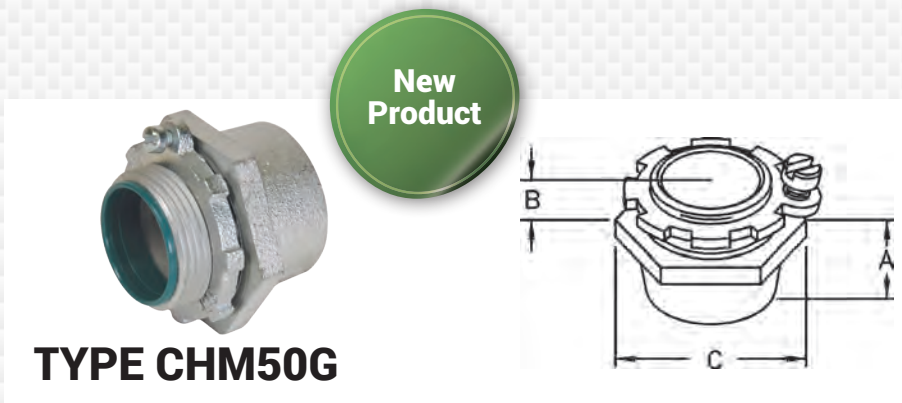

TYPE CHM50G

CATALOG NUMBER	TRADE SIZE	DIM A	DIM B	DIM C	UNIT PACK	MASTER PACK	LBS. / 100 PCS.	UPC #
CHM50G	1/2"	0.813	0.625	1.500	25	250	18	70910
CHM75G	3/4"	0.938	0.625	1.813	25	250	25	70911
CHM100G	1"	1.063	0.750	2.063	10	100	39	70912
CHM125G	1-1/4"	1.250	0.750	2.625	5	25	54	70913
CHM150G	1-1/2"	1.250	0.813	3.125	2	20	64	70914
CHM200G	2"	1.250	0.813	3.563	2	20	98	70915
CHM250G	2-1/2"	1.625	1.188	4.125	-	10	196	70916
CHM300G	3"	1.750	1.250	4.938	-	5	282	70917
CHM350G	3-1/2"	1.813	1.313	5.750	-	5	351	70918
CHM400G	4"	1.938	1.375	6.188	-	5	395	70919

MALLEABLE IRON/HOT DIPPED GALVANIZED 3-PIECE COUPLINGS

APPLICATION

Used to join two lengths of threaded conduit.

FEATURES

- Threaded (NPS) for rigid conduit and IMC
- Concrete tight

STANDARD MATERIALS

Malleable Iron

STANDARD FINISH

Hot Dipped Galvanized/Zinc Plated



OPTIONAL FINISH

For Malleable Iron / Zinc Plated, please remove suffix 'G' from Hot Dipped Galvanized Catalog Number and see page 76.



TYPE 1023G

CATALOG NUMBER	TRADE SIZE	DIM A	DIM B	DIM C	UNIT PACK	MASTER PACK	LBS. / 100 PCS.	UPC #
1022G	1/2"	1.38	1.36	1.36	20	200	26	10009
1023G	3/4"	1.63	1.58	1.58	10	100	37	10210
1024G	1"	1.81	1.89	1.89	-	20	55	10011
1025G	1-1/4"	2.19	2.38	2.38	-	20	111	10012
1026G	1-1/2"	2.31	2.83	2.83	-	10	172	10013
1027G	2"	2.44	3.29	3.29	-	10	203	10014
1028G	2-1/2"	3.19	4.08	4.08	2	10	327	10015
1029G	3"	3.31	4.67	4.67	2	10	442	10016
1030G	3-1/2"	3.50	5.07	5.07	1	5	608	10017
1031G	4"	3.75	5.75	5.75	1	5	718	10018
1005G	5"	3.69	6.88	7.50	-	1	1050	10019
1006G	6"	4.31	8.00	8.00	-	1	1250	10020

MALLEABLE IRON/MECHANICAL GALVANIZED STRAIGHT LIQUIDTIGHT CONNECTORS

FOR LIQUIDTIGHT FLEXIBLE METALLIC CONDUIT

APPLICATION

To secure, ground and seal Liquidtight Flexible Metal conduit, to boxes and enclosures

FEATURES

- Tapered threaded male hub NPT
- Compact, slim diameter with small turning radius
- Furnished with an insulated throat with steel locknut and sealing ring
- Liquidtight/Raintight/Oiltight
- Suitable for wet locations
- Long ferrule prevents pullout and tight bend conduit "pop-out"
- UL Listed liquidtight flexible metal conduit fittings are suitable for use in the following Hazardous Locations under NEC 501-4(b), 502-4(a)(2); Class I, Div.2; Class II, Div. 1 and 2; and Class III, Div. 1 and 2 and are suitable for grounding in sizes 3/8" through 1-1/2" under NEC 351-I

STANDARD MATERIALS

Malleable Iron/Steel Ferrule

STANDARD FINISH

Sizes 1/2" - 4" - Mechanical Galvanized
 Sizes 5" & 6" - Hot Dipped Galvanized

OPTIONAL FINISH

For Malleable Iron / Zinc Plated, please remove suffix 'MG' from Mechanical Galvanized Catalog Number and see page 124.



New Product

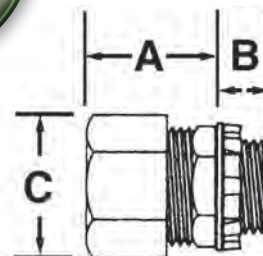

TYPE SLT27TMG

All Furnished with Insulated Throats

CATALOG NUMBER	TRADE SIZE	KO SIZE	I.D.	O.D.	DIM A	DIM B	DIM C	UNIT PACK	MASTER PACK	LBS. / 100 PCS.	UPC #
SLT27TMG	1/2"	1/2"	0.590	0.793	1.250	0.500	1.280	25	250	18	16305
SLT28TMG	3/4"	3/4"	0.785	1.020	1.280	0.520	1.550	10	100	29	16310
SLT29TMG	1"	1"	0.980	1.261	1.430	0.650	1.800	5	50	40	16315
SLT30TMG	1-1/4"	1-1/4"	1.330	1.605	1.500	0.660	2.250	5	50	56	16320
SLT31TMG	1-1/2"	1-1/2"	1.530	1.844	1.610	0.730	2.440	10	50	71	16325
SLT32TMG	2"	2"	1.995	2.337	1.760	0.750	2.970	5	25	100	16330
SLT33TMG	2-1/2"	2-1/2"	2.341	2.797	2.180	1.010	4.010	1	10	367	16335
SLT34TMG	3"	3"	2.939	3.418	2.500	1.150	4.180	1	10	461	16340
SLT60TMG	3-1/2"	3-1/2"	3.406	3.915	2.610	1.180	5.250	1	10	675	16345
SLT61TMG	4"	4"	3.882	4.411	2.740	1.250	5.780	1	5	797	16350
*SLT62TG	5"	5"	391.77	460.78	3.125	1.500	6.063	-	1	1047	16355
*SLT63TG	6"	6"	484.65	570.18	3.375	1.563	7.500	-	1	1381	16360

*Hot Dipped Galvanized



MALLEABLE IRON/**MECHANICAL GALVANIZED** 90° LIQUIDTIGHT CONNECTORS

FOR LIQUIDTIGHT FLEXIBLE METALLIC CONDUIT

APPLICATION

To secure, ground seal Liquidtight Flexible Metal conduit, to boxes and enclosures

FEATURES

- Tapered threaded male hub NPT
- Compact, slim diameter with small turning radius
- Furnished with an insulated throat with steel locknut and sealing ring
- Liquidtight/Raintight/Oiltight
- Suitable for wet locations
- Long ferrule prevents pullout and tight bend conduit "pop-out"
- UL Listed liquidtight flexible metal conduit fittings are suitable for use in the following Hazardous Locations under NEC 501-4(b), 502-4(a)(2); Class I, Div.2; Class II, Div. 1 and 2; and Class III, Div. 1 and 2 and are suitable for grounding in sizes 3/8" through 1-1/2" under NEC 351-I

STANDARD MATERIALS

Malleable Iron/Steel Ferrule

STANDARD FINISH

Sizes 1/2" - 2" - Mechanical Galvanized
 Sizes 2 1/2" - 4" - Hot Dipped Galvanized

OPTIONAL FINISH

For Malleable Iron / Zinc Plated, please remove suffix 'MG' from Mechanical Galvanized Catalog Number and see page 125.

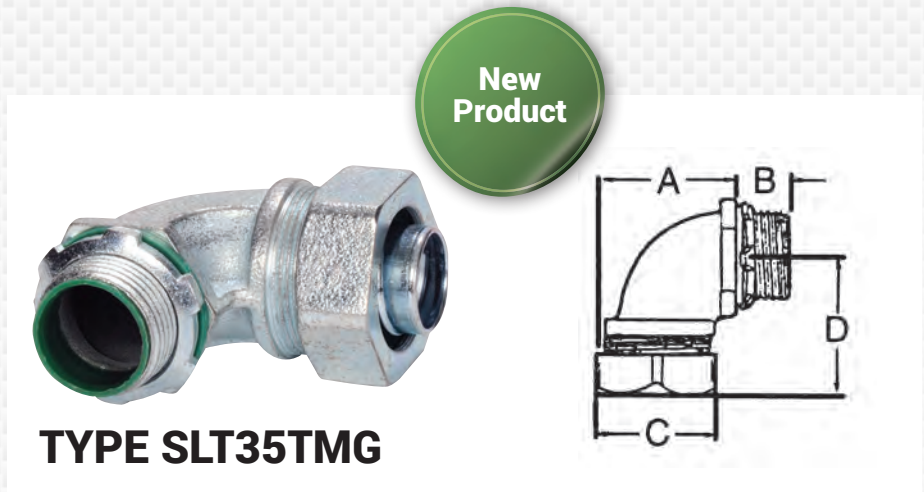

TYPE SLT35TMG

All Furnished with Insulated Throats

CATALOG NUMBER	TRADE SIZE	KO SIZE	I.D.	O.D.	DIM A	DIM B	DIM C	DIM D	UNIT PACK	MASTER PACK	LBS. / 100 PCS.	UPC #
SLT35TMG	1/2"	1/2"	0.590	0.793	1.43	0.50	1.28	1.37	10	100	31	16405
SLT36TMG	3/4"	3/4"	0.785	1.020	1.62	0.52	1.55	1.50	10	100	46	16410
SLT37TMG	1"	1"	0.980	1.261	1.93	0.65	1.80	1.81	5	50	77	16415
SLT38TMG	1-1/4"	1-1/4"	1.330	1.605	2.37	0.66	2.25	1.94	-	10	98	16420
SLT39TMG	1-1/2"	1-1/2"	1.530	1.844	2.68	0.73	2.44	2.40	-	10	124	16425
SLT40TMG	2"	2"	1.995	2.337	3.18	0.75	2.97	2.64	-	5	179	16430
*SLT65TG	2-1/2"	2-1/2"	2.341	2.797	8.31	1.01	4.01	7.81	-	1	847	16435
*SLT66TG	3"	3"	2.939	3.418	9.80	1.15	4.18	9.15	-	1	1243	16440
*SLT67TG	3-1/2"	3-1/2"	3.406	3.915	11.18	1.18	5.25	11.22	-	1	1914	16445
*SLT68TG	4"	4"	3.882	4.411	12.98	1.25	5.78	12.54	-	1	2399	16450

*Hot Dipped Galvanized



MALLEABLE IRON/MECHANICAL GALVANIZED 45° LIQUIDTIGHT CONNECTORS

FOR LIQUIDTIGHT FLEXIBLE METALLIC CONDUIT

APPLICATION

To secure, ground and seal Liquidtight Flexible Metal conduit to boxes and enclosures.

FEATURES

- Tapered threaded male hub NPT
- Compact, slim diameter with small turning radius
- Furnished with an insulated throat with steel locknut and sealing ring
- Liquidtight/Raintight/Oiltight
- Suitable for wet locations
- Long ferrule prevents pullout and tight bend conduit "pop-out"
- UL Listed liquidtight flexible metal conduit fittings are suitable for use in the following Hazardous Locations under NEC 501-4(b), 502-4(a)(2); Class I, Div.2; Class II, Div. 1 and 2; and Class III, Div. 1 and 2 and are suitable for grounding in sizes 3/8" through 1-1/2" under NEC 351-I

STANDARD MATERIALS

Malleable Iron/Steel Ferrule

STANDARD FINISH

Sizes 1/2" - 2" - Mechanical Galvanized
Sizes 2 1/2" - 4" - Hot Dipped Galvanized

OPTIONAL FINISH

For Malleable Iron / Zinc Plated, please remove suffix 'MG' from Mechanical Galvanized Catalog Number and see page 126.

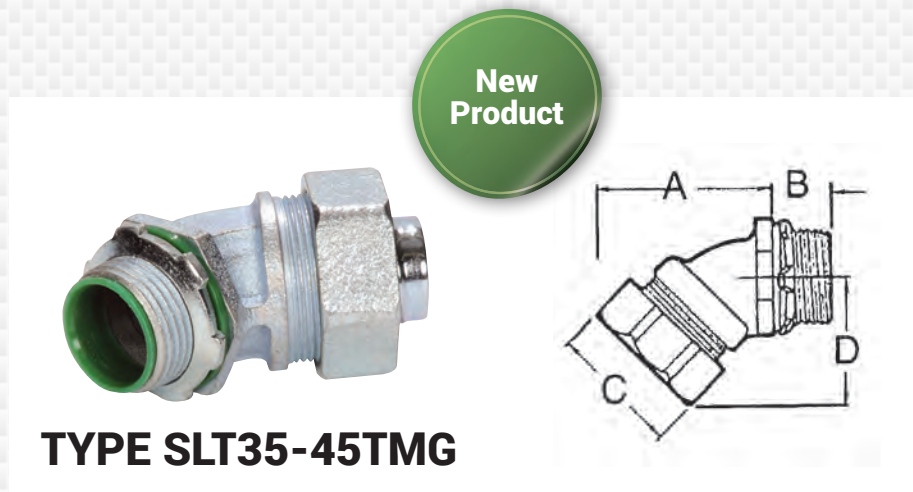

TYPE SLT35-45TMG

All Furnished with Insulated Throats

CATALOG NUMBER	TRADE SIZE	KO SIZE	I.D.	O.D.	DIM A	DIM B	DIM C	DIM D	UNIT PACK	MASTER PACK	LBS./100 PCS.	UPC #
SLT35-45TMG	1/2"	1/2"	0.590	0.793	1.25	0.50	1.28	1.51	10	100	29	16407
SLT36-45TMG	3/4"	3/4"	0.785	1.020	1.28	0.52	1.55	1.54	10	100	42	16412
SLT37-45TMG	1"	1"	0.980	1.261	1.43	0.65	1.80	1.81	5	50	66	16417
SLT38-45TMG	1-1/4"	1-1/4"	1.330	1.605	1.50	0.66	2.25	2.16	-	10	90	16422
SLT39-45TMG	1-1/2"	1-1/2"	1.530	1.844	1.61	0.73	2.44	2.43	-	10	112	16427
SLT40-45TMG	2"	2"	1.995	2.337	1.76	0.75	2.97	2.82	-	5	179	16432
*SLT65-45TG	2-1/2"	2-1/2"	2.341	2.797	2.18	1.01	4.01	4.41	-	1	582	16437
*SLT66-45TG	3"	3"	2.939	3.418	2.50	1.15	4.18	5.50	-	1	869	16442
*SLT67-45TG	3-1/2"	3-1/2"	3.406	3.915	2.61	1.18	5.25	5.93	-	1	1296	16447
*SLT68-45TG	4"	4"	3.882	4.411	2.74	1.25	5.78	8.34	-	1	1539	16452

*Hot Dipped Galvanized



MALLEABLE IRON/**MECHANICAL GALVANIZED** STRAIGHT LIQUIDTIGHT CONNECTORS

WITH COPPER LUGS FOR LIQUIDTIGHT FLEXIBLE METALLIC CONDUIT

APPLICATION

Connects conduit and terminates bonding conductor run externally across liquidtight conduit.

FEATURES

- Tapered threaded male hub NPT
- Compact, slim diameter with small turning radius
- Furnished with Insulated throat, steel locknut, and sealing ring
- Liquidtight/Raintight/Oiltight
- Suitable for grounding & wet locations
- Long ferrule prevents pullout and tight bend conduit 'pop-out'
- UL Listed liquidtight flexible metal conduit fittings are suitable for use in the following Hazardous Locations under NEC 501-4(b), 502-4(a)(2); Class I, Div.2; Class II, Div. 1 and 2; and Class III, Div. 1 and 2 and are suitable for grounding in sizes 3/8" through 1-1/2" under NEC 351-I

STANDARD MATERIALS

Malleable Iron/Steel Ferrule/Copper Grounding Lug

STANDARD FINISH

Sizes 1/2" - 4" - Mechanical Galvanized
 Sizes 5" & 6" - Hot Dipped Galvanized

OPTIONAL FINISH

For Malleable Iron / Zinc Plated, please remove suffix 'MG' from Mechanical Galvanized Catalog Number and see page 130.

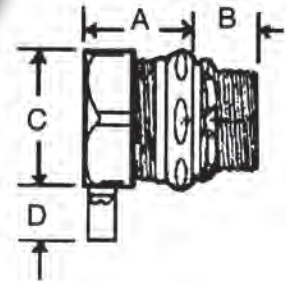

TYPE SLT27CLTMG

All Furnished with Insulated Throats

CATALOG NUMBER	TRADE SIZE	LUG SIZE	I.D.	O.D.	DIM A	DIM B	DIM C	DIM D	UNIT PACK	MASTER PACK	LBS./ 100 PCS.	UPC #
SLT27CLTMG	1/2"	#4-#14	0.590	0.793	1.25	0.50	1.28	0.75	25	250	20	50503
SLT28CLTMG	3/4"	#4-#14	0.785	1.020	1.28	0.52	1.55	0.75	10	100	31	50506
SLT29CLTMG	1"	#4-#14	0.980	1.261	1.43	0.65	1.80	0.75	5	50	42	50509
SLT30CLTMG	1-1/4"	#4-#14	1.330	1.605	1.50	0.66	2.25	0.75	5	50	57	50512
SLT31CLTMG	1-1/2"	#4-#14	1.530	1.844	1.61	0.73	2.44	0.75	10	50	73	50515
SLT32CLTMG	2"	#4-#14	1.995	2.337	1.76	0.75	2.97	0.75	5	25	101	50518
SLT33CLTMG	2-1/2"	#1/0-#8	2.341	2.797	2.18	1.01	4.01	1.13	1	10	373	50521
SLT34CLTMG	3"	#1/0-#8	2.939	3.418	2.50	1.15	4.18	1.13	1	10	465	50524
SLT60CLTMG	3-1/2"	#3/0-#6	3.406	3.915	2.61	1.18	5.25	1.50	1	10	686	50527
SLT61CLTMG	4"	#3/0-#6	3.882	4.411	2.74	1.25	5.78	1.50	1	5	807	50530
*SLT62CLTG	5"	#6-#250 MCM	391.77	460.78	3.13	1.50	6.06	1.69	-	1	1058	50531
*SLT63CLTG	6"	#6-#250 MCM	484.65	570.18	3.13	1.56	7.50	1.69	-	1	1395	50532

*Hot Dipped Galvanized

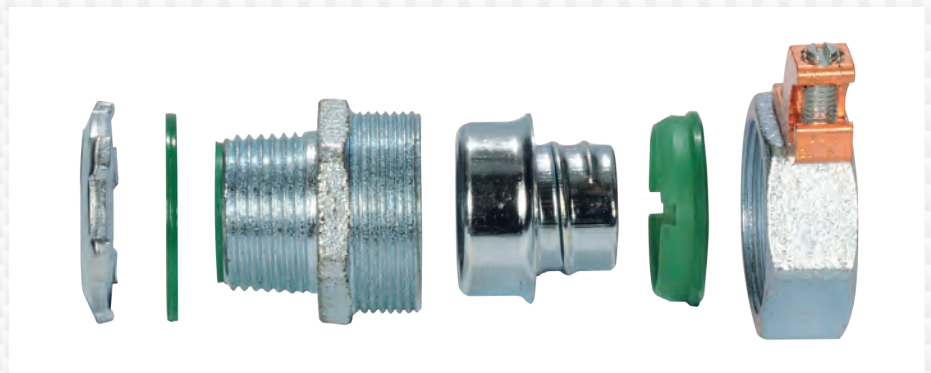

MALLEABLE IRON/MECHANICAL GALVANIZED 90° LIQUIDTIGHT CONNECTORS

WITH COPPER LUGS FOR LIQUIDTIGHT FLEXIBLE METALLIC CONDUIT

APPLICATION

Connects conduit and terminates bonding conductor run externally across liquidtight conduit.

FEATURES

- Tapered threaded male hub NPT
- Compact, slim diameter with small turning radius
- Furnished with Insulated throat, steel locknut, and sealing ring
- Liquidtight/Raintight/Oiltight
- Suitable for grounding and wet locations
- Long ferrule prevents pullout and tight bend conduit 'pop-out'
- UL Listed liquidtight flexible metal conduit fittings are suitable for use in the following Hazardous Locations under NEC 501-4(b), 502-4(a)(2); Class I, Div.2; Class II, Div. 1 and 2; and Class III, Div. 1 and 2 and are suitable for grounding in sizes 3/8" through 1-1/2" under NEC 351-I

STANDARD MATERIALS

Malleable Iron/Steel Ferrule/Copper Grounding Lug

STANDARD FINISH

Sizes 1/2" - 2" - Mechanical Galvanized
 Sizes 2 1/2" - 4" - Hot Dipped Galvanized

OPTIONAL FINISH

For Malleable Iron / Zinc Plated, please remove suffix 'MG' from Mechanical Galvanized Catalog Number and see page 131.



TYPE SLT35CLTMG

All Furnished with Insulated Throats

CATALOG NUMBER	TRADE SIZE	LUG SIZE	I.D.	O.D.	DIM A	DIM B	DIM C	DIM D	DIM E	UNIT PACK	MASTER PACK	LBS./100 PCS.	UPC #
SLT35CLTMG	1/2"	#4-#14	0.590	0.793	1.43	0.50	1.28	1.37	0.75	10	100	20	16405
SLT36CLTMG	3/4"	#4-#14	0.785	1.020	1.62	0.52	1.55	1.50	0.75	10	100	31	16410
SLT37CLTMG	1"	#4-#14	0.980	1.261	1.93	0.65	1.80	1.81	0.75	5	50	42	16415
SLT38CLTMG	1-1/4"	#4-#14	1.330	1.605	2.37	0.66	2.25	1.94	0.75	-	10	57	16420
SLT39CLTMG	1-1/2"	#4-#14	1.530	1.844	2.68	0.73	2.44	2.40	0.75	-	10	73	16425
SLT40CLTMG	2"	#4-#14	1.995	2.337	3.18	0.75	2.97	2.64	0.75	-	5	101	16430
*SLT65CLTG	2-1/2"	#1/0-#8	2.341	2.797	8.31	1.01	4.01	7.81	1.13	-	1	373	16435
*SLT66CLTG	3"	#1/0-#8	2.939	3.418	9.80	1.15	4.18	9.15	1.13	-	1	465	16440
*SLT67CLTG	3-1/2"	#3/0-#6	3.406	3.915	11.18	1.18	5.25	11.22	1.50	-	1	686	16445
*SLT68CLTG	4"	#3/0-#6	3.882	4.411	12.93	1.25	5.78	12.54	1.50	-	1	807	16450

*Hot Dipped Galvanized



MALLEABLE IRON/**MECHANICAL GALVANIZED** 45° LIQUIDTIGHT CONNECTORS

WITH COPPER LUGS FOR LIQUIDTIGHT FLEXIBLE
METALLIC CONDUIT

APPLICATION

Connects conduit and terminates bonding conductor run externally across liquidtight conduit.

FEATURES

- Tapered threaded male hub NPT
- Compact, slim diameter with small turning radius
- Furnished with Insulated throat, steel locknut, and sealing ring
- Liquidtight/Raintight/Oiltight
- Suitable for grounding
- Long ferrule prevents pull-out and tight bend conduit "pop-out"
- UL Listed liquidtight flexible metal conduit fittings are suitable for use in the following Hazardous Locations under NEC 501-4(b), 502-4(a)(2); Class I, Div.2; Class II, Div. 1 and 2; and Class III, Div. 1 and 2 and are suitable for grounding in sizes 3/8" through 1-1/2" under NEC 351-I.

STANDARD MATERIALS

Malleable Iron/Steel Ferrule/Copper Grounding Lug

STANDARD FINISH

Sizes 1/2" - 2" - Mechanical Galvanized
Sizes 2 1/2" - 4" - Hot Dipped Galvanized

OPTIONAL FINISH

For Malleable Iron / Zinc Plated, please remove suffix "MG" from Mechanical Galvanized Catalog Number and see page 132.



TYPE SLT35-45CLTMG

All Furnished with Insulated Throats

CATALOG NUMBER	TRADE SIZE	LUG SIZE	I.D.	O.D.	DIM A	DIM B	DIM C	DIM D	DIM E	UNIT PACK	MASTER PACK	LBS./ 100 PCS.	UPC #
SLT35-45CLTMG	1/2"	#4-#14	0.590	0.793	1.64	0.50	1.28	1.51	0.75	10	100	20	50569
SLT36-45CLTMG	3/4"	#4-#14	0.785	1.020	1.68	0.52	1.55	1.54	0.75	10	100	31	50572
SLT37-45CLTMG	1"	#4-#14	0.980	1.261	2.16	0.65	1.80	1.81	0.75	5	50	42	50575
SLT38-45CLTMG	1-1/4"	#4-#14	1.330	1.605	2.50	0.66	2.25	2.16	0.75	-	10	57	50578
SLT39-45CLTMG	1-1/2"	#4-#14	1.530	1.844	3.10	0.73	2.44	2.43	0.75	-	10	73	50581
SLT40-45CLTMG	2"	#4-#14	1.995	2.337	3.28	0.75	2.97	2.82	0.75	-	5	101	50584
*SLT65-45CLTG	2-1/2"	#1/0-#8	2.341	2.797	6.67	1.01	4.01	4.41	1.13	-	1	373	50587
*SLT66-45CLTG	3"	#1/0-#8	2.939	3.418	8.01	1.15	4.18	5.50	1.13	-	1	465	50590
*SLT67-45CLTG	3-1/2"	#3/0-#6	3.406	3.915	9.55	1.18	5.25	5.93	1.50	-	1	686	50593
*SLT68-45CLTG	4"	#3/0-#6	3.882	4.411	10.64	1.25	5.78	8.34	1.50	-	1	807	50596

*Hot Dipped Galvanized



MALLEABLE IRON/HOT DIPPED GALVANIZED ONE-HOLE STRAPS

FOR THREADED RIGID CONDUIT AND IMC

APPLICATION

Click-on type one-hole straps for rigid conduit or IMC. Provides support for the conduits, as required by the National Electrical Code.

FEATURES

- Heavy Duty Casting

STANDARD MATERIALS

Malleable Iron

STANDARD FINISH

Hot Dipped Galvanized/Zinc Plated

OPTIONAL FINISH

For Malleable Iron / Zinc Plated, please remove suffix 'G' from Hot Dipped Galvanized Catalog Number and see page 86.



TYPE 133G

New Product

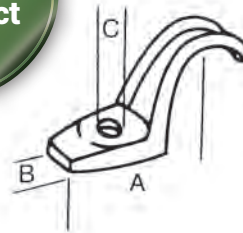

CATALOG NUMBER	TRADE SIZE	DIM A	DIM B	DIM C	UNIT PACK	MASTER PACK	LBS. / 100 PCS.	UPC #
132G	1/2"	1.437	0.625	0.312	100	1000	6	70200
133G	3/4"	1.750	0.750	0.312	100	1000	8	70201
134G	1"	2.125	0.937	0.312	50	500	9	70202
135G	1-1/4"	2.375	1.062	0.437	-	100	22	70203
136G	1-1/2"	2.750	1.062	0.500	-	50	32	70204
137G	2"	3.937	1.250	0.562	-	50	44	70205
138G	2-1/2"	3.937	1.250	0.562	-	25	66	70206
139G	3"	5.187	1.750	0.562	-	10	159	70207
141G	3-1/2"	5.562	2.125	0.750	-	10	185	70208
148G	4"	6.500	2.250	0.750	-	10	221	70209
150G	5"	10.040	2.750	0.750	-	5	369	70210
152G	6"	12.500	3.130	0.750	-	5	631	70211

MALLEABLE IRON/HOT DIPPED GALVANIZED CLAMP BACK SPACERS

FOR THREADED RIGID CONDUIT AND IMC

APPLICATION

Provides space between conduit and mounting surface, for use with malleable iron or aluminum straps.

FEATURES

- Heavy Duty Casting
- Can be used with one hole straps.

STANDARD MATERIALS

Malleable Iron

STANDARD FINISH

Hot Dipped Galvanized/Zinc Plated

OPTIONAL FINISH

For Malleable Iron / Zinc Plated, please remove suffix 'G' from Hot Dipped Galvanized Catalog Number and see page 86.



TYPE 901G

New Product

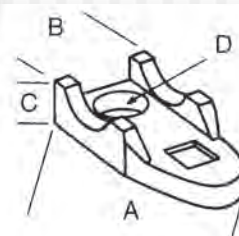

CATALOG NUMBER	TRADE SIZE	DIM A	DIM B	DIM C	DIM D	UNIT PACK	MASTER PACK	LBS. / 100 PCS.	UPC #
900G	1/2"	2.000	1.000	0.500	0.313	100	1000	8	70212
901G	3/4"	2.300	1.060	0.500	0.313	100	500	12	70213
902G	1"	2.320	1.250	0.560	0.375	50	500	16	70214
903G	1-1/4"	3.430	1.870	0.750	0.438	50	250	22	70215
904G	1-1/2"	3.810	1.870	0.810	0.438	-	25	35	70216
905G	2"	4.750	1.920	1.000	0.563	-	25	51	70217
906G	2-1/2"	5.750	2.410	1.000	0.563	-	25	81	70218
907G	3"	6.780	2.620	1.000	0.563	-	25	83	70219
908G	3-1/2"	7.120	2.870	1.060	0.750	-	20	148	70220
909G	4"	8.830	3.060	1.060	0.750	-	10	199	70221
910G	5"	10.125	3.750	1.188	0.750	-	10	344	70222
911G	6"	12.188	4.000	1.500	0.750	-	10	419	70223

MALLEABLE IRON/**HOT DIPPED GALVANIZED** CABLE SUPPORTS-BODY ONLY

FOR THREADED RIGID CONDUIT AND IMC

APPLICATION

For supporting non-armored electrical cables in vertical conduit risers

FEATURES

- Threaded for Rigid Conduit and IMC
- The fastest and easiest type cable support to install
- Equipped with tapered phenolic bushing

STANDARD MATERIAL

Malleable Iron

STANDARD FINISH

Hot Dipped Galvanized



TYPE CSB-200

CATALOG NUMBER	TRADE SIZE	DIM A	DIM B	DIM C	UNIT PACK	MASTER PACK	LBS. / 100 PCS.	UPC #
CSB-200	2"	2.375	2.625	2"-8 NPSM	1	10	175	50035
CSB-250	2-1/2"	2.520	3.610	2 1/2"-8 NPSM	1	10	225	50036
CSB-300	3"	2.750	4.290	3"-8 NPSM	1	10	282	50037
CSB-350	3-1/2"	3.100	4.960	3 1/2"-8 NPSM	1	5	335	50038
CSB-400	4"	3.100	5.520	4"-8 NPSM	1	5	470	50049



RIGID-IMC FITTINGS

FS and FD Device Boxes - Single Gang.....	26	Conduit Capped Bushings.....	66
FS and FD Device Box Covers - Single Gang.....	27	Conduit Metal Pennies.....	66
FS and FD Device Boxes - Double Gang.....	28	Phenolic Insulating Couplings.....	67
FS and FD Device Box Covers - Double Gang.....	29	Plastic Bushings.....	68
Malleable Iron/Hot Dipped Galvanized Moguls with Cover, Gasket & Rollers.....	30	Offset Conduit Nipples.....	69
Malleable Iron/Hot Dipped Galvanized Moguls with Cover and Gasket.....	32	Zinc Conduit Nipples.....	70
Malleable Iron Threaded Conduit Bodies.....	35	Malleable Iron Conduit Nipples.....	71
Malleable Iron/Hot Dipped Galvanized Threaded Conduit Bodies.....	38	Malleable Iron Watertight Conduit Hubs.....	72
Form 7 Conduit Bodies.....	41	Malleable Iron/Hot Dipped Galvanized Watertight Conduit Hubs.....	72
Aluminum Threaded Conduit Bodies.....	44	Watertight Conduit Hubs.....	73
Aluminum Threaded Conduit Bodies with Cover and Gasket.....	47	Standard Conduit Locknuts.....	74
Aluminum Combination Conduit Bodies with Cover and Gasket.....	50	Malleable Iron 3-Piece Couplings.....	76
Conduit Body Covers.....	53	Malleable Iron/Hot Dipped Galvanized 3-Piece Couplings.....	76
Malleable Iron Conduit Body Covers.....	54	Malleable Iron Rigid Compression Connectors.....	77
Malleable Iron/Hot Dipped Galvanized Conduit Body Covers.....	54	Malleable Iron Rigid Compression Couplings.....	78
Neoprene Gaskets.....	55	Malleable Iron Rigid Set-Screw Connectors.....	79
Form 7 Conduit Body Covers.....	56	Malleable Iron Rigid Set-Screw Couplings.....	80
Malleable Iron Insulated Grounding Bushings.....	57	Combination Couplings.....	81
Malleable Iron/Hot Dipped Galvanized Insulated Grounding Bushings.....	58	Malleable Iron 90° Pull Elbows.....	83
Malleable Iron Threadless Insulated Grounding Bushings.....	59	Zinc 90° Pull Elbows.....	84
Specification Grade Bronze Insulated Grounding Bushing.....	60	Malleable Iron Split Couplings.....	85
Zinc Insulated Grounding Bushings.....	61	Malleable Iron One-Hole Straps.....	86
Malleable Iron Insulated Bushings.....	62	Malleable Iron Clamp Back Spacers.....	86
Zinc Insulated Bushings.....	63	Malleable Iron/Hot Dipped Galvanized One-Hole Straps.....	87
Malleable Iron and Zinc Conduit Bushings.....	64	Malleable Iron/Hot Dipped Galvanized Clamp Back Spacers.....	87
Malleable Iron/Hot Dipped Galvanized Cable Supports-Body Only.....	65	Steel One-Hole Straps and Steel Two-Hole Straps.....	88
		Conduit Reducer Bushings.....	89
		Conduit Hex Reducer Bushings.....	90
		Conduit Reducing Washers.....	91
		Pipe Plugs.....	92
		Floor Flanges and Enlargers.....	93

FS AND FD DEVICE BOXES - SINGLE GANG

FOR THREADED RIGID CONDUIT AND IMC

APPLICATION

Accommodates wiring devices and provides opening to splice, tap or pull conductors.

FEATURES

- Tapered threaded hubs (NPT) with integral bushing
- Internal grounding screw
- Suitable for use in wet locations when used with gasketed covers
- Surface mounting lugs

STANDARD MATERIALS

Malleable Iron

STANDARD FINISH

Zinc Plated



OPTIONAL FINISH

For additional corrosion protection, specify Hot Dipped Galvanized. Add suffix 'G' to Malleable Iron catalog number. Example FD-50G. Please call factory for pricing and availability.

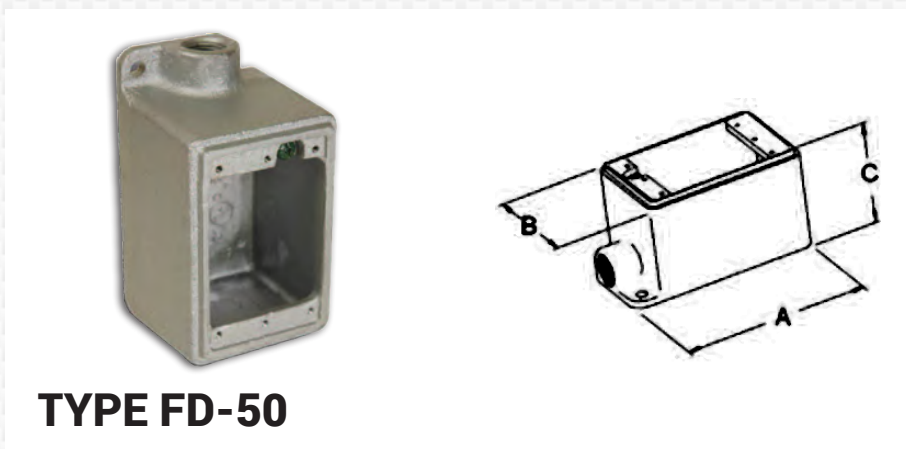

TYPE FD-50

CATALOG NUMBER	TRADE SIZE	DIM A	DIM B	DIM C	UNIT PACK	MASTER PACK	LBS. / 100 PCS.	UPC #
FS-50	1/2"	5.250	2.938	2.125	1	5	221	90116
FS-75	3/4"	5.250	2.938	2.125	1	5	233	90117
FS-100	1"	5.250	2.938	2.125	1	5	242	90118
FD-50	1/2"	5.250	3.000	2.875	1	5	272	90119
FD-75	3/4"	5.250	3.000	2.875	1	5	278	90120
FD-100	1"	5.250	3.000	2.875	1	5	283	90121

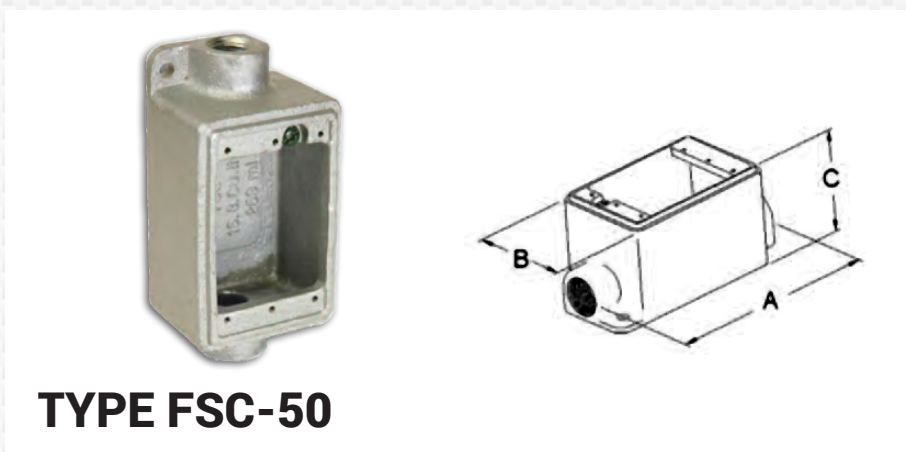

TYPE FSC-50

CATALOG NUMBER	TRADE SIZE	DIM A	DIM B	DIM C	UNIT PACK	MASTER PACK	LBS. / 100 PCS.	UPC #
FSC-50	1/2"	6.063	2.938	2.125	1	5	234	90122
FSC-75	3/4"	6.063	2.938	2.125	1	5	240	90123
FSC-100	1"	6.063	2.938	2.125	1	5	250	90124
FDC-50	1/2"	6.063	3.000	2.875	1	5	293	90125
FDC-75	3/4"	6.063	3.000	2.875	1	5	305	90126
FDC-100	1"	6.063	3.000	2.875	1	5	313	90127

FS AND FD DEVICE BOX COVERS - SINGLE GANG

FEATURES

- Blank cover with gasket for enclosing splices and taps where device is not used
- For square handle general use snap or toggle switches guarded
- For standard and 3-pole, 2 wire grounding type duplex convenience receptacles
- Each cover individually bagged and supplied with screws

STANDARD MATERIALS

Steel

STANDARD FINISH

Zinc Plated



CATALOG NUMBER	TYPE	UNIT PACK	MASTER PACK	LBS. / 100 PCS.	UPC #
FSFDCS1	Blank	5	50	18	10110
FSFDCS2	Toggle Switch	5	50	17	10111
FSFDCS3	Duplex Receptacle	5	50	14	10112
FSFDCS4	Ground Fault Interrupter (GFI)	5	50	13	10113

STANDARD MATERIALS

Malleable Iron

STANDARD FINISH

Zinc Plated



CATALOG NUMBER	TYPE	UNIT PACK	MASTER PACK	LBS. / 100 PCS.	UPC #
FSFDCM1	Blank	5	50	56	10114
FSFDCM2	Toggle Switch	5	50	63	10115
FSFDCM3	Duplex Receptacle	5	50	54	10116

OPTIONAL FINISH

For additional corrosion protection, specify Hot Dipped Galvanized. Add suffix 'G' to Malleable Iron catalog number. Example FSFDCM1G. Please call factory for pricing and availability.

STANDARD MATERIALS

Neoprene Gasket

CATALOG NUMBER	TYPE	UNIT PACK	MASTER PACK	LBS. / 100 PCS.	UPC #
FSFDGC	Gasket	10	100	3	10117

FS AND FD DEVICE BOXES - DOUBLE GANG

FOR THREADED RIGID CONDUIT AND IMC

APPLICATION

Accommodates wiring devices and provides opening to splice, tap or pull conductors.

FEATURES

- Tapered threads (NPT) with integral bushings
- 2 grounding screws located on top and bottom for easy access
- Suitable for use in wet locations when used with FSFD2-CS1 and FSFD-CG
- Gray Iron is suitable for concrete use

STANDARD MATERIALS

Gray Iron

STANDARD FINISH

Zinc Plated



New Product

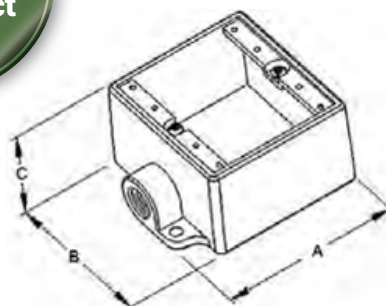

TYPE FD2-50

CATALOG NUMBER	TRADE SIZE	DIM A	DIM B	DIM C	UNIT PACK	MASTER PACK	LBS. / 100 PCS.	UPC #
FS2-50	1/2"	5.125	5.625	2.063	1	10	297	54006
FS2-75	3/4"	5.125	5.625	2.063	1	10	300	54007
FS2-100	1"	5.125	5.625	2.063	1	10	317	54008
FD2-50	1/2"	5.125	5.625	2.875	1	10	369	54000
FD2-75	3/4"	5.125	5.625	2.875	1	10	375	54001
FD2-100	1"	5.125	5.625	2.875	1	10	376	54002

OPTIONAL FINISH

Also available in Hot Dipped Galvanized finish upon request. Add suffix 'G' to Gray Iron catalog number. Example: FD2-50G. Please call factory for pricing and availability.

New Product

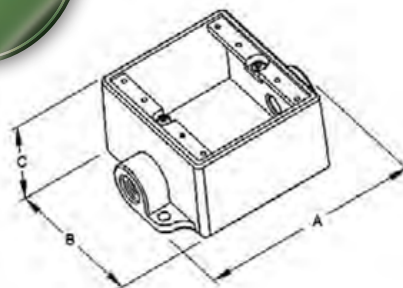

TYPE FSC2-50

CATALOG NUMBER	TRADE SIZE	DIM A	DIM B	DIM C	UNIT PACK	MASTER PACK	LBS. / 100 PCS.	UPC #
FSC2-50	1/2"	5.938	5.625	2.063	1	10	302	54009
FSC2-75	3/4"	5.938	5.625	2.063	1	10	315	54010
FSC2-100	1"	5.938	5.625	2.063	1	10	335	54011
FDC2-50	1/2"	5.938	5.625	2.875	1	10	405	54003
FDC2-75	3/4"	5.938	5.625	2.875	1	10	415	54004
FDC2-100	1"	5.938	5.625	2.875	1	10	418	54005

FS AND FD DEVICE BOX COVERS - DOUBLE GANG

FOR THREADED RIGID CONDUIT AND IMC

FEATURES

- Each cover comes with captive screws
- FSFD-CS1 - Raintight if used with FSFD2-CG

STANDARD MATERIALS

Steel

STANDARD FINISH

Zinc Plated

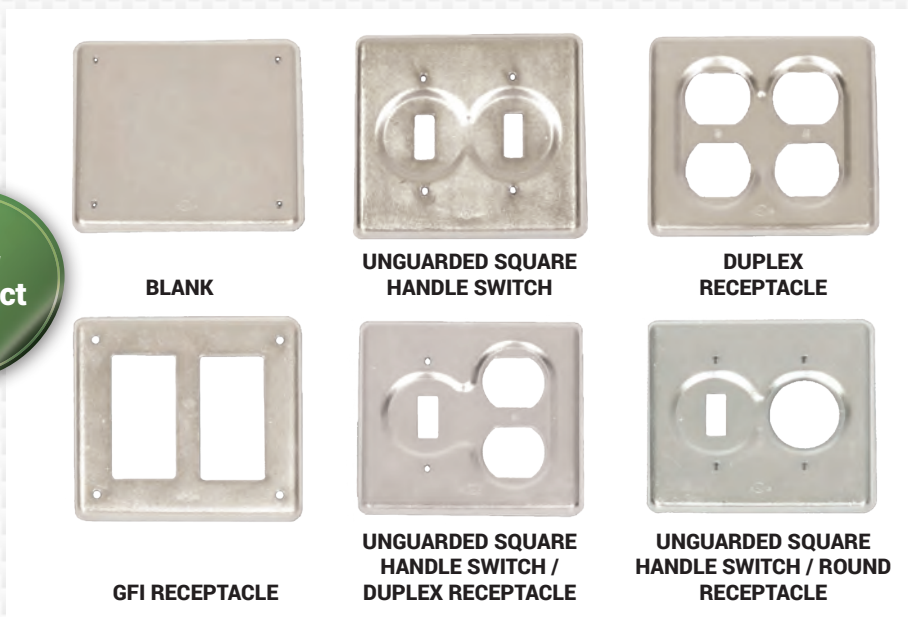

CATALOG NUMBER	TYPE	UNIT PACK	MASTER PACK	LBS. / 100 PCS.	UPC #
FSFD2-CS1	Blank	-	5	40	50415
FSFD2-CS2	Unguarded Square Handle Switch	-	10	37	50418
FSFD2-CS3	Duplex Receptacle	-	10	30	50416
FSFD2-CS4	GFI Receptacle	-	5	26	50417
FSFD2-CS5	Unguarded Square Handle Switch/ Duplex Receptacle	-	10	33	50420
FSFD2-CS6	Unguarded Square Handle Switch/ Round Receptacle	-	10	35	50419

FEATURES

- Each cover comes with captive screws
- FSFD-CM1 - Raintight if used with FSFD2-CG

STANDARD MATERIALS

Gray Iron

STANDARD FINISH

Zinc Plated

OPTIONAL FINISH

Also available in Hot Dipped Galvanized finish upon request. Add suffix 'G' to Gray Iron catalog number. Example: FSFD-CM1G. Please call factory for pricing and availability.

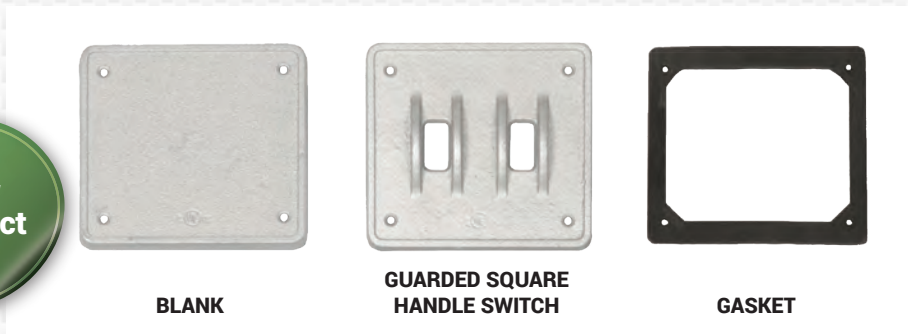

CATALOG NUMBER	TYPE	UNIT PACK	MASTER PACK	LBS. / 100 PCS.	UPC #
FSFD2-CM1	Blank	1	10	89	54013
FSFD2-CM2	Guarded Square Handle Switch	1	10	94	54014

STANDARD MATERIALS

Neoprene Rubber

CATALOG NUMBER	TYPE	UNIT PACK	MASTER PACK	LBS. / 100 PCS.	UPC #
FSFD2-CG	Gasket	-	20	4	54012

MALLEABLE IRON/**HOT DIPPED GALVANIZED** MOGULS WITH COVER, GASKET & ROLLERS

FOR THREADED RIGID CONDUIT AND IMC

APPLICATION

- Larger body size facilitates pulling of large and heavy conductors. Specially designed raised cast covers provide additional wiring area.
- SEPCO Moguls are used for pulling straight, 45° or 90° angle turns and/or making taps and splices.

FEATURES

- Exclusive built-in rollers facilitate cable pulling from sizes 1 1/4" - 4".
- Smooth, rounded integral bushing in each hub protects conductor insulation.
- Accurately taped, tapered threads for tight, rigid joints and ground continuity.
- Covers have captive stainless steel screws to speed installation, prevent 'freezing' of screws.
- Length Requirement: distance between centerline of each hub bushing (conduit stop) exceeds eight times the trade diameter of the conduit per NEC 314.28(A)(2).

STANDARD MATERIALS

Bodies and Covers: Malleable Iron
Gaskets: Neoprene
Screws: Stainless Steel

STANDARD FINISH

Bodies and Covers: Hot-Dipped Galvanized

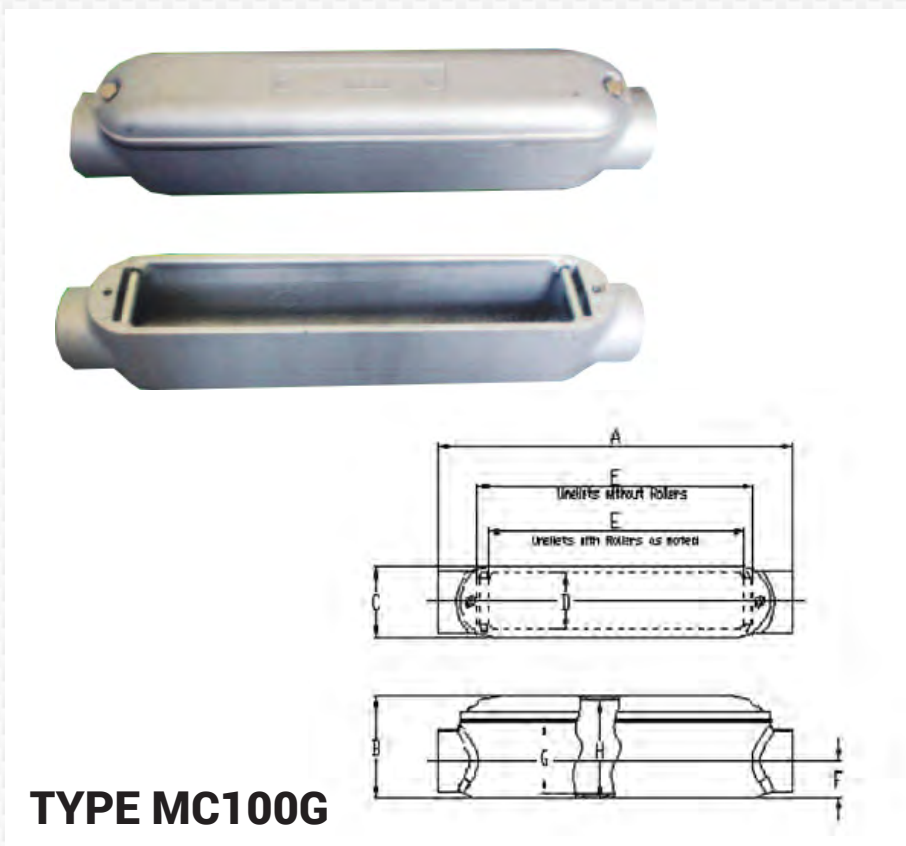

TYPE MC100G

CATALOG NUMBER	TRADE SIZE	MAX WIRE SIZE	VOL. CU.IN.	UNIT PACK	MASTER PACK	LBS. / 100 PCS.	UPC#
MC100G	1"	3 #2 AWG	31.00	—	1	390	10039
MC125G	1-1/4"	3 #1/0 AWG	50.00	—	1	506	10040
MC150G	1-1/2"	3 #3/0 AWG	93.00	—	1	923	10041
MC200G	2"	3 #300 MCM	143.00	—	1	1327	10042
MC250G	2-1/2"	3 #400 MCM	335.00	—	1	2751	10043
MC300G	3"	3 #700 MCM	475.00	—	1	3618	10044
MC350G	3-1/2"	3 #900 MCM	830.00	—	1	5464	10045
MC400G	4"	3 #1000 MCM	1010.00	—	1	6478	10046

CATALOG NUMBER	DIM A	DIM B	DIM C	DIM D	DIM E	DIM F	DIM G	DIM H	NUMBER OF COVER HOLES
MC100G	9.88	2.78	2.36	1.85	6.61	0.93	1.82	2.46	2
MC125G	12.20	3.43	2.44	1.93	7.83	1.14	2.27	3.11	2
MC150G	14.17	3.86	3.15	2.56	9.88	1.34	2.57	3.43	2
MC200G	18.15	4.41	3.15	2.52	13.29	1.63	3.13	3.98	2
MC250G	23.35	5.22	4.65	3.74	13.68	1.81	3.61	4.72	4
MC300G	27.17	6.06	4.72	3.66	21.04	2.20	4.45	5.57	4
MC350G	31.57	7.05	5.72	4.57	24.98	2.50	4.72	6.50	4
MC400G	35.55	7.56	5.72	4.57	29.11	2.76	5.23	7.01	4

MALLEABLE IRON/**HOT DIPPED GALVANIZED** MOGULS WITH COVER, GASKET & ROLLERS

FOR THREADED RIGID CONDUIT AND IMC

APPLICATION

- Larger body size facilitates pulling of large and heavy conductors. Specially designed raised cast covers provide additional wiring area.
- SEPCO Moguls are used for pulling straight, 45° or 90° angle turns and/or making taps and splices.

FEATURES

- Exclusive built-in rollers facilitate cable pulling from sizes 1 1/4" - 4".
- Smooth, rounded integral bushing in each hub protects conductor insulation.
- Accurately taped, tapered threads for tight, rigid joints and ground continuity.
- Covers have captive stainless steel screws to speed installation, prevent 'freezing' of screws.
- Length Requirement: distance between centerline of each hub bushing (conduit stop) exceeds six times the trade diameter of the conduit per NEC 314.28(A)(2).

STANDARD MATERIALS

Bodies and Covers: Malleable Iron
Gaskets: Neoprene
Screws: Stainless Steel

STANDARD FINISH

Bodies and Covers: Hot-Dipped Galvanized

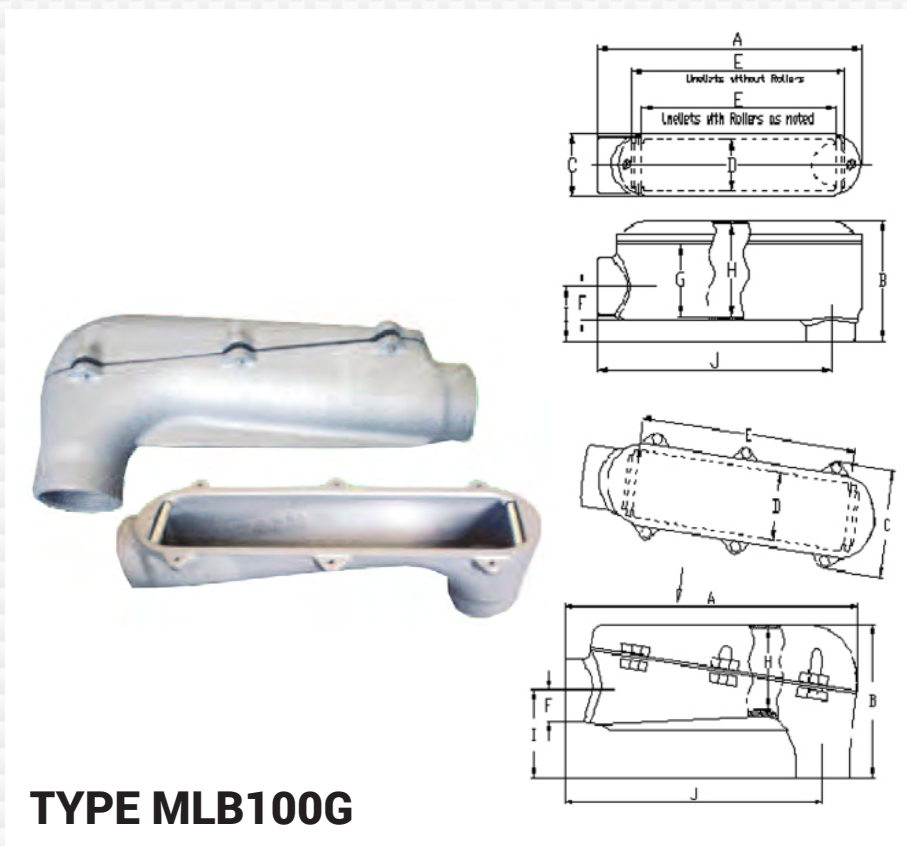

TYPE MLB100G

CATALOG NUMBER	TRADE SIZE	MAX WIRE SIZE	VOL. CU.IN.	UNIT PACK	MASTER PACK	LBS. / 100 PCS.	UPC#
MLB100G	1"	3 #2 AWG	31.00	—	1	366	10047
MLB125G	1-1/4"	3 #1/0 AWG	48.00	—	1	476	10048
MLB150G	1-1/2"	3 #3/0 AWG	107.00	—	1	831	10049
MLB200G	2"	3 #300 MCM	145.00	—	1	1224	10050
MLB250G	2-1/2"	3 #400 MCM	210.00	—	1	2104	10055
MLB300G	3"	3 #700 MCM	345.00	—	1	3237	10052
MLB350G	3-1/2"	3 #900 MCM	500.00	—	1	4427	10053
MLB400G	4"	3 #1000 MCM	740.00	—	1	5865	10054

CATALOG NUMBER	DIM A	DIM B	DIM C	DIM D	DIM E	DIM F	DIM G	DIM H	DIM I	DIM J	NUMBER OF COVER HOLES
MLB100G	8.90	3.75	2.38	1.87	6.57	0.94	1.88	2.52	1.89	7.87	2
MLB125G	9.65	4.86	2.40	1.89	6.47	1.16	2.70	3.52	2.19	8.48	2
MLB150G	12.95	5.25	3.07	2.40	9.49	1.38	3.09	4.07	2.36	11.63	2
MLB200G	14.65	6.38	3.11	2.52	10.91	1.61	3.46	4.96	2.64	12.94	2
MLB250G	18.22	8.23	5.79	3.60	13.48	2.15	—	4.36	4.69	16.03	6
MLB300G	21.33	10.37	5.79	3.47	16.95	2.75	—	5.27	5.61	18.62	6
MLB350G	24.65	10.97	6.93	4.53	19.94	3.01	—	5.15	6.63	21.55	6
MLB400G	27.67	13.03	7.01	4.57	23.38	3.43	—	6.85	7.05	24.32	6

MALLEABLE IRON/**HOT DIPPED GALVANIZED** MOGULS WITH COVER AND GASKET

FOR THREADED RIGID CONDUIT AND IMC

APPLICATION

- Larger body size facilitates pulling of large and heavy conductors. Specially designed raised cast covers provide additional wiring area.
- SEPCO Moguls are used for pulling straight, 45° or 90° angle turns and/or making taps and splices.

FEATURES

- Smooth, rounded integral bushing in each hub protects conductor insulation.
- Accurately taped, tapered threads for tight, rigid joints and ground continuity.
- Covers have captive stainless steel screws to speed installation, prevent 'freezing' of screws.
- Length Requirement: distance between centerline of each hub bushing (conduit stop) exceeds six times the trade diameter of the conduit per NEC 314.28(A)(2).

STANDARD MATERIALS

Bodies and Covers: Malleable Iron
Gaskets: Neoprene
Screws: Stainless Steel

STANDARD FINISH

Bodies and Covers: Hot-Dipped Galvanized

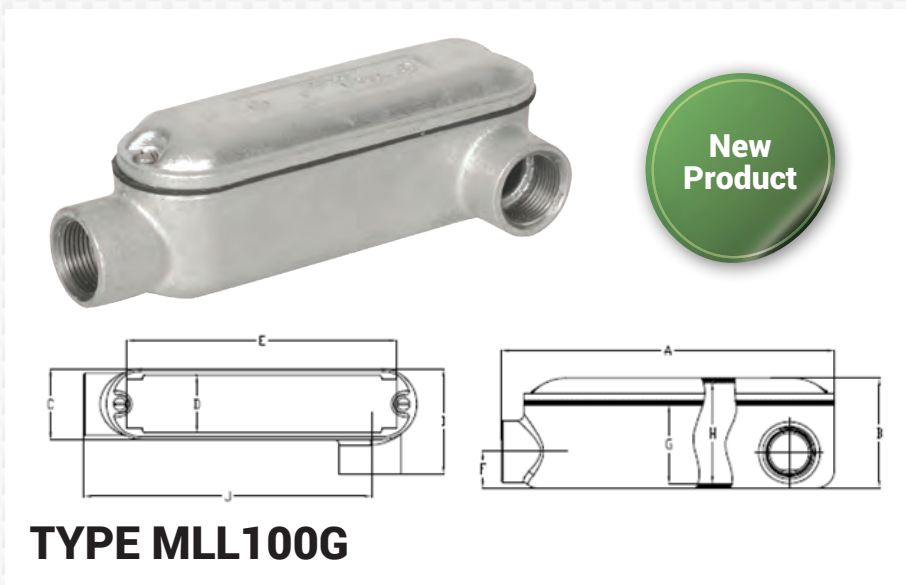

TYPE MLL100G

CATALOG NUMBER	TRADE SIZE	MAX WIRE SIZE	VOL. CU.IN.	UNIT PACK	MASTER PACK	LBS. / 100 PCS.	UPC#
MLL100G	1"	3 #4 AWG	31	-	1	179	10146
MLL125G	1-1/4"	3 #2 AWG	50	-	1	261	10147
MLL150G	1-1/2"	3 #1/0 AWG	93	-	1	459	10148
MLL200G	2"	3 #4/0 AWG	143	-	1	631	10149

CATALOG NUMBER	DIM A	DIM B	DIM C	DIM D	DIM E	DIM F	DIM G	DIM H	DIM I	DIM J	NUMBER OF COVER HOLES
MLL100G	8.94	2.80	2.36	1.85	6.61	0.93	1.84	2.48	3.27	7.76	2
MLL125G	11.16	3.44	2.44	1.93	7.60	1.14	2.28	3.13	3.39	9.94	2
MLL150G	13.27	3.88	3.15	2.56	9.68	1.34	2.57	3.46	4.00	11.69	2
MLL200G	17.02	4.43	3.15	2.52	13.09	1.63	3.14	4.02	4.13	15.45	2

MALLEABLE IRON/**HOT DIPPED GALVANIZED** MOGULS WITH COVER AND GASKET

FOR THREADED RIGID CONDUIT AND IMC

APPLICATION

- Larger body size facilitates pulling of large and heavy conductors. Specially designed raised cast covers provide additional wiring area.
- SEPCO Moguls are used for pulling straight, 45° or 90° angle turns and/or making taps and splices.

FEATURES

- Smooth, rounded integral bushing in each hub protects conductor insulation.
- Accurately tapered, tapered threads for tight, rigid joints and ground continuity.
- Covers have captive stainless steel screws to speed installation, prevent "freezing" of screws.
- Length Requirement: distance between centerline of each hub bushing (conduit stop) exceeds six times the trade diameter of the conduit per NEC 314.28(A)(2).

STANDARD MATERIALS

Bodies and Covers: Malleable Iron
Gaskets: Neoprene
Screws: Stainless Steel

STANDARD FINISH

Bodies and Covers: Hot-Dipped Galvanized

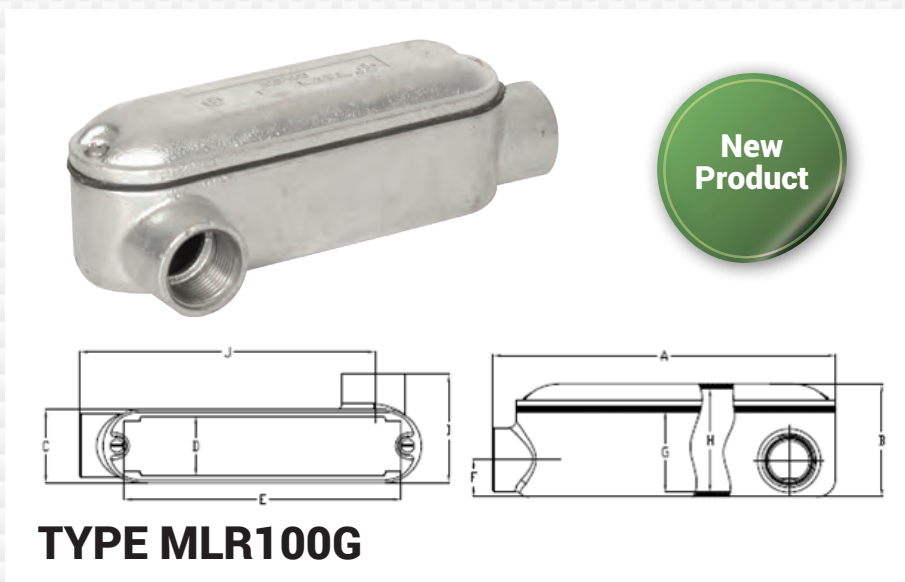

TYPE MLR100G

CATALOG NUMBER	TRADE SIZE	MAX WIRE SIZE	VOL. CU.IN.	UNIT PACK	MASTER PACK	LBS. / 100 PCS.	UPC#
MLR100G	1"	3 #4 AWG	31	-	1	176	10150
MLR125G	1-1/4"	3 #2 AWG	50	-	1	261	10151
MLR150G	1-1/2"	3 #1/0 AWG	93	-	1	435	10152
MLR200G	2"	3 #4/0 AWG	143	-	1	656	10153

CATALOG NUMBER	DIM A	DIM B	DIM C	DIM D	DIM E	DIM F	DIM G	DIM H	DIM I	DIM J	NUMBER OF COVER HOLES
MLR100G	8.94	2.80	2.36	1.85	6.61	0.93	1.84	2.48	3.27	7.76	2
MLR125G	11.16	3.44	2.44	1.93	7.60	1.14	2.28	3.13	3.39	9.94	2
MLR150G	13.27	3.88	3.15	2.56	9.68	1.34	2.57	3.46	4.00	11.69	2
MLR200G	17.02	4.43	3.15	2.52	13.09	1.63	3.14	4.02	4.13	15.45	2

MALLEABLE IRON/**HOT DIPPED GALVANIZED** MOGULS WITH COVER AND GASKET

FOR THREADED RIGID CONDUIT AND IMC

APPLICATION

- Larger body size facilitates pulling of large and heavy conductors. Specially designed raised cast covers provide additional wiring area.
- SEPCO Moguls are used for pulling straight, 45° or 90° angle turns and/or making taps and splices.

FEATURES

- Smooth, rounded integral bushing in each hub protects conductor insulation.
- Accurately taped, tapered threads for tight, rigid joints and ground continuity.
- Covers have captive stainless steel screws to speed installation, prevent 'freezing' of screws.
- Length Requirement: distance between centerline of each hub bushing (conduit stop) exceeds six times the trade diameter of the conduit per NEC 314.28(A)(2).

STANDARD MATERIALS

Bodies and Covers: Malleable Iron
Gaskets: Neoprene
Screws: Stainless Steel

STANDARD FINISH

Bodies and Covers: Hot-Dipped Galvanized

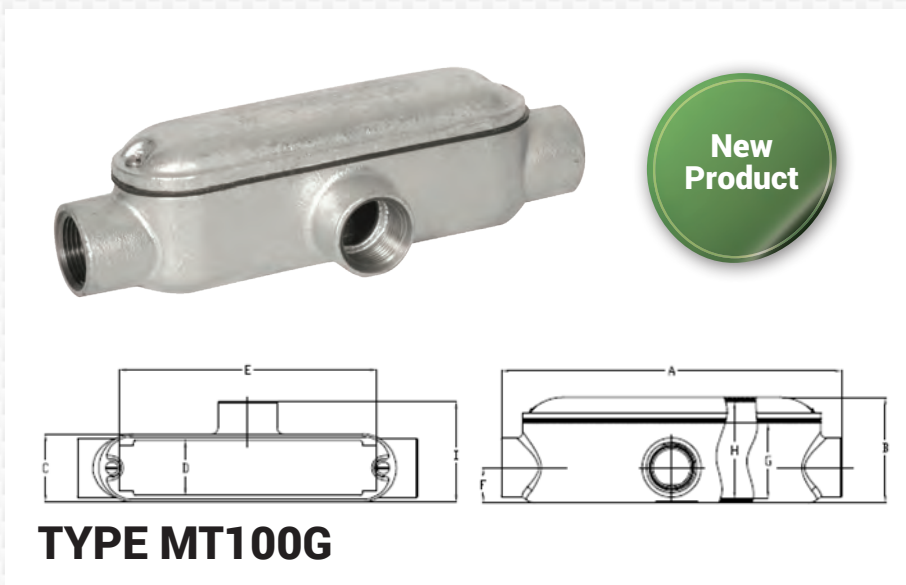

TYPE MT100G

CATALOG NUMBER	TRADE SIZE	MAX WIRE SIZE	VOL. CU.IN.	UNIT PACK	MASTER PACK	LBS. / 100 PCS.	UPC#
MT100G	1"	3 #4 AWG	31	-	1	187	10154
MT125G	1-1/4"	3 #2 AWG	50	-	1	263	10155
MT150G	1-1/2"	3 #1/0 AWG	93	-	1	447	10156
MT200G	2"	3 #4/0 AWG	143	-	1	651	10157

CATALOG NUMBER	DIM A	DIM B	DIM C	DIM D	DIM E	DIM F	DIM G	DIM H	DIM I	NUMBER OF COVER HOLES
MT100G	9.88	2.80	2.36	1.85	6.61	0.93	1.84	2.48	3.27	2
MT125G	12.64	3.44	2.44	1.93	7.60	1.14	2.28	3.13	3.39	2
MT150G	14.17	3.88	3.15	2.56	9.68	1.34	2.57	3.46	4.00	2
MT200G	18.15	4.43	3.15	2.52	13.09	1.63	3.14	4.02	4.02	2

MALLEABLE IRON THREADED CONDUIT BODIES

FOR THREADED RIGID CONDUIT AND IMC

APPLICATION

To provide access to conductors for pulling, splicing, and maintenance. Threaded for rigid conduit and IMC.

FEATURES

- Tapered threaded hubs (NPT)
- Flat back design for easy mounting close to walls
- Suitable for use in concrete

STANDARD MATERIALS

Malleable Iron

STANDARD FINISH

Zinc Plated



TYPE C1

CATALOG NUMBER	TRADE SIZE	DIM A	DIM B	DIM C	MAX WIRE SIZE	VOL. CU.IN.	UNIT PACK	MASTER PACK	LBS. / 100 PCS.	UPC #
C TYPE										
C1	1/2"	5.375	1.313	1.375	N/A	4.50	10	50	98	43010
C2	3/4"	6.000	1.500	1.688	3 #6 AWG	7.50	10	50	118	43020
C3	1"	7.063	1.813	1.875	3 #4 AWG	12.50	5	25	170	43030
C4	1-1/4"	9.000	2.625	2.750	3 #2 AWG	32.30	—	10	309	43040
C5	1-1/2"	9.000	2.625	2.813	3 #1/0 AWG	35.30	—	10	368	43050
C6	2"	11.500	3.125	3.313	3 #4/0 AWG	73.00	—	5	553	43060
C7	2-1/2"	15.000	4.313	3.875	3 #250 MCM	138.00	—	1	1216	43070
C8	3"	15.125	4.313	4.750	3 #250 MCM	170.00	—	1	1437	43080
C9	3-1/2"	18.125	4.875	5.625	3 #350 MCM	300.00	—	1	2210	43090
C10	4"	18.125	4.875	5.625	3 #350 MCM	328.00	—	1	2321	43100

OPTIONAL FINISH

For additional corrosion protection, specify Hot Dipped Galvanized. Add suffix 'G' to Malleable Iron catalog number. Example LB1G. For more information, see page 11.

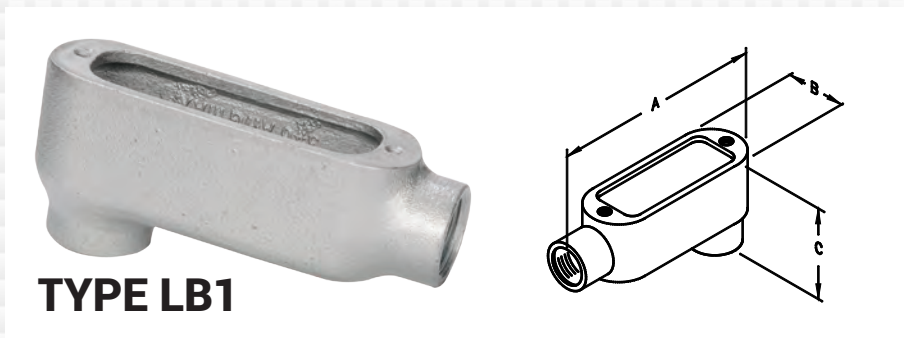

TYPE LB1

CATALOG NUMBER	TRADE SIZE	DIM A	DIM B	DIM C	MAX WIRE SIZE	VOL. CU.IN.	UNIT PACK	MASTER PACK	LBS. / 100 PCS.	UPC #
LB TYPE										
LB1	1/2"	4.688	1.313	2.063	N/A	4.50	10	50	71	40011
LB2	3/4"	5.375	1.500	2.250	3 #6 AWG	7.50	10	50	97	40021
LB3	1"	6.188	1.813	2.625	3 #4 AWG	12.50	5	25	143	40031
LB4	1-1/4"	8.125	2.625	2.750	3 #2 AWG	32.30	—	10	287	40041
LB5	1-1/2"	8.125	2.625	2.813	3 #1/0 AWG	35.30	—	10	332	40051
LB6	2"	10.500	3.125	4.438	3 #4/0 AWG	73.00	—	5	534	40061
LB7	2-1/2"	13.625	4.313	5.375	3 #350 AWG	138.00	—	1	1105	40071
LB8	3"	13.875	4.313	5.875	3 #350 AWG	170.00	—	1	1160	40081
LB9	3-1/2"	16.250	5.625	6.875	3 #500 MCM	300.00	—	1	1989	40091
LB10	4"	16.625	5.625	7.188	3 #500 MCM	328.00	—	1	2100	40101

MALLEABLE IRON THREADED CONDUIT BODIES

FOR THREADED RIGID CONDUIT AND IMC

APPLICATION

To provide access to conductors for pulling, splicing, and maintenance. Threaded for rigid conduit and IMC.

FEATURES

- Tapered threaded hubs (NPT)
- Flat back design for easy mounting close to walls
- Suitable for use in concrete

STANDARD MATERIALS

Malleable Iron

STANDARD FINISH

Zinc Plated



TYPE LL1

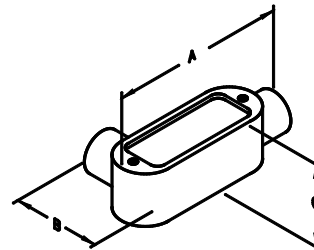

CATALOG NUMBER	TRADE SIZE	DIM A	DIM B	DIM C	MAX WIRE SIZE	VOL. CU.IN.	UNIT PACK	MASTER PACK	LBS. / 100 PCS.	UPC #
LL TYPE										
LL1	1/2"	4.688	2.063	1.375	N/A	4.50	10	50	76	41011
LL2	3/4"	5.375	2.250	1.688	3 #6 AWG	7.50	10	50	95	41021
LL3	1"	6.188	2.625	1.875	3 #4 AWG	12.50	5	25	138	41031
LL4	1-1/4"	8.125	2.750	2.750	3 #2 AWG	32.30	—	10	309	41041
LL5	1-1/2"	8.125	3.500	2.813	3 #1/0 AWAG	35.30	—	10	332	41051
LL6	2"	10.500	4.125	3.313	3 #4/0 AWG	73.00	—	5	497	41061
LL7	2-1/2"	13.625	4.688	3.875	3 #300 MCM	138.00	—	1	1105	41071
LL8	3"	13.875	5.875	4.750	3 #350 MCM	170.00	—	1	1437	41081
LL9	3-1/2"	16.250	6.125	5.625	3 #350 MCM	300.00	—	1	2321	41091
LL10	4"	16.250	6.938	5.625	3 #350 MCM	328.00	—	1	2431	41101

OPTIONAL FINISH

For additional corrosion protection, specify Hot Dipped Galvanized. Add suffix 'G' to Malleable Iron catalog number. Example LL1G. For more information, see page 12.



TYPE LR1

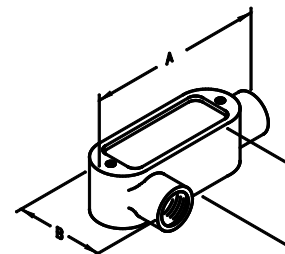

CATALOG NUMBER	TRADE SIZE	DIM A	DIM B	DIM C	MAX WIRE SIZE	VOL. CU.IN.	UNIT PACK	MASTER PACK	LBS. / 100 PCS.	UPC #
LR TYPE										
LR1	1/2"	4.688	2.063	1.375	N/A	4.50	10	50	71	42011
LR2	3/4"	5.375	2.250	1.688	3 #6 AWG	7.50	10	50	100	42021
LR3	1"	6.188	2.625	1.875	3 #4 AWG	12.50	5	25	157	42031
LR4	1-1/4"	8.125	2.750	2.750	3 #2 AWG	32.30	—	10	332	42041
LR5	1-1/2"	8.125	2.813	2.813	3 #1/0 AWAG	35.30	—	10	345	42051
LR6	2"	10.500	4.438	3.313	3 #4/0 AWG	73.00	—	5	626	42061
LR7	2-1/2"	13.625	5.375	3.875	3 #300 MCM	138.00	—	1	1105	42071
LR8	3"	13.875	5.875	4.750	3 #350 MCM	170.00	—	1	1437	42081
LR9	3-1/2"	16.250	6.875	5.625	3 #350 MCM	300.00	—	1	2321	42091
LR10	4"	16.625	7.188	5.625	3 #350 MCM	328.00	—	1	2500	42101

MALLEABLE IRON THREADED CONDUIT BODIES

FOR THREADED RIGID CONDUIT AND IMC

APPLICATION

To provide access to conductors for pulling, splicing, and maintenance. Threaded for rigid conduit and IMC.

FEATURES

- Tapered threaded hubs (NPT)
- Flat back design for easy mounting close to walls
- Suitable for use in concrete

STANDARD MATERIALS

Malleable Iron

STANDARD FINISH

Zinc Plated

OPTIONAL FINISH

For additional corrosion protection, specify Hot Dipped Galvanized. Add suffix 'G' to Malleable Iron catalog number. Example T1G. For more information, see page 13.



TYPE T1

CATALOG NUMBER	TRADE SIZE	DIM A	DIM B	DIM C	MAX WIRE SIZE	VOL. CU.IN.	UNIT PACK	MASTER PACK	LBS. / 100 PCS.	UPC #
T TYPE										
T1	1/2"	5.375	2.063	1.313	N/A	6.00	10	50	111	44011
T2	3/4"	6.000	2.250	1.500	3 #6 AWG	9.50	10	50	137	44021
T3	1"	7.063	2.625	1.813	3 #4 AWG	15.00	5	25	195	44031
T4	1-1/4"	9.000	2.750	2.625	3 #2 AWG	33.00	—	10	332	44041
T5	1-1/2"	9.000	3.500	2.625	3 #2 AWG	36.00	—	10	368	44051
T6	2"	11.500	4.125	3.125	3 #1/0 AWG	75.00	—	5	663	44061
T7	2-1/2"	15.000	5.688	4.313	3 #4/0 AWG	138.00	—	1	1271	44071
T8	3"	15.125	5.875	4.313	3 #4/0 AWG	170.00	—	1	1547	44081
T9	3-1/2"	18.125	6.813	4.875	3 #350 MCM	300.00	—	1	2542	44091
T10	4"	18.125	7.188	4.875	3 #350 MCM	328.00	—	1	2542	44101



TYPE TB1

CATALOG NUMBER	TRADE SIZE	DIM A	DIM B	DIM C	MAX WIRE SIZE	VOL. CU.IN.	UNIT PACK	MASTER PACK	LBS. / 100 PCS.	UPC #
TB Type										
TB1	1/2"	5.250	1.313	1.313	N/A	6	10	50	88	64011
TB2	3/4"	6.063	1.563	1.563	3 #6 AWG	9.5	10	50	120	64012
TB3	1"	7.125	1.813	1.813	3 #4 AWG	15	5	25	197	64013
TB4	1-1/4"	9.313	2.438	3.750	3 #2 AWG	33	-	10	343	64014
TB5	1-1/2"	9.313	2.563	3.750	3 #2 AWG	36	-	10	420	64015
TB6	2"	11.813	3.188	4.125	3 #1/0 AWG	75	-	5	691	64016

MALLEABLE IRON/**HOT DIPPED GALVANIZED** THREADED CONDUIT BODIES

FOR THREADED RIGID CONDUIT AND IMC

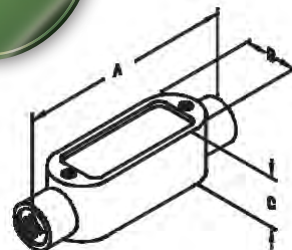

TYPE C1G

APPLICATION

To provide access to conductors for pulling, splicing, and maintenance. Threaded for rigid conduit and IMC.

FEATURES

- Exclusive built-in rollers facilitate cable pulling from sizes 1 1/4" - 4"
- Tapered threaded hubs (NPT)
- Flat back design for easy mounting close to walls
- Suitable for use in concrete

STANDARD MATERIALS

Malleable Iron

STANDARD FINISH

Hot Dipped Galvanized/Zinc Plated



CATALOG NUMBER	TRADE SIZE	DIM A	DIM B	DIM C	MAX WIRE SIZE	VOL. CU.IN.	UNIT PACK	MASTER PACK	LBS. / 100 PCS.	UPC #
C Type										
C1G	1/2"	5.375	1.313	1.375	N/A	4.50	10	50	98	10158
C2G	3/4"	6.000	1.500	1.688	3 #6 AWG	7.50	10	50	118	10159
C3G	1"	7.063	1.813	1.875	3 #4 AWG	12.50	5	25	170	10160
C4G	1-1/4"	9.000	2.625	2.750	3 #2 AWG	32.30	—	10	309	10161
C5G	1-1/2"	9.000	2.625	2.813	3 #1/0 AWG	35.30	—	10	368	10162
C6G	2"	11.500	3.125	3.313	3 #4/0 AWG	73.00	—	5	553	10163
C7G	2-1/2"	15.000	4.313	3.875	3 #250 MCM	138.00	—	1	1216	10188
C8G	3"	15.125	4.313	4.750	3 #250 MCM	170.00	—	1	1437	10189
C9G	3-1/2"	18.125	4.875	5.625	3 #350 MCM	300.00	—	1	2210	10190
C10G	4"	18.125	4.875	5.625	3 #350 MCM	328.00	—	1	2321	10191

OPTIONAL FINISH

For Malleable Iron / Zinc Plated, please remove suffix 'G' from Hot Dipped Galvanized Catalog Number and see page 35.

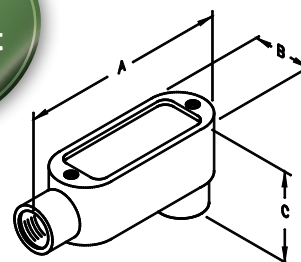

TYPE LB1G

CATALOG NUMBER	TRADE SIZE	DIM A	DIM B	DIM C	MAX WIRE SIZE	VOL. CU.IN.	UNIT PACK	MASTER PACK	LBS. / 100 PCS.	UPC #
LB Type										
LB1G	1/2"	4.688	1.313	2.063	N/A	4.50	10	50	71	10164
LB2G	3/4"	5.375	1.500	2.250	3 #6 AWG	7.50	10	50	97	10165
LB3G	1"	6.188	1.813	2.625	3 #4 AWG	12.50	5	25	143	10166
LB4G	1-1/4"	8.125	2.625	2.750	3 #2 AWG	32.30	—	10	287	10167
LB5G	1-1/2"	8.125	2.625	2.813	3 #1/0 AWG	35.30	—	10	332	10168
LB6G	2"	10.500	3.125	4.438	3 #4/0 AWG	73.00	—	5	534	10169
LB7G	2-1/2"	13.625	4.313	5.375	3 #350 AWG	138.00	—	1	1105	10192
LB8G	3"	13.875	4.313	5.875	3 #350 AWG	170.00	—	1	1160	10193
LB9G	3-1/2"	16.250	5.625	6.875	3 #500 MCM	300.00	—	1	1989	10194
LB10G	4"	16.625	5.625	7.188	3 #500 MCM	328.00	—	1	2100	10195

MALLEABLE IRON/**HOT DIPPED GALVANIZED** THREADED CONDUIT BODIES

FOR THREADED RIGID CONDUIT AND IMC

APPLICATION

To provide access to conductors for pulling, splicing, and maintenance. Threaded for rigid conduit and IMC.

FEATURES

- Exclusive built-in rollers facilitate cable pulling from sizes 1 1/4" - 4"
- Tapered threaded hubs (NPT)
- Flat back design for easy mounting close to walls
- Suitable for use in concrete

STANDARD MATERIALS

Malleable Iron

STANDARD FINISH

Hot Dipped Galvanized/Zinc Plated



TYPE LL1G

CATALOG NUMBER	TRADE SIZE	DIM A	DIM B	DIM C	MAX WIRE SIZE	VOL. CU.IN.	UNIT PACK	MASTER PACK	LBS. / 100 PCS.	UPC #
LL Type										
LL1G	1/2"	4.688	2.063	1.375	N/A	4.50	10	50	76	10170
LL2G	3/4"	5.375	2.250	1.688	3 #6 AWG	7.50	10	50	95	10171
LL3G	1"	6.188	2.625	1.875	3 #4 AWG	12.50	5	25	138	10172
LL4G	1-1/4"	8.125	2.750	2.750	3 #2 AWG	32.30	—	10	309	10173
LL5G	1-1/2"	8.125	3.500	2.813	3 #1/0 AWG	35.30	—	10	332	10174
LL6G	2"	10.500	4.125	3.313	3 #4/0 AWG	73.00	—	5	497	10175
LL7G	2-1/2"	13.625	4.688	3.875	3 #300 MCM	138.00	—	1	1105	10196
LL8G	3"	13.875	5.875	4.750	3 #350 MCM	170.00	—	1	1437	10197
LL9G	3-1/2"	16.250	6.125	5.625	3 #350 MCM	300.00	—	1	2321	10198
LL10G	4"	16.250	6.938	5.625	3 #350 MCM	328.00	—	1	2431	10199

OPTIONAL FINISH

For Malleable Iron / Zinc Plated, please remove suffix 'G' from Hot Dipped Galvanized Catalog Number and see page 36.



TYPE LR1G

CATALOG NUMBER	TRADE SIZE	DIM A	DIM B	DIM C	MAX WIRE SIZE	VOL. CU.IN.	UNIT PACK	MASTER PACK	LBS. / 100 PCS.	UPC #
LR Type										
LR1G	1/2"	4.688	2.063	1.375	N/A	4.50	10	50	71	10176
LR2G	3/4"	5.375	2.250	1.688	3 #6 AWG	7.50	10	50	100	10177
LR3G	1"	6.188	2.625	1.875	3 #4 AWG	12.50	5	25	157	10178
LR4G	1-1/4"	8.125	2.750	2.750	3 #2 AWG	32.30	—	10	332	10179
LR5G	1-1/2"	8.125	2.813	2.813	3 #1/0 AWG	35.30	—	10	345	10180
LR6G	2"	10.500	4.438	3.313	3 #4/0 AWG	73.00	—	5	626	10181
LR7G	2-1/2"	13.625	5.375	3.875	3 #300 MCM	138.00	—	1	1105	10200
LR8G	3"	13.875	5.875	4.750	3 #350 MCM	170.00	—	1	1437	10201
LR9G	3-1/2"	16.250	6.875	5.625	3 #350 MCM	300.00	—	1	2321	10202
LR10G	4"	16.625	7.188	5.625	3 #350 MCM	328.00	—	1	2500	10203

MALLEABLE IRON/**HOT DIPPED GALVANIZED** THREADED CONDUIT BODIES

FOR THREADED RIGID CONDUIT AND IMC

APPLICATION

To provide access to conductors for pulling, splicing, and maintenance. Threaded for rigid conduit and IMC.

FEATURES

- Exclusive built-in rollers facilitate cable pulling from sizes 1 1/4" - 4"
- Tapered threaded hubs (NPT)
- Flat back design for easy mounting close to walls
- Suitable for use in concrete

STANDARD MATERIALS

Malleable Iron

STANDARD FINISH

Hot Dipped Galvanized/Zinc Plated

OPTIONAL FINISH

For Malleable Iron / Zinc Plated, please remove suffix 'G' from Hot Dipped Galvanized Catalog Number and see page 37.



TYPE T1G

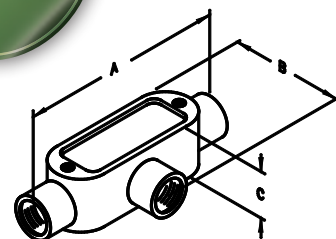

CATALOG NUMBER	TRADE SIZE	DIM A	DIM B	DIM C	MAX WIRE SIZE	VOL. CU.IN.	UNIT PACK	MASTER PACK	LBS. / 100 PCS.	UPC #
T Type										
T1G	1/2"	5.375	2.063	1.313	N/A	6.00	10	50	111	10182
T2G	3/4"	6.000	2.250	1.500	3 #6 AWG	9.50	10	50	137	10183
T3G	1"	7.063	2.625	1.813	3 #4 AWG	15.00	5	25	195	10184
T4G	1-1/4"	9.000	2.750	2.625	3 #2 AWG	33.00	—	10	332	10185
T5G	1-1/2"	9.000	3.500	2.625	3 #1/0 AWG	36.00	—	10	368	10186
T6G	2"	11.500	4.125	3.125	3 #1/0 AWG	75.00	—	5	663	10187
T7G	2-1/2"	15.000	5.688	4.313	3 #4/0 AWG	138.00	—	1	1271	10204
T8G	3"	15.125	5.875	4.313	3 #4/0 AWG	170.00	—	1	1547	10205
T9G	3-1/2"	18.125	6.813	4.875	3 #350 MCM	300.00	—	1	2542	10206
T10G	4"	18.125	7.188	4.875	3 #350 MCM	328.00	—	1	2542	10207

FORM 7 CONDUIT BODIES

FOR THREADED RIGID CONDUIT AND IMC

APPLICATION

To provide access to conductors for pulling, splicing, maintenance and future changes / upgrades. Allows connection of straight conduit runs, branch conduit runs and 90° bends

FEATURES

- Time saving Clip-On covers in steel or gray iron
- Tapered threads hubs (NPT)
- Flat back designs for greater wiring capacity and surface mounting
- Complete interchangeability with other manufacturers Form 7 conduit bodies
- Internal volume and maximum wire clearly marked on castings

STANDARD MATERIALS

Gray Iron

STANDARD FINISH

Zinc Plated

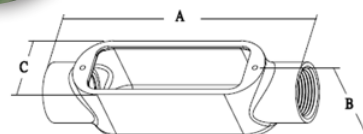

TYPE C27F7

CATALOG NUMBER	TRADE SIZE	DIM A	DIM B	DIM C	MAX WIRE SIZE	VOL. CU.IN.	UNIT PACK	MASTER PACK	LBS. / 100 PCS.	UPC #
C Type										
C17F7	1/2"	5.31	1.40	1.35	N/A	3.80	10	50	84	10480
C27F7	3/4"	6.16	1.65	1.65	3 #6 AWG	5.80	5	50	131	10481
C37F7	1"	7.30	1.79	1.79	3 #4 AWG	9.00	5	25	191	10482
C47F7	1-1/4"	7.43	2.20	2.20	3 #2 AWG	17.80	1	10	276	10483
C57F7	1-1/2"	8.16	2.45	2.45	3 #2 AWG	24.00	1	10	336	10484
C67F7	2"	9.13	3.01	3.01	3 #1/0 AWG	45.00	1	5	519	10485
C77F7	2-1/2"	12.36	4.25	4.25	3 #2/0 MCM	95.80	-	1	1068	10486
C87F7	3"	12.36	4.25	4.25	3 #2/0 MCM	119.00	-	1	1311	10487
C97F7	3-1/2"	14.49	5.31	5.31	3 #250 MCM	208.00	-	1	1764	10488
C107F7	4"	14.49	5.31	5.31	3 #250 MCM	231.00	-	1	1882	10489

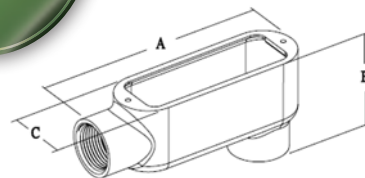

TYPE LB27F7

CATALOG NUMBER	TRADE SIZE	DIM A	DIM B	DIM C	MAX WIRE SIZE	VOL. CU.IN.	UNIT PACK	MASTER PACK	LBS. / 100 PCS.	UPC #
LB Type										
LB17F7	1/2"	4.49	2.22	1.35	N/A	3.80	10	50	86	10450
LB27F7	3/4"	5.22	2.49	1.65	3 #6 AWG	5.80	5	50	134	10451
LB37F7	1"	6.17	2.85	1.79	3 #4 AWG	9.00	5	25	188	10452
LB47F7	1-1/4"	6.50	3.24	2.20	3 #2 AWG	17.80	1	10	279	10453
LB57F7	1-1/2"	7.09	3.54	2.45	3 #2 AWG	24.50	1	10	350	10454
LB67F7	2"	8.11	4.13	3.01	3 #1/0 AWG	45.00	1	5	542	10455
LB77F7	2-1/2"	10.71	5.26	4.25	3 #2/0 MCM	95.80	-	1	1101	10456
LB87F7	3"	10.71	6.02	4.25	3 #2/0 MCM	119.00	-	1	1323	10457
LB97F7	3-1/2"	12.76	6.59	5.31	3 #250 MCM	208.00	-	1	1808	10458
LB107F7	4"	12.76	7.10	5.31	3 #250 MCM	231.00	-	1	1933	10459

FORM 7 CONDUIT BODIES

FOR THREADED RIGID CONDUIT AND IMC

APPLICATION

To provide access to conductors for pulling, splicing, maintenance and future changes / upgrades. Allows connection of straight conduit runs, branch conduit runs and 90° bends

FEATURES

- Time saving Clip-On covers in steel or gray iron
- Tapered threads hubs (NPT)
- Flat back designs for greater wiring capacity and surface mounting
- Complete interchangeability with other manufacturers Form 7 conduit bodies
- Internal volume and maximum wire clearly marked on castings

STANDARD MATERIALS

Gray Iron

STANDARD FINISH

Zinc Plated



TYPE LL27F7

CATALOG NUMBER	TRADE SIZE	DIM A	DIM B	DIM C	MAX WIRE SIZE	VOL. CU.IN.	UNIT PACK	MASTER PACK	LBS. / 100 PCS.	UPC #
LL Type										
LL17F7	1/2"	4.49	1.40	1.45	N/A	3.80	10	50	85	10460
LL27F7	3/4"	5.22	1.65	2.49	3 #6 AWG	5.80	5	50	130	10461
LL37F7	1"	6.17	1.79	2.76	3 # 4 AWG	9.00	5	25	190	10462
LL47F7	1-1/4"	6.50	2.20	3.13	3 # 2 AWG	17.80	1	10	260	10463
LL57F7	1-1/2"	7.09	2.45	3.39	3 #2 AWG	24.50	1	10	326	10464
LL67F7	2"	8.11	3.01	4.02	3 # 1/0 AWG	45.00	1	5	513	10465
LL77F7	2-1/2"	10.71	4.25	5.85	3 #250 MCM	95.80	-	1	970	10466
LL87F7	3"	10.71	4.25	5.85	3 #250 MCM	119.00	-	1	1146	10467
LL97F7	3-1/2"	12.76	5.31	6.98	3 #350 MCM	208.00	-	1	1631	10468
LL107F7	4"	12.76	5.31	6.98	3 #350 MCM	231.00	-	1	1848	10469



TYPE LR27F7

CATALOG NUMBER	TRADE SIZE	DIM A	DIM B	DIM C	MAX WIRE SIZE	VOL. CU.IN.	UNIT PACK	MASTER PACK	LBS. / 100 PCS.	UPC #
LR Type										
LR17F7	1/2"	4.49	1.40	1.45	N/A	3.80	10	50	85	10470
LR27F7	3/4"	5.22	1.65	2.49	3 #6 AWG	5.80	5	50	130	10471
LR37F7	1"	6.17	1.79	2.76	3 # 4 AWG	9.00	5	25	185	10472
LR47F7	1-1/4"	6.50	2.20	3.13	3 # 2 AWG	17.80	1	10	260	10473
LR57F7	1-1/2"	7.09	2.45	3.39	3 #2 AWG	24.00	1	10	335	10474
LR67F7	2"	8.11	3.01	4.02	3 # 1/0 AWG	45.00	1	5	516	10475
LR77F7	2-1/2"	10.71	4.25	5.85	3 #250 MCM	95.80	-	1	970	10476
LR87F7	3"	10.71	4.25	5.85	3 #250 MCM	119.00	-	1	1146	10477
LR97F7	3-1/2"	12.76	5.31	6.98	3 #350 MCM	208.00	-	1	1764	10478
LR107F7	4"	12.76	5.31	6.98	3 #350 MCM	231.00	-	1	1848	10479

FORM 7 CONDUIT BODIES

FOR THREADED RIGID CONDUIT AND IMC

APPLICATION

To provide access to conductors for pulling, splicing, maintenance and future changes / upgrades. Allows connection of straight conduit runs, branch conduit runs and 90° bends

FEATURES

- Time saving Clip-On covers in steel or gray iron
- Tapered threads hubs (NPT)
- Flat back designs for greater wiring capacity and surface mounting
- Complete interchangeability with other manufacturers Form 7 conduit bodies
- Internal volume and maximum wire clearly marked on castings

STANDARD MATERIALS

Gray Iron

STANDARD FINISH

Zinc Plated



New Product

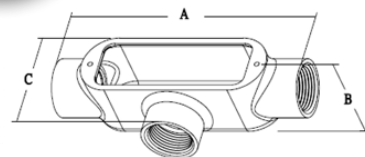
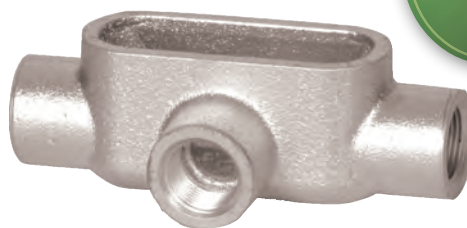

TYPE T27F7

CATALOG NUMBER	TRADE SIZE	DIM A	DIM B	DIM C	MAX WIRE SIZE	VOL. CU.IN.	UNIT PACK	MASTER PACK	LBS. / 100 PCS.	UPC #
T Type										
T17F7	1/2"	5.31	1.77	2.48	N/A	3.80	5	50	109	10490
T27F7	3/4"	6.16	2.01	2.72	3 #6 AWG	5.80	5	50	177	10491
T37F7	1"	7.30	2.28	3.00	3 # 4 AWG	9.00	5	25	242	10492
T47F7	1-1/4"	7.43	2.31	3.13	3 # 2 AWG	17.80	1	10	309	10493
T57F7	1-1/2"	8.16	2.60	3.39	3 #2 AWG	24.00	1	10	384	10494
T67F7	2"	9.13	3.13	4.02	3 # 1/0 AWG	45.00	1	5	586	10495
T77F7	2-1/2"	12.36	3.66	5.85	3 #2/0 MCM	95.80	-	1	1058	10496
T87F7	3"	12.36	4.45	5.85	3 #3/0 MCM	119.00	-	1	1477	10497
T97F7	3-1/2"	14.49	4.92	6.98	3 #250 MCM	208.00	-	1	1940	10498
T107F7	4"	14.49	4.92	6.98	3 #250 MCM	231.00	-	1	2116	10499

ALUMINUM THREADED CONDUIT BODIES

FOR THREADED RIGID CONDUIT AND IMC

APPLICATION

To provide access to conductors for pulling, splicing, and maintenance. Threaded for rigid conduit and IMC

FEATURES

- Tapered threaded hubs (NPT)
- Raintight when used with gasketed covers
- Die cast from high-strength, corrosion and weather resistant, copper-free aluminum alloy.
- Flat back design for easy mounting close to walls

STANDARD MATERIALS

1/2" - 2"
Die cast/Copper-free Aluminum
2-1/2" - 4"
Sand-cast/Copper-free Aluminum

STANDARD FINISH

Aluminum Enameled



TYPE C1A

CATALOG NUMBER	TRADE SIZE	DIM A	DIM B	DIM C	MAX WIRE SIZE	VOL. CU.IN.	UNIT PACK	MASTER PACK	LBS. / 100 PCS.	UPC #
C Type										
C1A	1/2"	4.69	1.38	1.31	N/A	4.35	10	50	21	43015
C2A	3/4"	5.50	1.56	1.63	3 #6 AWG	7.30	10	50	33	43025
C3A	1"	6.48	1.88	1.88	3 #4 AWG	12.20	5	25	46	43035
C4A	1-1/4"	8.31	2.50	2.50	3 #2 AWG	33.50	-	10	82	43045
C5A	1-1/2"	8.38	2.50	2.50	3 #1/0 AWG	33.50	-	10	85	43055
C6A	2"	10.31	3.38	3.38	3 #4/0 AWG	69.50	-	5	188	43065
C7A	2-1/2"	13.12	4.50	4.00	3 #250 MCM	69.50	-	1	325	43075
C8A	3"	13.19	4.56	4.56	3 #250 MCM	188.00	-	1	399	43085
C9A	3-1/2"	16.12	5.69	5.63	3 #300 MCM	307.00	-	1	975	43095
C10A	4"	16.12	5.69	5.63	3 #300 MCM	309.00	-	1	875	43105

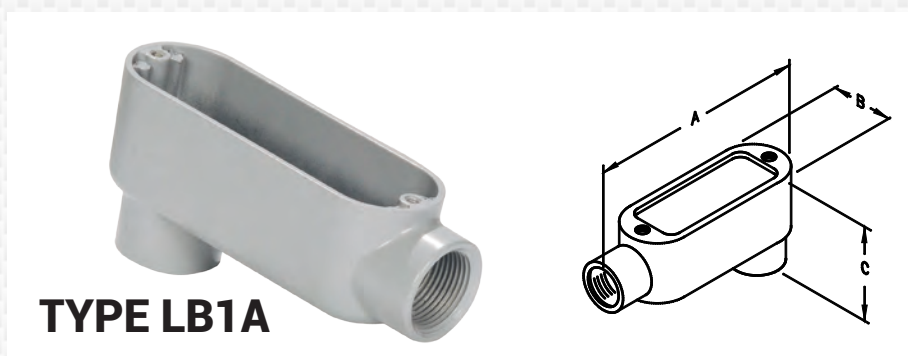

TYPE LB1A

CATALOG NUMBER	TRADE SIZE	DIM A	DIM B	DIM C	MAX WIRE SIZE	VOL. CU.IN.	UNIT PACK	MASTER PACK	LBS. / 100 PCS.	UPC #
LB Type										
LB1A	1/2"	4.31	1.31	2.19	N/A	4.35	10	50	24	40015
LB2A	3/4"	5.06	1.56	2.44	3 #6 AWG	7.25	10	50	37	40025
LB3A	1"	5.87	1.75	2.75	3 #4 AWG	12.20	5	25	46	40035
LB4A	1-1/4"	7.81	2.50	3.44	3 #2 AWG	32.30	-	10	98	40045
LB5A	1-1/2"	7.81	2.50	3.44	3 #2 AWG	33.80	-	10	91	40055
LB6A	2"	10.06	3.12	4.31	3 #4/0 AWG	71.20	-	5	222	40065
LB7A	2-1/2"	12.81	4.50	5.31	3 #4/0 AWG	71.20	-	1	366	40075
LB8A	3"	12.81	4.50	5.94	3 #4/0 AWG	183.50	-	1	430	40085
LB9A	3-1/2"	15.62	5.56	7.06	3 #400 MCM	304.90	-	1	937	40095
LB10A	4"	15.62	5.56	7.06	3 #400 MCM	308.00	-	1	851	40106

ALUMINUM THREADED CONDUIT BODIES

FOR THREADED RIGID CONDUIT AND IMC

APPLICATION

To provide access to conductors for pulling, splicing, and maintenance. Threaded for rigid conduit and IMC

FEATURES

- Tapered threaded hubs (NPT)
- Raintight when used with gasketed covers
- Die cast from high-strength, corrosion and weather resistant, copper-free aluminum alloy.
- Flat back design for easy mounting close to walls

STANDARD MATERIALS

1/2" - 2"
Die cast/Copper-free Aluminum
2-1/2" - 4"
Sand-cast/Copper-free Aluminum

STANDARD FINISH

Aluminum Enameled

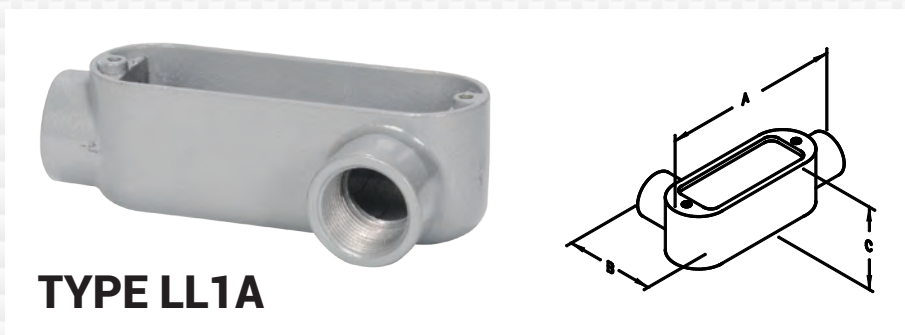

TYPE LL1A

CATALOG NUMBER	TRADE SIZE	DIM A	DIM B	DIM C	MAX WIRE SIZE	VOL. CU.IN.	UNIT PACK	MASTER PACK	LBS. / 100 PCS.	UPC #
LL Type										
LL1A	1/2"	4.31	2.06	1.38	N/A	4.35	10	50	25	41015
LL2A	3/4"	5.06	2.25	1.63	3 #6 AWG	7.30	10	50	37	41025
LL3A	1"	5.87	2.63	1.88	3 #4 AWG	12.20	5	25	45	41035
LL4A	1-1/4"	7.81	3.63	2.50	3 #2 AWG	35.80	-	10	98	41045
LL5A	1-1/2"	7.81	3.63	2.50	3 #1/0 AWAG	35.80	-	10	92	41055
LL6A	2"	10.06	4.44	3.38	3 #4/0 AWG	69.70	-	5	245	41065
LL7A	2-1/2"	12.81	5.75	4.00	3 #300 MCM	69.70	-	1	388	41075
LL8A	3"	12.81	5.75	4.50	3 #350 MCM	186.00	-	1	439	41085
LL9A	3-1/2"	15.62	11.69	5.63	3 #350 MCM	306.00	-	1	924	41095
LL10A	4"	15.62	11.69	5.63	3 #350 MCM	308.00	-	1	882	41105



TYPE LR1A

CATALOG NUMBER	TRADE SIZE	DIM A	DIM B	DIM C	MAX WIRE SIZE	VOL. CU.IN.	UNIT PACK	MASTER PACK	LBS. / 100 PCS.	UPC #
LR Type										
LR1A	1/2"	4.31	2.06	1.38	N/A	4.35	10	50	23	42015
LR2A	3/4"	5.06	2.25	1.63	3 #6 AWG	7.30	10	50	38	42025
LR3A	1"	5.87	2.63	1.88	3 #4 AWG	12.20	5	25	49	42035
LR4A	1-1/4"	7.81	3.63	2.50	3 #2 AWG	35.80	-	10	98	42045
LR5A	1-1/2"	7.81	3.63	2.50	3 #1/0 AWAG	35.80	-	10	94	42055
LR6A	2"	10.06	4.44	3.38	3 #4/0 AWG	69.70	-	5	254	42065
LR7A	2-1/2"	12.81	5.75	4.00	3 #300 MCM	69.70	-	1	366	42075
LR8A	3"	12.81	5.75	4.50	3 #350 MCM	186.00	-	1	406	42085
LR9A	3-1/2"	15.62	11.69	5.63	3 #350 MCM	306.00	-	1	928	42095
LR10A	4"	15.62	11.69	5.63	3 #350 MCM	308.00	-	1	902	42105

ALUMINUM THREADED CONDUIT BODIES

FOR THREADED RIGID CONDUIT AND IMC

APPLICATION

To provide access to conductors for pulling, splicing, and maintenance. Threaded for rigid conduit and IMC

FEATURES

- Tapered threaded hubs (NPT)
- Raintight when used with gasketed covers
- Die cast from high-strength, corrosion and weather resistant, copper-free aluminum alloy.
- Flat back design for easy mounting close to walls

STANDARD MATERIALS

1/2" - 2"
Die cast/Copper-free Aluminum
2-1/2" - 4"
Sand-cast/Copper-free Aluminum

STANDARD FINISH

Aluminum Enameled



TYPE T1A

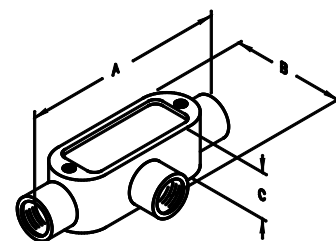

CATALOG NUMBER	TRADE SIZE	DIM A	DIM B	DIM C	MAX WIRE SIZE	VOL. CU.IN.	UNIT PACK	MASTER PACK	LBS. / 100 PCS.	UPC #
T Type										
T1A	1/2"	4.75	2.06	1.38	N/A	4.35	10	50	23	44015
T2A	3/4"	5.56	2.25	1.63	3 #6 AWG	7.25	10	50	38	44025
T3A	1"	6.44	2.63	1.88	3 #4 AWG	12.20	5	25	53	44035
T4A	1-1/4"	8.25	3.56	2.50	3 #2 AWG	33.10	-	10	100	44045
T5A	1-1/2"	8.38	3.56	2.50	3 #1/0 AWAG	33.10	-	10	98	44055
T6A	2"	10.69	4.38	3.13	3 #4/0 AWG	67.00	-	5	265	44065
T7A	2-1/2"	13.25	5.75	4.00	3 #4/0 AWG	67.00	-	1	375	44075
T8A	3"	13.25	5.75	4.50	3 #4/0 AWG	175.00	-	1	444	44085
T9A	3-1/2"	16.13	7.69	5.63	3 #400 MCM	298.00	-	1	1146	44095
T10A	4"	16.13	7.69	5.63	3 #400 MCM	300.00	-	1	1079	44105

ALUMINUM THREADED CONDUIT BODIES WITH COVER AND GASKET

FOR THREADED RIGID CONDUIT AND IMC

APPLICATION

To provide access to conductors for pulling, splicing, and maintenance. Threaded for rigid conduit and IMC

FEATURES

- Tapered threaded hubs (NPT)
- Assembled with neoprene gasket and stamped cover
- Die cast from high-strength, corrosion and weather resistant, copper-free aluminum alloy.
- Flat back design for easy mounting close to walls

STANDARD MATERIALS

1/2" - 2"
Die cast/Copper-free Aluminum
2-1/2" - 4"
Sand-cast/Copper-free Aluminum

STANDARD FINISH

Aluminum Enameled



TYPE C1ACG

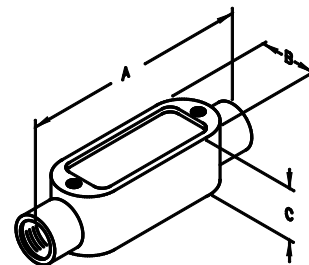

CATALOG NUMBER	TRADE SIZE	DIM A	DIM B	DIM C	MAX WIRE SIZE	VOL. CU.IN.	UNIT PACK	MASTER PACK	LBS. / 100 PCS.	UPC #
C Type										
C1ACG	1/2"	4.69	1.38	1.31	N/A	4.35	10	50	21	10079
C2ACG	3/4"	5.50	1.56	1.63	3 #6 AWG	7.30	10	50	33	10080
C3ACG	1"	6.48	1.88	1.88	3 #4 AWG	12.20	5	25	46	10081
C4ACG	1-1/4"	8.31	2.50	2.50	3 #2 AWG	33.50	-	10	82	10082
C5ACG	1-1/2"	8.38	2.50	2.50	3 #1/0 AWG	33.50	-	10	85	10083
C6ACG	2"	10.31	3.38	3.38	3 #4/0 AWG	69.50	-	5	188	10084
C7ACG	2-1/2"	13.12	4.50	4.00	3 #250 MCM	69.50	-	1	325	10085
C8ACG	3"	13.19	4.56	4.56	3 #250 MCM	188.00	-	1	399	10086
C9ACG	3-1/2"	16.12	5.69	5.63	3 #300 MCM	307.00	-	1	975	10087
C10ACG	4"	16.12	5.69	5.63	3 #300 MCM	309.00	-	1	875	10088



TYPE LB1ACG

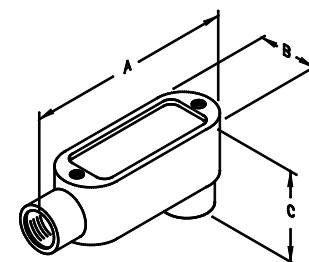

CATALOG NUMBER	TRADE SIZE	DIM A	DIM B	DIM C	MAX WIRE SIZE	VOL. CU.IN.	UNIT PACK	MASTER PACK	LBS. / 100 PCS.	UPC #
LB Type										
LB1ACG	1/2"	4.31	1.31	2.19	N/A	4.35	10	50	24	10059
LB2ACG	3/4"	5.06	1.56	2.44	3 #6 AWG	7.25	10	50	37	10060
LB3ACG	1"	5.87	1.75	2.75	3 #4 AWG	12.20	5	25	46	10118
LB4ACG	1-1/4"	7.81	2.50	3.44	3 #2 AWG	32.30	-	10	98	10062
LB5ACG	1-1/2"	7.81	2.50	3.44	3 #2 AWG	33.80	-	10	91	10063
LB6ACG	2"	10.06	3.12	4.31	3 #4/0 AWG	71.20	-	5	222	10064
LB7ACG	2-1/2"	12.81	4.50	5.31	3 #4/0 AWG	71.20	-	1	366	10065
LB8ACG	3"	12.81	4.50	5.94	3 #4/0 AWG	183.50	-	1	430	10066
LB9ACG	3-1/2"	15.62	5.56	7.06	3 #400 MCM	304.90	-	1	937	10067
LB10ACG	4"	15.62	5.56	7.06	3 #400 MCM	308.00	-	1	851	10068

ALUMINUM THREADED CONDUIT BODIES WITH COVER AND GASKET

FOR THREADED RIGID CONDUIT AND IMC

APPLICATION

To provide access to conductors for pulling, splicing, and maintenance. Threaded for rigid conduit and IMC

FEATURES

- Tapered threaded hubs (NPT)
- Assembled with neoprene gasket and stamped cover
- Die cast from high-strength, corrosion and weather resistant, copper-free aluminum alloy.
- Flat back design for easy mounting close to walls

STANDARD MATERIALS

1/2" - 2"
Die cast/Copper-free Aluminum
2-1/2" - 4"
Sand-cast/Copper-free Aluminum

STANDARD FINISH

Aluminum Enameled



TYPE LL1ACG

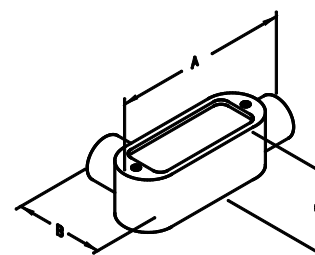

CATALOG NUMBER	TRADE SIZE	DIM A	DIM B	DIM C	MAX WIRE SIZE	VOL. CU.IN.	UNIT PACK	MASTER PACK	LBS. / 100 PCS.	UPC #
LL Type										
LL1ACG	1/2"	4.31	2.06	1.38	N/A	4.35	10	50	25	10089
LL2ACG	3/4"	5.06	2.25	1.63	3 #6 AWG	7.30	10	50	37	10090
LL3ACG	1"	5.87	2.63	1.88	3 #4 AWG	12.20	5	25	45	10091
LL4ACG	1-1/4"	7.81	3.63	2.50	3 #2 AWG	35.80	-	10	98	10092
LL5ACG	1-1/2"	7.81	3.63	2.50	3 #1/0 AWG	35.80	-	10	92	10093
LL6ACG	2"	10.06	4.44	3.38	3 #4/0 AWG	69.70	-	5	245	10094
LL7ACG	2-1/2"	12.81	5.75	4.00	3 #300 MCM	69.70	-	1	388	10095
LL8ACG	3"	12.81	5.75	4.50	3 #350 MCM	186.00	-	1	439	10096
LL9ACG	3-1/2"	15.62	11.69	5.63	3 #350 MCM	306.00	-	1	924	10097
LL10ACG	4"	15.62	11.69	5.63	3 #350 MCM	308.00	-	1	882	10098



TYPE LR1ACG

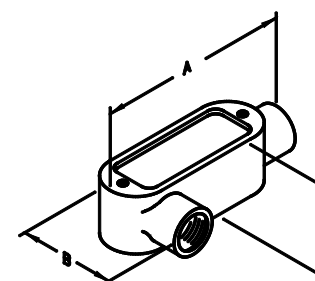

CATALOG NUMBER	TRADE SIZE	DIM A	DIM B	DIM C	MAX WIRE SIZE	VOL. CU.IN.	UNIT PACK	MASTER PACK	LBS. / 100 PCS.	UPC #
LR Type										
LR1ACG	1/2"	4.31	2.06	1.38	N/A	4.35	10	50	23	10099
LR2ACG	3/4"	5.06	2.25	1.63	3 #6 AWG	7.30	10	50	38	10100
LR3ACG	1"	5.87	2.63	1.88	3 #4 AWG	12.20	5	25	49	10101
LR4ACG	1-1/4"	7.81	3.63	2.50	3 #2 AWG	35.80	-	10	98	10102
LR5ACG	1-1/2"	7.81	3.63	2.50	3 #1/0 AWG	35.80	-	10	94	10103
LR6ACG	2"	10.06	4.44	3.38	3 #4/0 AWG	69.70	-	5	254	10104
LR7ACG	2-1/2"	12.81	5.75	4.00	3 #300 MCM	69.70	-	1	366	10105
LR8ACG	3"	12.81	5.75	4.50	3 #350 MCM	186.00	-	1	406	10106
LR9ACG	3-1/2"	15.62	11.69	5.63	3 #350 MCM	306.00	-	1	928	10107
LR10ACG	4"	15.62	11.69	5.63	3 #350 MCM	308.00	-	1	902	10108

ALUMINUM THREADED CONDUIT BODIES WITH COVER AND GASKET

FOR THREADED RIGID CONDUIT AND IMC

APPLICATION

To provide access to conductors for pulling, splicing, and maintenance. Threaded for rigid conduit and IMC

FEATURES

- Tapered threaded hubs (NPT)
- Assembled with neoprene gasket and stamped cover
- Die cast from high-strength, corrosion and weather resistant, copper-free aluminum alloy.
- Flat back design for easy mounting close to walls

STANDARD MATERIALS

1/2" - 2"
Die cast/Copper-free Aluminum
2-1/2" - 4"
Sand-cast/Copper-free Aluminum

STANDARD FINISH

Aluminum Enameled



CATALOG NUMBER	TRADE SIZE	DIM A	DIM B	DIM C	MAX WIRE SIZE	VOL. CU.IN.	UNIT PACK	MASTER PACK	LBS. / 100 PCS.	UPC #
T Type										
T1ACG	1/2"	4.75	2.06	1.38	N/A	4.35	10	50	23	10069
T2ACG	3/4"	5.56	2.25	1.63	3 #6 AWG	7.25	10	50	38	10070
T3ACG	1"	6.44	2.63	1.88	3 #4 AWG	12.20	5	25	53	10071
T4ACG	1-1/4"	8.25	3.56	2.50	3 #2 AWG	33.10	-	10	100	10072
T5ACG	1-1/2"	8.38	3.56	2.50	3 #1/0 AWG	33.10	-	10	98	10073
T6ACG	2"	10.69	4.38	3.13	3 #4/0 AWG	67.00	-	5	265	10074
T7ACG	2-1/2"	13.25	5.75	4.00	3 #4/0 AWG	67.00	-	1	375	10075
T8ACG	3"	13.25	5.75	4.50	3 #4/0 AWG	175.00	-	1	444	10076
T9ACG	3-1/2"	16.13	7.69	5.63	3 #400 MCM	298.00	-	1	1146	10077
T10ACG	4"	16.13	7.69	5.63	3 #400 MCM	300.00	-	1	1079	10078

ALUMINUM COMBINATION CONDUIT BODIES WITH COVER AND GASKET

FOR THREADED RIGID CONDUIT, IMC AND EMT

APPLICATION

Used with threaded rigid conduit, IMC, and EMT for providing access to the interior of a conduit system for pulling, splicing, inspection and maintenance.

FEATURES

- Assembled with slotted/ Robertson combination screws.
- Assembled with neoprene gasket and stamped cover.
- Tapered threaded hubs (NPT).
- Die cast from high-strength, corrosion and weather resistant, copper-free aluminum alloy.
- Flat back design for easy mounting close to walls.
- Suitable for use in concrete.

STANDARD MATERIALS

Die cast/Copper-free Aluminum

STANDARD FINISH

Aluminum Enameled



TYPE C1CA

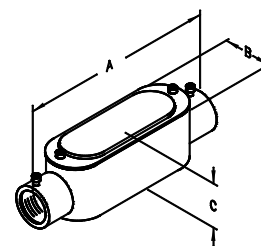

CATALOG NUMBER	TRADE SIZE	DIM A	DIM B	DIM C	MAX WIRE SIZE	VOL. CU.IN.	UNIT PACK	MASTER PACK	LBS. / 100 PCS.	UPC #
C Type										
C1CA	1/2"	4.69	1.38	1.56	N/A	4.35	10	50	28	64401
C2CA	3/4"	5.50	1.56	1.75	3 #6 AWG	7.30	10	50	41	64402
C3CA	1"	6.48	1.88	2.13	3 #4 AWG	12.20	5	25	56	64403
C4CA	1-1/4"	8.31	2.50	2.75	3 #2 AWG	33.50	-	10	101	64404
C5CA	1-1/2"	8.38	2.50	2.75	3 #1/0 AWG	33.50	-	10	104	64405
C6CA	2"	10.31	3.38	3.63	3 #4/0 AWG	69.50	-	5	220	64406



TYPE LB1CA

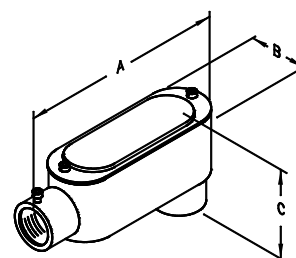

CATALOG NUMBER	TRADE SIZE	DIM A	DIM B	DIM C	MAX WIRE SIZE	VOL. CU.IN.	UNIT PACK	MASTER PACK	LBS. / 100 PCS.	UPC #
LB Type										
LB1CA	1/2"	4.31	1.31	2.44	N/A	4.35	10	50	24	64101
LB2CA	3/4"	5.06	1.56	2.69	3 #6 AWG	7.25	10	50	37	64102
LB3CA	1"	5.87	1.75	3.00	3 #4 AWG	12.20	5	25	46	64103
LB4CA	1-1/4"	7.81	2.50	3.69	3 #2 AWG	32.30	-	10	98	64104
LB5CA	1-1/2"	7.81	2.50	3.69	3 #2 AWG	33.80	-	10	91	64105
LB6CA	2"	10.06	3.12	4.56	3 #4/0 AWG	71.20	-	5	222	64106

ALUMINUM COMBINATION CONDUIT BODIES WITH COVER AND GASKET

FOR THREADED RIGID CONDUIT, IMC AND EMT

APPLICATION

Used with threaded rigid conduit, IMC, and EMT for providing access to the interior of a conduit system for pulling, splicing, inspection and maintenance.

FEATURES

- Assembled with slotted/ Robertson combination screws.
- Assembled with neoprene gasket and stamped cover.
- Tapered threaded hubs (NPT).
- Die cast from high-strength, corrosion and weather resistant, copper-free aluminum alloy.
- Flat back design for easy mounting close to walls.
- Suitable for use in concrete.

STANDARD MATERIALS

Die cast/Copper-free Aluminum

STANDARD FINISH

Aluminum Enameled



TYPE LL1CA

CATALOG NUMBER	TRADE SIZE	DIM A	DIM B	DIM C	MAX WIRE SIZE	VOL. CU.IN.	UNIT PACK	MASTER PACK	LBS. / 100 PCS.	UPC #
LL Type										
LL1CA	1/2"	4.31	2.06	1.63	N/A	4.35	10	50	25	64201
LL2CA	3/4"	5.06	2.25	1.88	3 #6 AWG	7.30	10	50	37	64202
LL3CA	1"	5.87	2.63	2.13	3 #4 AWG	12.20	5	25	45	64203
LL4CA	1-1/4"	7.81	3.63	2.75	3 #2 AWG	35.80	-	10	98	64204
LL5CA	1-1/2"	7.81	3.63	2.75	3 #1/0 AWG	35.80	-	10	92	64205
LL6CA	2"	10.06	4.44	3.63	3 #4/0 AWG	69.70	-	5	245	64206

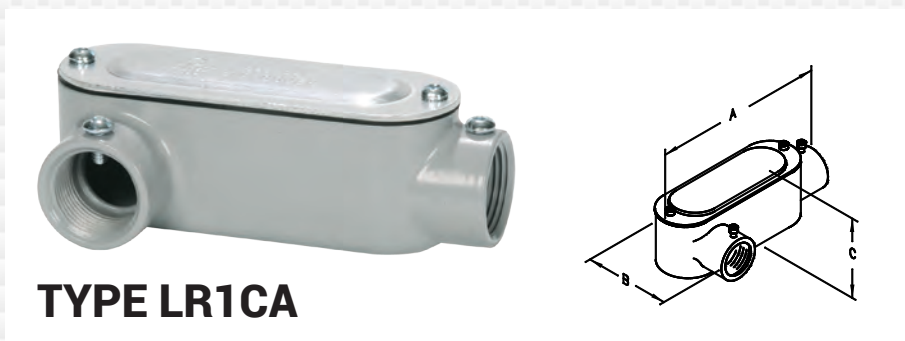

TYPE LR1CA

CATALOG NUMBER	TRADE SIZE	DIM A	DIM B	DIM C	MAX WIRE SIZE	VOL. CU.IN.	UNIT PACK	MASTER PACK	LBS. / 100 PCS.	UPC #
LR Type										
LR1CA	1/2"	4.31	2.06	1.63	N/A	4.35	10	50	23	64301
LR2CA	3/4"	5.06	2.25	1.88	3 #6 AWG	7.30	10	50	38	64302
LR3CA	1"	5.87	2.63	2.13	3 #4 AWG	12.20	5	25	49	64303
LR4CA	1-1/4"	7.81	3.63	2.75	3 #2 AWG	35.80	-	10	98	64304
LR5CA	1-1/2"	7.81	3.63	2.75	3 #1/0 AWG	35.80	-	10	94	64305
LR6CA	2"	10.06	4.44	3.63	3 #4/0 AWG	69.70	-	5	254	64306

ALUMINUM COMBINATION CONDUIT BODIES WITH COVER AND GASKET

FOR THREADED RIGID CONDUIT, IMC AND EMT

APPLICATION

Used with threaded rigid conduit, IMC, and EMT for providing access to the interior of a conduit system for pulling, splicing, inspection and maintenance.

FEATURES

- Assembled with slotted/ Robertson combination screws.
- Assembled with neoprene gasket and stamped cover.
- Tapered threaded hubs (NPT).
- Die cast from high-strength, corrosion and weather resistant, copper-free aluminum alloy.
- Flat back design for easy mounting close to walls.
- Suitable for use in concrete.

STANDARD MATERIALS

Die cast/Copper-free Aluminum

STANDARD FINISH

Aluminum Enameled

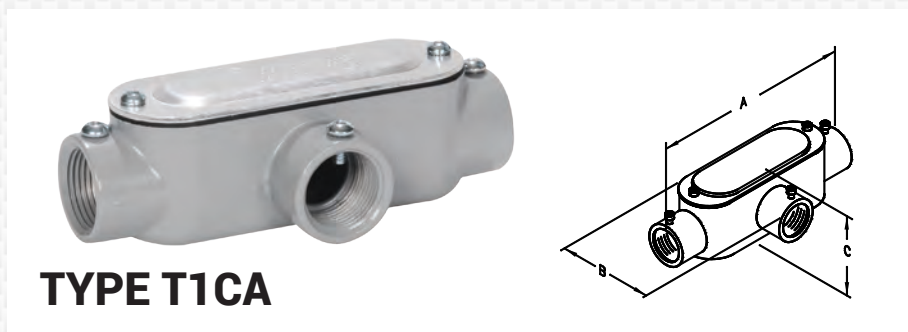

TYPE T1CA

CATALOG NUMBER	TRADE SIZE	DIM A	DIM B	DIM C	MAX WIRE SIZE	VOL. CU.IN.	UNIT PACK	MASTER PACK	LBS. / 100 PCS.	UPC #
T Type										
T1CA	1/2"	4.75	2.06	1.63	N/A	4.35	10	50	23	64501
T2CA	3/4"	5.56	2.25	1.88	3 #6 AWG	7.25	10	50	38	64502
T3CA	1"	6.44	2.63	2.13	3 #4 AWG	12.20	5	25	53	64503
T4CA	1-1/4"	8.25	3.56	2.75	3 #2 AWG	33.10	-	10	100	64504
T5CA	1-1/2"	8.38	3.56	2.75	3 #1/0 AWG	33.10	-	10	98	64505
T6CA	2"	10.69	4.38	3.63	3 #4/0 AWG	67.00	-	5	265	64506

CONDUIT BODY COVERS

STEEL AND ALUMINUM COVERS

APPLICATION

Used with conduit bodies to cover opening.

FEATURES

- Assembled with captive zinc plated steel screws.

STANDARD MATERIALS

Steel

STANDARD FINISH

Zinc plated



TYPE 02

CATALOG NUMBER	TRADE SIZE	DIM A	DIM B	UNIT PACK	MASTER PACK	LBS. / 100 PCS.	UPC #
Steel Covers							
01	1/2"	3.875	1.310	25	250	9	49017
02	3/4"	4.625	1.520	25	250	13	49027
03	1"	5.315	1.710	20	200	19	49037
04	1-1/4" - 1-1/2"	7.240	2.510	25	100	31	49047
05	2"	9.484	3.110	-	50	50	49057
06	2-1/2" - 3"	14.937	5.500	-	10	94	49067
07	3-1/2" - 4"	15.000	6.000	-	10	138	49077

APPLICATION

Used with conduit bodies to cover opening.

FEATURES

- Assembled with captive zinc plated steel screws.
- Stamped from high-strength aluminum, corrosion and weather resistant copperfree aluminum alloy.

STANDARD MATERIALS

Stamped Aluminum



TYPE 02A

CATALOG NUMBER	TRADE SIZE	DIM A	DIM B	UNIT PACK	MASTER PACK	LBS. / 100 PCS.	UPC #
Aluminum Covers							
01A	1/2"	3.90	1.37	25	250	6	49105
02A	3/4"	4.70	1.60	25	250	10	49205
03A	1"	5.40	1.78	20	200	14	49305
04A	1-1/4" - 1-1/2"	7.25	2.52	25	100	18	49405
05A	2"	9.50	3.11	-	50	20	49505
06A	2-1/2" - 3"	12.13	4.45	-	10	33	49605
07A	3-1/2" - 4"	14.94	5.50	-	10	62	49705

MALLEABLE IRON CONDUIT BODY COVERS

APPLICATION

Used with conduit bodies to cover opening.

FEATURES

- Supplied with Stainless Steel captive screws
- Sizes 2 1/2" thru 4" with raised dome affords additional wiring room

STANDARD MATERIALS

Malleable Iron

STANDARD FINISH

Zinc plated



OPTIONAL FINISH

For additional corrosion protection, specify Hot Dipped Galvanized. Add suffix 'G' to Malleable Iron catalog number. Example 01MG. For more information, see page 13.

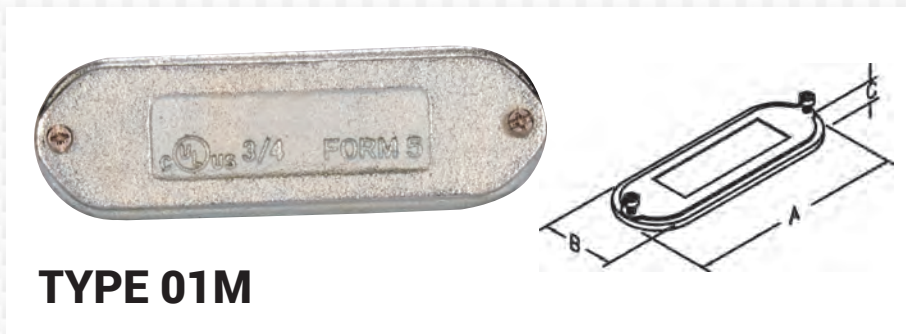

TYPE 01M

CATALOG NUMBER	TRADE SIZE	DIM A	DIM B	DIM C	UNIT PACK	MASTER PACK	LBS. / 100 PCS.	UPC #
Malleable Iron								
01M	1/2"	3.936	1.313	0.063	25	250	23	90131
02M	3/4"	4.625	1.500	0.063	25	250	31	90132
03M	1"	5.313	1.750	0.063	20	200	41	90133
04M	1-1/4" - 1-1/2"	7.188	2.500	0.250	25	100	91	90134
05M	2"	9.500	3.188	0.313	-	25	208	90135
06M	2-1/2" - 3"	12.125	4.313	1.063	-	10	358	90136
07M	3-1/2" - 4"	14.875	5.625	1.125	-	10	550	90137

MALLEABLE IRON/**HOT DIPPED GALVANIZED** CONDUIT BODY COVERS

APPLICATION

Used with conduit bodies to cover opening.

FEATURES

- Supplied with Stainless Steel captive screws
- Sizes 2 1/2" thru 4" with raised dome affords additional wiring room

STANDARD MATERIALS

Malleable Iron

STANDARD FINISH

Hot Dipped Galvanized/Zinc Plated

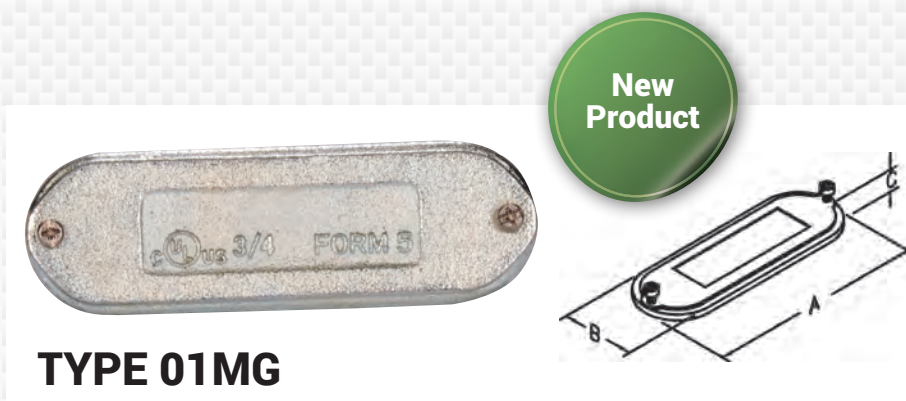

TYPE 01MG

CATALOG NUMBER	TRADE SIZE	DIM A	DIM B	DIM C	UNIT PACK	MASTER PACK	LBS. / 100 PCS.	UPC #
01MG	1/2"	3.936	1.313	0.063	25	250	23	70224
02MG	3/4"	4.625	1.500	0.063	25	250	31	70225
03MG	1"	5.313	1.750	0.063	20	200	41	70226
04MG	1-1/4" - 1-1/2"	7.188	2.500	0.250	25	100	91	70227
05MG	2"	9.500	3.188	0.313	-	25	208	70228
06MG	2-1/2" - 3"	12.125	4.313	1.063	-	10	358	70229
07MG	3-1/2" - 4"	14.875	5.625	1.125	-	10	550	70230

CONDUIT BODY COVERS

NEOPRENE GASKETS

APPLICATION

→ Gasket used with conduit bodies for a raintight seal.

STANDARD MATERIALS

Neoprene Rubber



TYPE 11

CATALOG NUMBER	TRADE SIZE	DIM A	DIM B	UNIT PACK	MASTER PACK	LBS. / 100 PCS.	UPC #
Neoprene Gaskets							
10	1/2"	3.90	1.37	200	2000	3	49910
11	3/4"	4.60	1.56	100	1000	3	49911
12	1"	5.34	1.73	100	1000	3	49912
13	1-1/4" - 1-1/2"	7.25	2.51	50	500	6	49913
14	2"	9.50	3.05	25	100	11	49914
15	2-1/2" - 3"	12.13	4.39	-	10	13	49915
16	3-1/2" - 4"	14.88	5.43	-	10	28	49916

FORM 7 CONDUIT BODY COVERS

FOR THREADED RIGID CONDUIT AND IMC

APPLICATION

Used with Form 7 conduit bodies to cover opening

FEATURES

- Covers with integral sealing gaskets are installed without the use of screws, reducing installation time and costs.
- Supplied with Stainless Steel captive screws
- Easy installation
- Easy removal

STANDARD MATERIALS

Steel / Stainless Steel Screws

STANDARD FINISH

Zinc Plated



New Product

CATALOG NUMBER	TRADE SIZE	DIM A	DIM B	DIM C	UNIT PACK	MASTER PACK	LBS. / 100 PCS.	UPC #
170	1/2"	3.66	1.35	0.27	50	250	11	10500
270	3/4"	4.29	1.55	0.27	50	250	16	10501
370	1"	5.03	1.79	0.28	25	200	21	10502
470	1-1/4"	5.57	2.19	0.28	20	100	29	10503
570	1-1/2"	6.06	2.45	0.28	20	100	33	10504
670	2"	7.07	3.01	0.28	-	50	44	10505
870	2-1/2" - 3"	9.06	4.25	0.50	-	10	113	10506
970	3-1/2" - 4"	11.00	5.31	0.64	-	10	150	10507

STANDARD MATERIALS

Gray Iron / Stainless Steel Screws

STANDARD FINISH

Zinc Plated



New Product

CATALOG NUMBER	TRADE SIZE	DIM A	DIM B	DIM C	UNIT PACK	MASTER PACK	LBS. / 100 PCS.	UPC #
170G	1/2"	3.66	1.35	0.37	50	250	31	10508
270G	3/4"	4.29	1.55	0.37	50	250	39	10509
370G	1"	5.03	1.79	0.47	25	200	58	10510
470G	1-1/4"	5.57	2.19	0.51	20	100	88	10511
570G	1-1/2"	6.06	2.45	0.57	20	100	108	10512
670G	2"	7.07	3.01	0.58	-	25	165	10513
870G	2-1/2" - 3"	9.06	4.25	0.58	-	10	220	10514
970G	3-1/2" - 4"	11.00	5.31	0.64	-	10	265	10515

MALLEABLE IRON INSULATED GROUNDING BUSHINGS

FOR THREADED RIGID CONDUIT AND IMC

APPLICATION

Used with a locknut to terminate threaded rigid and IMC conduit to a box or enclosure and to provide a smooth pulling surface. Thermoplastic liner prevents damage to wire insulation. Liner rated at 150°C.

FEATURES

- The plastic liner won't chip, crack, swell or shrink. It resists corrosion, chemicals, and temperature extremes.
- Set-screw provided with each fitting locks bushing in any desired position.
- UL Listed for use with Copper or Aluminum Grounding Conductors.

STANDARD MATERIALS

Malleable Iron/Open side tin plated aluminum lug.

STANDARD FINISH

Zinc plated

Optional Lug: Available with copper lug; use suffix C instead of L. Example 20BI4C.



OPTIONAL FINISH

For additional corrosion protection, specify Hot Dipped Galvanized. Add suffix 'G' to Malleable Iron catalog number. Example 20BI4LG. For more information, see page 14.



TYPE 25BI4L

CATALOG NUMBER	TRADE SIZE	GROUNDING LUG CAPACITY	DIM A	DIM B	DIM C	UNIT PACK	MASTER PACK	LBS. / 100 PCS.	UPC #
Threaded									
20BI4L	1/2"	#14 - #4	1.34	1.19	0.61	100	1000	7	20006
21BI4L	3/4"	#14 - #4	1.47	1.45	0.64	50	500	11	20013
22BI4L	1"	#14 - #4	1.63	1.76	0.72	25	250	15	20019
23BI4L	1-1/4"	#14 - #4	1.80	2.10	0.74	25	250	18	20025
24BI4L	1-1/2"	#14 - #4	2.11	2.33	0.80	25	250	23	20033
25BI0L	2"	#14 - #2/0	2.55	2.79	0.85	25	250	32	25012
25BI4L	2"	#14 - #4	2.34	2.79	0.85	25	250	28	25011
26BI0L	2-1/2"	#14 - #2/0	2.84	3.33	1.10	-	10	57	25017
26BI40L	2-1/2"	#6 - #250MCM	3.47	3.33	1.10	-	10	70	25018
27BI0L	3"	#14 - #2/0	3.11	3.87	1.10	-	10	73	25029
27BI40L	3"	#6 - #250MCM	3.74	3.87	1.10	-	10	85	25030
28BI0L	3-1/2"	#14 - #2/0	3.38	4.42	1.10	-	10	88	28043
28BI40L	3-1/2"	#6 - #250MCM	4.02	4.42	1.10	-	10	90	28044
29BI0L	4"	#14 - #2/0	3.62	4.89	1.10	-	10	118	28055
29BI40L	4"	#6 - #250MCM	4.25	4.89	1.10	-	10	121	28056
30BI40L	5"	#6 - #250MCM	4.80	6.00	1.13	-	10	165	28067
31BI40L	6"	#6 - #250MCM	5.46	7.31	1.13	-	10	203	28068

MALLEABLE IRON/**HOT DIPPED GALVANIZED** INSULATED GROUNDING BUSHINGS

FOR THREADED RIGID CONDUIT AND IMC



APPLICATION

Used with a locknut to terminate threaded rigid and IMC conduit to a box or enclosure and to provide a smooth pulling surface. Thermoplastic liner prevents damage to wire insulation. Liner rated at 150°C.

FEATURES

- The plastic liner won't chip, crack, swell or shrink. It resists corrosion, chemicals, and temperature extremes.
- Set-screw provided with each fitting locks bushing in any desired position.
- UL Listed for use with Copper or Aluminum Grounding Conductors.



TYPE 25BI4LG

STANDARD MATERIALS

Malleable Iron/Open side tin plated aluminum lug.

STANDARD FINISH

Hot Dipped Galvanized/Zinc Plated

Optional Lug: Available with copper lug; use suffix C instead of L. Example 21BI4CG.



OPTIONAL FINISH

For Malleable Iron / Zinc Plated, please remove suffix 'G' from Hot Dipped Galvanized Catalog Number and see page 57.

CATALOG NUMBER	TRADE SIZE	GROUNDING LUG CAPACITY	DIM A	DIM B	DIM C	UNIT PACK	MASTER PACK	LBS. / 100 PCS.	UPC #
Threaded									
20BI4LG	1/2"	#14 - #4	1.34	1.19	0.61	100	1000	7	10021
21BI4LG	3/4"	#14 - #4	1.47	1.45	0.64	50	500	11	10022
22BI4LG	1"	#14 - #4	1.63	1.76	0.72	25	250	15	10023
23BI4LG	1-1/4"	#14 - #4	1.80	2.10	0.74	25	250	18	10024
24BI4LG	1-1/2"	#14 - #4	2.11	2.33	0.80	25	250	23	10025
25BI4LG	2"	#14 - #4	2.34	2.79	0.85	25	250	28	10026
26BIOLG	2-1/2"	#14 - #2/0	2.84	3.33	1.10	-	10	57	10027
26BI4OLG	2-1/2"	#6 - #250MCM	3.47	3.33	1.10	-	10	70	10028
27BIOLG	3"	#14 - #2/0	3.11	3.87	1.10	-	10	73	10029
27BI4OLG	3"	#6 - #250MCM	3.74	3.87	1.10	-	10	85	10030
28BIOLG	3-1/2"	#14 - #2/0	3.38	4.42	1.10	-	10	88	10031
28BI4OLG	3-1/2"	#6 - #250MCM	4.02	4.42	1.10	-	10	90	10032
29BIOLG	4"	#14 - #2/0	3.62	4.89	1.10	-	10	118	10033
29BI4OLG	4"	#6 - #250MCM	4.25	4.89	1.10	-	10	121	10034
30BI4OLG	5"	#6 - #250MCM	4.80	6.00	1.13	-	10	165	10036
31BI4OLG	6"	#6 - #250MCM	5.46	7.31	1.13	-	10	203	10038

MALLEABLE IRON THREADLESS INSULATED GROUNDING BUSHINGS

FOR THREADLESS RIGID CONDUIT AND IMC

APPLICATION

Used with a locknut to terminate threadless rigid and IMC conduit to a box or enclosure and to provide a smooth pulling surface. Thermoplastic liner prevents damage to wire insulation. Liner rated at 150°C.

FEATURES

- The plastic liner won't chip, crack, swell or shrink. It resists corrosion, chemicals, and temperature extremes.
- Set-screw provided with each fitting locks bushing in any desired position.
- UL Listed for use with Copper or Aluminum Grounding Conductors.

STANDARD MATERIALS

Malleable Iron/Open side tin plated aluminum lug.

STANDARD FINISH

Zinc plated



CATALOG NUMBER	TRADE SIZE	GROUNDING LUG CAPACITY	DIM A	DIM B	DIM C	UNIT PACK	MASTER PACK	LBS. / 100 PCS.	UPC #
Set-Screw									
20BI4LSS	1/2"	#14-#4	1.19	0.61	0.61	100	1000	7	12700
21BI4LSS	3/4"	#14-#4	1.44	0.64	0.64	50	500	11	12701
22BI4LSS	1"	#14-#4	1.75	0.72	0.72	25	250	15	12702
23BI4LSS	1-1/4"	#14-#4	2.13	0.74	0.74	25	250	18	12703
24BI4LSS	1-1/2"	#14-#4	2.31	0.80	0.80	25	250	23	12704
25BI4LSS	2"	#14-#4	2.81	0.85	0.85	25	250	28	29405
26BI0LSS	2-1/2"	#14-#1/0	3.38	1.10	0.85	-	10	57	12706
26BI40LSS	2-1/2"	#6-#250MCM	3.38	1.10	1.10	-	10	70	29406
27BI0LSS	3"	#14-#2/0	4.06	1.10	1.10	-	10	73	12707
27BI40LSS	3"	#6-#250MCM	4.06	1.10	1.10	-	10	85	29407
28BI0LSS	3-1/2"	#14-#2/0	4.50	1.10	1.10	-	10	88	12708
28BI40LSS	3-1/2"	#6-#250MCM	4.50	1.10	1.10	-	10	90	29408
29BI0LSS	4"	#14-#2/0	5.19	1.10	1.10	-	10	118	12709
29BI40LSS	4"	#6-#250MCM	5.19	1.10	1.10	-	10	121	29409
30BI40LSS	5"	#6-#250MCM	6.60	1.13	1.10	-	10	165	29410
31BI40LSS	6"	#6-#250MCM	7.18	1.13	1.13	-	10	203	29411

SPECIFICATION GRADE BRONZE INSULATED GROUNDING BUSHING

FOR THREADED RIGID CONDUIT AND IMC



APPLICATION

To protect insulated conductors from abrasion during pulling and from mechanical vibration.

To provide voltage gradient between live conductors and ground at point of electrical and mechanical stress on conductor insulation.

FEATURES

- Molded-on high impact phenolic thermosetting insulation
- UL insulation temperature rating 150°C
- Positive metallic conduit stop
- For Highly corrosive atmospheres

STANDARD MATERIALS

Bushing: Bronze
Lug: Copper
Screws: Stainless Steel

STANDARD FINISH

Lug: Tin Plated



TYPE BRLG-1504



CATALOG NUMBER	TRADE SIZE	DIM A	DIM B	DIM C	DIM D	DIM E	DIM F	UNIT PACK	MASTER PACK	LBS./100 PCS.	UPC #
BRLG-1504	1-1/2"	1.504	2.315	0.768	1.669	1/4"-28UNF	#10-24UNC	-	25	35	10670
BRLG-2004	2"	2.000	2.752	0.768	1.900	1/4"-28UNF	#10-24UNC	-	25	35	10675
BRLG-3104	3"	3.024	4.031	1.039	2.531	1/4"-28UNF	#10-24UNC	-	10	85	10680

ZINC INSULATED GROUNDING BUSHINGS

FOR THREADED RIGID CONDUIT AND IMC

APPLICATION

Used with a locknut to terminate threaded rigid and IMC conduit to a box or enclosure and to provide a smooth pulling surface. Thermoplastic liner prevents damage to wire insulation. Liner rated at 150°C.

FEATURES

- The plastic liner won't chip, crack, swell or shrink. It resists corrosion, chemicals, and temperature extremes.
- Set-screw provided with each fitting locks bushing in any desired position.
- UL Listed for use with Copper or Aluminum Grounding Conductors.

STANDARD MATERIALS

Zinc Die Cast/Open side tin plated aluminum lug.



CATALOG NUMBER	TRADE SIZE	GROUNDING LUG CAPACITY	DIM A	DIM B	DIM C	UNIT PACK	MASTER PACK	LBS. / 100 PCS.	UPC #
20BIZ4L	1/2"	#14 - #4	1.313	1.063	0.500	100	1000	4	20009
21BIZ4L	3/4"	#14 - #4	1.406	1.281	0.500	50	500	6	20016
22BIZ4L	1"	#14 - #4	1.563	1.531	0.596	25	250	8	20022
23BIZ4L	1-1/4"	#14 - #4	1.750	1.875	0.625	25	250	14	20028
24BIZ4L	1-1/2"	#14 - #4	2.031	2.156	0.625	25	250	16	20038
25BIZ4L	2"	#14 - #4	2.281	2.625	0.625	25	250	23	25007
25BIZ0L	2"	#14 - #1/0	2.500	2.625	0.625	25	250	26	25008
26BIZ0L	2-1/2"	#14 - #1/0	2.875	3.219	0.875	-	10	39	25023
26BIZ40L	2-1/2"	#6 - #250MCM	3.156	3.219	0.875	-	10	43	25024
27BIZ0L	3"	#14 - #1/0	3.313	3.813	0.875	-	10	46	25035
27BIZ40L	3"	#6 - #250MCM	3.625	3.813	0.875	-	10	51	25036
28BIZ0L	3-1/2"	#14 - #1/0	3.718	4.344	0.875	-	10	50	28049
28BIZ40L	3-1/2"	#6 - #250MCM	3.875	4.344	0.875	-	10	56	28050
29BIZ0L	4"	#14 - #1/0	3.968	4.813	0.875	-	10	58	28061
29BIZ40L	4"	#6 - #250MCM	4.125	4.813	0.875	-	10	65	28062

MALLEABLE IRON INSULATED BUSHINGS

FOR RIGID CONDUIT AND IMC

APPLICATION

Used with a locknut to terminate threaded/threadless rigid and IMC conduit to a box or enclosure and to provide a smooth pulling surface. Thermoplastic liner prevents damage to wire insulation. Liner rated at 150°C.

FEATURES

→ The plastic liner won't chip, crack, swell or shrink. It resists corrosion, chemicals, and temperature extremes.

STANDARD MATERIALS

Malleable Iron

STANDARD FINISH

Zinc plated



For Threaded Rigid Conduit and IMC

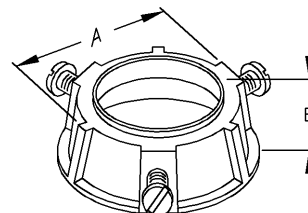

TYPE 1206

CATALOG NUMBER	TRADE SIZE	DIM A	DIM B	UNIT PACK	MASTER PACK	LBS. / 100 PCS.	UPC #
1206	1/2"	1.19	0.50	100	1000	6	12061
1207	3/4"	1.44	0.56	100	500	9	12071
1208	1"	1.75	0.63	50	500	13	12081
1209	1-1/4"	2.13	0.75	25	250	17	12091
1210	1-1/2"	2.31	0.88	25	250	21	12101
1211	2"	2.81	0.94	-	25	25	12111
1212	2-1/2"	3.38	1.00	-	25	51	12121
1213	3"	4.06	1.13	-	25	66	12131
1214	3-1/2"	4.50	1.19	-	25	72	12141
1215	4"	5.19	1.31	-	25	103	12151
1216	5"	6.06	1.31	-	10	147	12161
1217	6"	7.15	1.31	-	10	184	12171

Also available with lay-in lugs. See page 57.

For Threadless Rigid Conduit and IMC

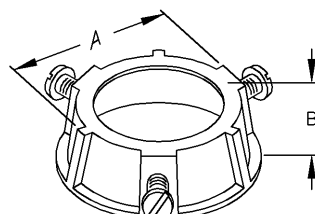

TYPE 1206SS

CATALOG NUMBER	TRADE SIZE	DIM A	DIM B	UNIT PACK	MASTER PACK	LBS. / 100 PCS.	UPC #
1206SS	1/2"	1.19	0.50	100	1000	6	12206
1207SS	3/4"	1.44	0.56	100	500	9	12207
1208SS	1"	1.75	0.63	50	500	13	12208
1209SS	1-1/4"	2.13	0.75	25	250	17	12209
1210SS	1-1/2"	2.31	0.81	25	250	21	12210
1211SS	2"	2.81	0.88	-	25	25	12221
1212SS	2-1/2"	3.35	1.10	-	25	51	12222
1213SS	3"	4.06	1.10	-	25	66	12223
1214SS	3-1/2"	4.50	1.10	-	25	72	12224
1215SS	4"	5.19	1.10	-	25	103	12225
1216SS	5"	6.00	1.13	-	10	147	12226
1217SS	6"	7.18	1.13	-	10	184	12227

Also available with lay-in lugs. See page 59.

ZINC INSULATED BUSHINGS

FOR THREADED RIGID CONDUIT AND IMC

APPLICATION

Used with a locknut to terminate threaded rigid and IMC conduit to a box or enclosure and to provide a smooth pulling surface. Thermoplastic liner prevents damage to wire insulation. Liner rated at 150°C.

FEATURES

- The plastic liner won't chip, crack, swell or shrink. It resists corrosion, chemicals, and temperature extremes.

STANDARD MATERIALS

Zinc Die Cast



TYPE 1207Z

CATALOG NUMBER	TRADE SIZE	DIM A	DIM B	UNIT PACK	MASTER PACK	LBS. / 100 PCS.	UPC #
1206Z	1/2"	1.15	0.47	100	1000	3	12062
1207Z	3/4"	1.41	0.47	100	500	4	12072
1208Z	1"	1.68	0.54	50	500	7	12082
1209Z	1-1/4"	1.94	0.60	25	250	15	12092
1210Z	1-1/2"	2.20	0.62	25	250	19	12102
1211Z	2"	2.80	0.62	-	25	22	12112
1212Z	2-1/2"	3.32	0.93	-	25	42	12122
1213Z	3"	3.94	0.93	-	25	51	12132
1214Z	3-1/2"	4.45	0.94	-	25	68	12142
1215Z	4"	5.00	0.97	-	25	98	12152

Also available with lay-in lugs. See page 61.

MALLEABLE IRON AND ZINC CONDUIT BUSHINGS

FOR THREADED RIGID CONDUIT AND IMC

APPLICATION

Used with a locknut to terminate threaded rigid and IMC conduit to a box or enclosure.

FEATURES

- Bushing surface rounded to prevent damage to wire insulation during pulling.

STANDARD MATERIALS

Malleable Iron

STANDARD FINISH

Zinc plated



Malleable Iron

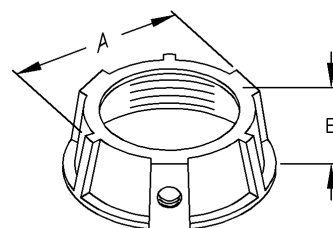

TYPE 806

CATALOG NUMBER	TRADE SIZE	DIM A	DIM B	UNIT PACK	MASTER PACK	LBS. / 100 PCS.	UPC #
806	1/2"	1.06	0.38	100	1000	6	18061
807	3/4"	1.25	0.44	100	1000	9	18071
808	1"	1.50	0.56	50	500	13	18081
809	1-1/4"	1.88	0.75	25	250	16	18091
810	1-1/2"	2.19	0.69	25	250	21	18101
811	2"	2.63	0.81	-	25	25	18111
812	2-1/2"	3.13	0.81	-	25	50	18121
814	3"	3.75	1.00	-	25	66	18141
815	3-1/2"	4.31	1.00	-	25	71	18151
816	4"	4.88	1.00	-	25	102	18161
817	5"	6.13	1.13	-	10	146	18171
818	6"	7.19	1.13	-	10	183	18181

STANDARD MATERIALS

Zinc Die Cast



Zinc Die Cast

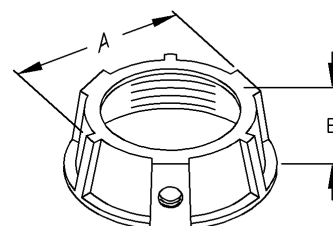

TYPE 806Z

CATALOG NUMBER	TRADE SIZE	DIM A	DIM B	UNIT PACK	MASTER PACK	LBS. / 100 PCS.	UPC #
806Z	1/2"	1.15	0.47	100	1000	3	18062
807Z	3/4"	1.41	0.47	100	1000	4	18072
808Z	1"	1.68	0.54	50	500	7	18082
809Z	1-1/4"	1.94	0.60	25	250	15	18092
810Z	1-1/2"	2.20	0.62	25	250	19	18102
811Z	2"	2.80	0.62	-	25	22	18112
812Z	2-1/2"	3.32	0.93	-	25	42	18122
814Z	3"	3.94	0.93	-	25	51	18142
815Z	3-1/2"	4.45	0.94	-	25	68	18152
816Z	4"	5.00	0.97	-	25	98	18162

MALLEABLE IRON/**HOT DIPPED GALVANIZED** CABLE SUPPORTS-BODY ONLY

FOR THREADED RIGID CONDUIT AND IMC

APPLICATION

For supporting non-armored electrical cables in vertical conduit risers

FEATURES

- Threaded for Rigid Conduit and IMC
- The fastest and easiest type cable support to install
- Equipped with tapered phenolic bushing

STANDARD MATERIAL

Malleable Iron

STANDARD FINISH

Hot Dipped Galvanized



CATALOG NUMBER	TRADE SIZE	DIM A	DIM B	DIM C	UNIT PACK	MASTER PACK	LBS. / 100 PCS.	UPC #
CSB-200	2"	2.375	2.625	2"-8 NPSM	1	10	175	50035
CSB-250	2-1/2"	2.520	3.610	2 1/2"-8 NPSM	1	10	225	50036
CSB-300	3"	2.750	4.290	3"-8 NPSM	1	10	282	50037
CSB-350	3-1/2"	3.100	4.960	3 1/2"-8 NPSM	1	5	335	50038
CSB-400	4"	3.100	5.520	4"-8 NPSM	1	5	470	50049

CONDUIT CAPPED BUSHINGS

FOR THREADED RIGID CONDUIT AND IMC

FEATURES

→ Bushings are supplied with metal cap insert.

STANDARD MATERIALS

Zinc Die Cast

Zinc Die Cast - Metal Capped

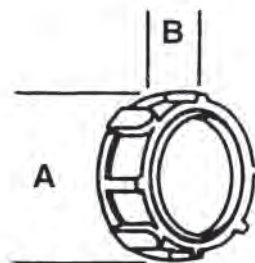

TYPE 820Z

CATALOG NUMBER	TRADE SIZE	DIM A	DIM B	UNIT PACK	MASTER PACK	LBS. / 100 PCS.	UPC #
820Z	1/2"	1.15	0.47	100	1000	2	18202
821Z	3/4"	1.41	0.47	100	1000	4	18212
822Z	1"	1.68	0.54	50	500	6	18222
823Z	1-1/4"	1.94	0.60	25	250	9	18232
824Z	1-1/2"	2.20	0.62	25	250	13	18241
825Z	2"	2.80	0.62	-	25	17	18252
838Z	2-1/2"	3.32	0.93	-	25	35	18382
839Z	3"	3.94	0.93	10	100	48	18392
840Z	3-1/2"	4.45	0.94	5	25	57	18402
841Z	4"	5.00	0.97	5	25	81	18412

Also available Zinc Die Cast bushing with paper cap. Please call factory.

CONDUIT METAL PENNIES

FOR THREADED RIGID CONDUIT AND IMC

APPLICATION

Used to insert into zinc die cast or malleable iron bushing.

STANDARD MATERIALS

Steel

Metal Pennies



TYPE 535M

CATALOG NUMBER	TRADE SIZE	UNIT PACK	MASTER PACK	LBS. / 100 PCS.	UPC #
530M	1/2"	-	500	1	15301
531M	3/4"	-	500	1	15311
532M	1"	-	100	1	15321
533M	1-1/4"	-	100	2	15331
534M	1-1/2"	-	100	2	15341
535M	2"	-	50	3	15351
536M	2-1/2"	-	50	5	15361
537M	3"	-	50	6	15371
538M	3-1/2"	-	25	10	15381
539M	4"	-	25	12	15391
559M	5"	-	10	13	15591
569M	6"	-	10	15	15691

PHENOLIC INSULATING COUPLINGS

FOR THREADED RIGID CONDUIT AND IMC

APPLICATION

The ICC Coupling is recommended for use where high strength or resistance to moisture or acid conditions is required.

FEATURES

- Has a substantial center shoulder, which prevents butting of the conduits, to assure a definite break in the metallic path
- Will not melt, soften or burn
- Temperature rating is 150°C
- Dielectric strength of 220 V/mil.
- Tapered threads (NPT)

STANDARD MATERIALS

Canvas base phenolic (black)

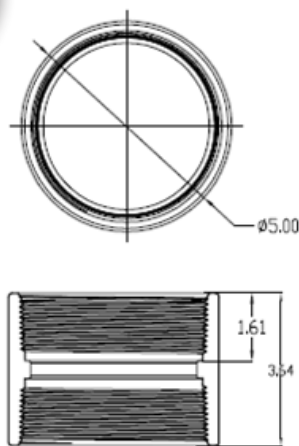

TYPE ICC-400

CATALOG NUMBER	TRADE SIZE	DIM A	DIM B	DIM C	UNIT PACK	MASTER PACK	LBS. / 100 PCS.	UPC #
ICC-400	4"	5.00	1.61	3.34	1	10	66	82345

PLASTIC BUSHINGS

FOR THREADED RIGID CONDUIT AND IMC

APPLICATION

Threaded plastic bushings are used at the end of threaded conduit, or conduit connector, to provide smooth well rounded bearing surface for wires or cables as required by the National Electrical Code.

FEATURES

- Thermoplastic material-heat, impact and torque resistance
- Meets UL and CSA specifications

STANDARD MATERIALS

Flame-Retardant
Polypropylene.
(Rated to 221° F, 105° C)

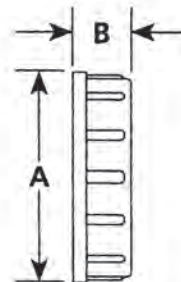

TYPE ST10

CATALOG NUMBER	TRADE SIZE	DIM A	DIM B	UNIT PACK	MASTER PACK	LBS. / 100 PCS.	UPC #
ST10	1/2"	1.03	0.37	100	1000	1	51068
ST11	3/4"	1.28	0.39	100	1000	1	51168
ST12	1"	1.65	0.50	50	500	2	51268
ST13	1-1/4"	2.10	0.49	25	250	2	51368
ST14	1-1/2"	2.28	0.49	25	250	4	51468
ST15	2"	2.66	0.54	-	100	5	51568
ST16	2-1/2"	3.31	0.63	-	25	6	51668
ST17	3"	3.95	0.70	-	25	7	51768
ST18	3-1/2"	4.41	0.71	-	25	8	51868
ST19	4"	4.94	0.73	-	25	9	51968
ST20	5"	6.38	1.00	-	5	32	52068
ST21	6"	7.50	0.99	-	5	40	52168

OFFSET CONDUIT NIPPLES

FOR RIGID CONDUIT AND IMC

APPLICATION

To offset the axis of raceways 3/4 of an inch.

STANDARD MATERIALS

Zinc Die Cast



Zinc Die Cast

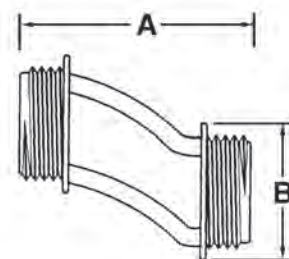

TYPE C41

CATALOG NUMBER	TRADE SIZE	DIM A	DIM B	UNIT PACK	MASTER PACK	LBS. / 100 PCS.	UPC #
C41	1/2"	2.440	0.940	10	100	12	13412
C42	3/4"	2.560	1.150	10	100	16	13422
C43	1"	2.750	1.420	10	100	22	13432
C44	1-1/4"	2.880	1.850	5	50	34	13442
C45	1-1/2"	3.060	2.070	5	50	46	13452
C46	2"	3.120	2.600	2	20	66	13462
C465	2-1/2"	3.500	2.980	-	2	97	13465
C466	3"	3.850	3.360	-	1	184	13475
C467	3-1/2"	5.000	4.477	-	1	200	13485
C468	4"	5.000	4.960	-	1	222	13495

STANDARD MATERIALS

Malleable Iron

MATERIAL/FINISH

Zinc Plated



Malleable Iron

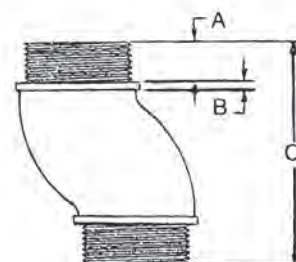

TYPE OSN50

CATALOG NUMBER	TRADE SIZE	DIM A	DIM B	DIM C	UNIT PACK	MASTER PACK	LBS. / 100 PCS.	UPC #
OSN50	1/2"	0.438	0.125	2.250	10	100	22	13991
OSN75	3/4"	0.500	0.125	2.438	10	100	30	13993
OSN100	1"	0.563	0.125	2.500	10	100	42	13995
OSN125	1-1/4"	0.625	0.125	2.625	5	50	70	13997

ZINC CONDUIT NIPPLES

FOR THREADED RIGID CONDUIT AND IMC

APPLICATION

Used through knockout to connect box to conduit coupling. Used with a locknut to connect two boxes side by side or back to back. Used with a locknut to connect fixture housing to continuous runs.

FEATURES

- Available with insulated Throat.
- With rigid conduit threads (NPS)

STANDARD MATERIALS

Zinc Die Cast

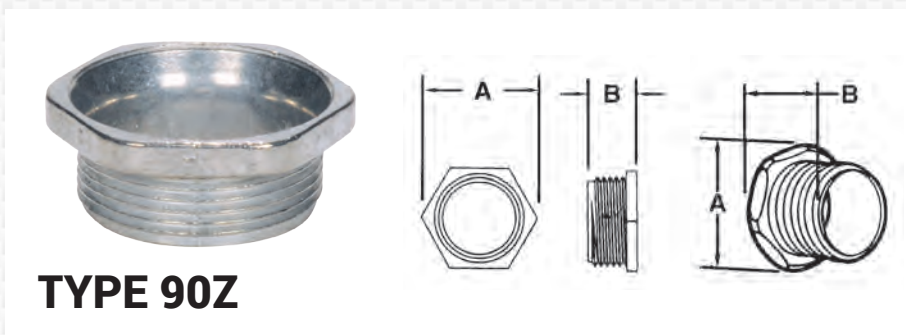

TYPE 90Z

CATALOG NUMBER	TRADE SIZE	DIM A	DIM B	UNIT PACK	MASTER PACK	LBS. / 100 PCS.	UPC #
90Z	1/2"	1.02	0.68	100	1000	4	19002
91Z	3/4"	1.29	0.75	50	500	6	19102
92Z	1"	1.53	0.87	25	250	10	19202
93Z	1-1/4"	1.89	0.94	25	250	14	19302
94Z	1-1/2"	2.30	0.91	25	100	20	19402
95Z	2"	2.88	1.07	10	40	32	19502
96Z	2-1/2"	3.39	1.38	10	40	43	19602
97Z	3"	4.06	1.44	10	40	55	19702
98Z	3-1/2"	4.61	1.47	10	40	68	19802
99Z	4"	5.15	1.47	5	20	70	19902

Insulated Throat

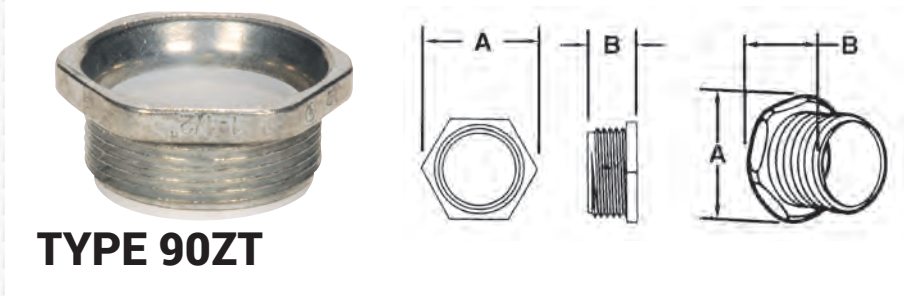

TYPE 90ZT

CATALOG NUMBER	TRADE SIZE	DIM A	DIM B	UNIT PACK	MASTER PACK	LBS. / 100 PCS.	UPC #
90ZT	1/2"	1.02	0.68	100	1000	4	19004
91ZT	3/4"	1.29	0.75	50	500	6	19104
92ZT	1"	1.53	0.87	25	250	10	19204
93ZT	1-1/4"	1.89	0.94	25	250	14	19304
94ZT	1-1/2"	2.30	0.91	25	100	20	19404
95ZT	2"	2.88	1.07	10	40	32	19504
96ZT	2-1/2"	3.39	1.38	10	40	43	19604
97ZT	3"	4.06	1.44	10	40	55	19704
98ZT	3-1/2"	4.61	1.47	10	40	68	19804
99ZT	4"	5.15	1.47	5	20	70	19904

MALLEABLE IRON CONDUIT NIPPLES

FOR THREADED RIGID CONDUIT AND IMC

APPLICATION

Used through knockout to connect box to conduit coupling. Used with a locknut to connect two boxes side by side or back to back. Used with a locknut to connect fixture housing to continuous runs.

FEATURES

- Available with insulated Throat.
- With rigid conduit threads (NPS)

STANDARD MATERIALS

Malleable Iron

STANDARD FINISH

Zinc Plated

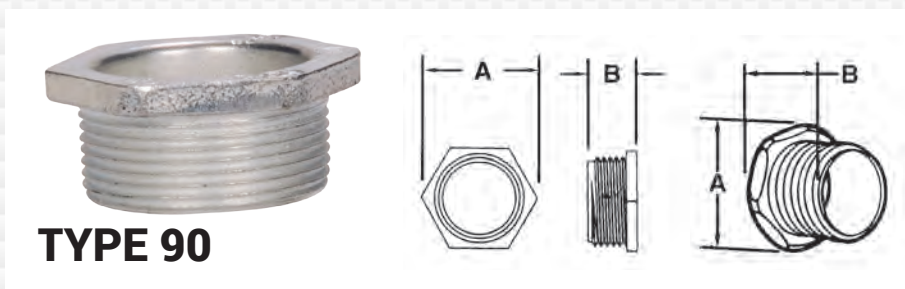

TYPE 90

CATALOG NUMBER	TRADE SIZE	DIM A	DIM B	UNIT PACK	MASTER PACK	LBS. / 100 PCS.	UPC #
90	1/2"	1.050	0.585	100	1000	6	19001
91	3/4"	1.310	0.545	100	1000	8	19101
92	1"	1.640	0.710	50	500	15	19201
93	1-1/4"	2.095	0.840	25	250	24	19301
94	1-1/2"	2.410	0.835	-	25	28	19401
95	2"	2.945	0.900	-	25	38	19501
96	2-1/2"	3.955	1.200	-	15	71	19601
97	3"	4.390	1.490	-	10	124	19701
98	3-1/2"	4.925	1.395	-	10	163	19801
99	4"	5.420	1.395	-	10	199	19901
995	5"	6.950	1.800	-	5	331	19951
996	6"	8.370	2.165	-	5	441	19961

Insulated Throat



TYPE 90T

CATALOG NUMBER	TRADE SIZE	DIM A	DIM B	UNIT PACK	MASTER PACK	LBS. / 100 PCS.	UPC #
90T	1/2"	1.050	0.585	100	1000	6	19003
91T	3/4"	1.310	0.545	100	1000	8	19103
92T	1"	1.640	0.710	50	500	15	19203
93T	1-1/4"	2.095	0.840	25	250	24	19303
94T	1-1/2"	2.410	0.835	-	25	28	19403
95T	2"	2.945	0.900	-	25	38	19503
96T	2-1/2"	3.955	1.200	-	15	72	19603
97T	3"	4.390	1.490	-	10	125	19703
98T	3-1/2"	4.925	1.395	-	10	166	19803
99T	4"	5.420	1.395	-	10	202	19903
995T	5"	6.950	1.800	-	5	336	19953
996T	6"	8.370	2.165	-	5	448	19963

MALLEABLE IRON WATERTIGHT CONDUIT HUBS

FOR THREADED RIGID CONDUIT AND IMC

APPLICATION

General Purpose Fitting.
Insulated Throat form with
Bonding Screw.

FEATURES

- Male thread type
- Tapered female thread for rigid conduit and IMC
- Recessed O-ring seal assures watertight and dust tight connections.
- Insulated throat and bonding locknut is suitable for service entrance application.
- Suitable for use in hazardous locations as follows: Class I, Div. 2 Class II, Div. I, 2 Class III, Div. I, 2 Per NEC 501-4 (b), 502-4 (a), 503-3 (a)

MATERIAL/FINISH

Malleable Iron/Zinc Plated

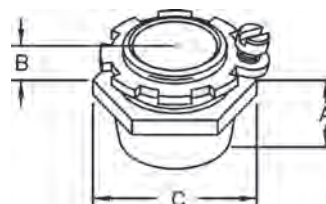

TYPE CHM50

CATALOG NUMBER	TRADE SIZE	DIM A	DIM B	DIM C	UNIT PACK	MASTER PACK	LBS. / 100 PCS.	UPC #
CHM50	1/2"	0.813	0.625	1.500	25	250	18	70870
CHM75	3/4"	0.938	0.625	1.813	25	250	25	70871
CHM100	1"	1.063	0.750	2.063	10	100	39	70872
CHM125	1-1/4"	1.250	0.750	2.625	5	25	54	70873
CHM150	1-1/2"	1.250	0.813	3.125	2	20	64	70874
CHM200	2"	1.250	0.813	3.563	2	20	98	70875
CHM250	2-1/2"	1.625	1.188	4.125	-	10	196	70876
CHM300	3"	1.750	1.250	4.938	-	5	282	70877
CHM350	3-1/2"	1.813	1.313	5.750	-	5	351	70878
CHM400	4"	1.938	1.375	6.188	-	5	395	70879
CHM500	5"	2.063	1.438	7.625	-	1	717	70880
CHM600	6"	2.125	1.563	8.813	-	1	888	70881

MALLEABLE IRON/HOT DIPPED GALVANIZED WATERTIGHT CONDUIT HUBS

FOR THREADED RIGID CONDUIT AND IMC

APPLICATION

General Purpose Fitting.
Insulated Throat form with Bonding Screw.

FEATURES

- Male thread type
- Tapered female thread for rigid conduit and IMC
- Recessed O-ring seal assures watertight and dust tight connections.
- Insulated throat and bonding locknut is suitable for service entrance application.
- Suitable for use in hazardous locations as follows: Class I, Div. 2 Class II, Div. I, 2 Class III, Div. I, 2 Per NEC 501-4 (b), 502-4 (a), 503-3 (a)

MATERIAL/FINISH

Malleable Iron

STANDARD FINISH

Hot Dipped Galvanized/Zinc Plated

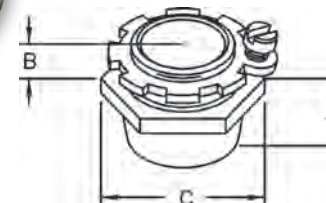

TYPE CHM50G

CATALOG NUMBER	TRADE SIZE	DIM A	DIM B	DIM C	UNIT PACK	MASTER PACK	LBS. / 100 PCS.	UPC #
CHM50G	1/2"	0.813	0.625	1.500	25	250	18	70910
CHM75G	3/4"	0.938	0.625	1.813	25	250	25	70911
CHM100G	1"	1.063	0.750	2.063	10	100	39	70912
CHM125G	1-1/4"	1.250	0.750	2.625	5	25	54	70913
CHM150G	1-1/2"	1.250	0.813	3.125	2	20	64	70914
CHM200G	2"	1.250	0.813	3.563	2	20	98	70915
CHM250G	2-1/2"	1.625	1.188	4.125	-	10	196	70916
CHM300G	3"	1.750	1.250	4.938	-	5	282	70917
CHM350G	3-1/2"	1.813	1.313	5.750	-	5	351	70918
CHM400G	4"	1.938	1.375	6.188	-	5	395	70919

WATERTIGHT CONDUIT HUBS

FOR THREADED RIGID CONDUIT AND IMC

APPLICATION

To secure threaded rigid service entrance conduit to box or enclosure. Insulated throat rated 105° C. BUNA-N sealing ring completely encircles knockout to prevent contaminants from entering enclosure.

FEATURES

- Assembled with 105°C rated flame retardant Lexan throat insulator and BUNA-N sealing ring.
- UL Listed and CSA Certified for use in wet locations.
- Meets NEMA sealing requirements for Type 2, 3, 3R, 4, 4X, 5, 12, and 13 enclosures.
- Certified for use in hazardous locations, Class II, Groups E, F, G and Class III.

STANDARD MATERIALS

Zinc Die Cast



UL LISTED
E198258



CSA CERTIFIED
C5F17

Note:
Minimum wall thickness that can be accommodated is 1/32

Zinc Die Cast



TYPE TWH20

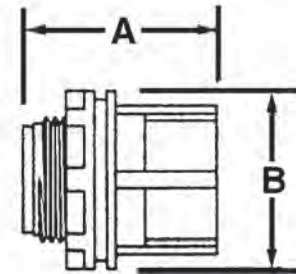

CATALOG NUMBER	TRADE SIZE	DIM A	DIM B	UNIT PACK	MASTER PACK	LBS. / 100 PCS.	UPC #
TWH10	1/2"	1.450	1.210	25	250	16	70010
TWH20	3/4"	1.570	1.430	25	250	22	70020
TWH30	1"	1.865	1.850	10	100	41	70030
TWH40	1-1/4"	1.985	2.280	5	25	55	70040
TWH50	1-1/2"	2.040	2.555	2	20	68	70050
TWH60	2"	2.150	3.060	2	20	95	70060
TWH70	2-1/2"	2.550	3.580	-	10	165	70070
TWH80	3"	2.625	4.190	-	5	216	70080
TWH90	3-1/2"	2.655	4.780	-	5	260	70090
TWH100	4"	2.680	5.355	-	5	338	70100

STANDARD CONDUIT LOCKNUTS

FOR THREADED RIGID CONDUIT AND IMC

APPLICATION

Conduit locknuts for securing threaded conduit or connectors with tapered or straight thread, to a knockout or unthreaded slip hole.

STANDARD MATERIALS

Steel

STANDARD FINISH

Zinc Plated

Standard Locknuts



TYPE 707

CATALOG NUMBER	TRADE SIZE	DIM A	DIM B	UNIT PACK	MASTER PACK	LBS. / 100 PCS.	UPC #
706	1/2"	1.13	0.13	100	3000	1	17061
707	3/4"	1.40	0.13	100	1000	2	17071
708	1"	1.72	0.15	50	500	3	17081
709	1-1/4"	2.08	0.15	100	1000	4	17091
710	1-1/2"	2.40	0.16	100	1000	6	17101
711	2"	2.90	0.17	50	500	8	17111
712	2-1/2"	3.48	0.19	50	250	14	17121
713	3"	4.13	0.18	25	250	18	17131
714	3-1/2"	4.70	0.20	25	125	23	17141
715	4"	5.32	0.20	-	25	26	17151
716	5"	6.38	0.42	-	10	60	17161
717	6"	7.75	0.43	-	10	70	17171

APPLICATION

Sealing locknuts provide a raintight seal when securing threaded conduit or connectors with tapered or straight thread, to a knockout or unthreaded slip hole of a box or enclosure. Installed as per the National Electrical Code Article 345-Intermediate Metal Conduit and Article 346-Rigid Metal Conduit

STANDARD MATERIALS

Steel/Neoprene Gasket

STANDARD FINISH

Zinc Plated

Sealing Locknuts



TYPE 706P

CATALOG NUMBER	TRADE SIZE	DIM A	DIM B	DIM C	UNIT PACK	MASTER PACK	LBS. / 100 PCS.	UPC #
706P	1/2"	0.780	0.970	0.110	100	1000	1	17063
707P	3/4"	1.100	1.210	0.100	100	1000	2	17073
708P	1"	1.270	1.520	0.090	50	500	4	17083
709P	1-1/4"	1.550	1.860	0.110	-	100	6	17093
710P	1-1/2"	1.820	2.100	0.120	-	100	7	17103
711P	2"	2.300	2.610	0.120	-	50	10	17113
712P	2-1/2"	2.820	3.180	0.140	-	20	14	17123
713P	3"	3.450	3.870	0.200	-	10	19	17115
714P	3-1/2"	3.950	4.400	0.200	-	10	23	17116
715P	4"	4.450	4.930	0.210	-	10	27	17117
716P	5"	6.515	6.223	0.975	-	10	90	17118
717P	6"	7.785	7.225	1.100	-	10	100	17119



STANDARD CONDUIT LOCKNUTS

FOR THREADED RIGID CONDUIT AND IMC

APPLICATION

Used with bushings to bond threaded rigid conduit and IMC to boxes, cabinets or other enclosures where locknut is exposed.

STANDARD MATERIALS

Steel

STANDARD FINISH

Zinc Plated



Grounding Locknuts

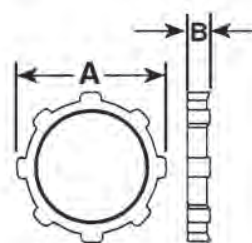

TYPE GL75

CATALOG NUMBER	TRADE SIZE	DIM A	DIM B	UNIT PACK	MASTER PACK	LBS. / 100 PCS.	UPC #
GL70	1/2"	1.250	0.220	100	1000	3	17704
GL71	3/4"	1.450	0.260	100	1000	4	17714
GL72	1"	1.720	0.245	50	500	5	17724
GL73	1-1/4"	2.020	0.240	50	500	6	17734
GL74	1-1/2"	2.535	0.250	50	500	8	17744
GL75	2"	2.950	0.250	25	250	13	17754
GL76	2-1/2"	3.570	0.280	10	100	19	17764
GL77	3"	4.330	0.295	10	100	21	17774
GL78	3-1/2"	4.810	0.310	10	100	38	17784
GL79	4"	5.395	0.300	10	100	40	17794
GL80	5"	6.487	0.525	-	10	76	17804
GL81	6"	7.830	0.525	-	10	87	17814

APPLICATION

Used with a fixture nipple to hang fixtures.

STANDARD MATERIALS

Steel

STANDARD FINISH

Zinc Plated

Conduit Oversize Locknuts



TYPE 705X

CATALOG NUMBER	TRADE SIZE	DIM ACROSS CORNERS	DIM ACROSS FLATS	UNIT PACK	MASTER PACK	LBS. / 100 PCS.	UPC #
705X	3/8"	1.038	1.006	-	250	1	17052

MALLEABLE IRON 3-PIECE COUPLINGS

FOR THREADED RIGID CONDUIT AND IMC

APPLICATION

Used to join two lengths of threaded conduit.

FEATURES

- Threaded (NPS) for rigid conduit and IMC
- Concrete tight

STANDARD MATERIALS

Malleable Iron

STANDARD FINISH

Zinc Plated



TYPE 1023

CATALOG NUMBER	TRADE SIZE	DIM A	DIM B	DIM C	UNIT PACK	MASTER PACK	LBS. / 100 PCS.	UPC #
1022	1/2"	1.38	1.36	1.36	20	200	26	10221
1023	3/4"	1.63	1.58	1.58	10	100	37	10231
1024	1"	1.81	1.89	1.89	-	20	55	10241
1025	1-1/4"	2.19	2.38	2.38	-	20	111	10251
1026	1-1/2"	2.31	2.83	2.83	-	10	172	10261
1027	2"	2.44	3.29	3.29	-	10	203	10271
1028	2-1/2"	3.19	4.08	4.08	2	10	327	10281
1029	3"	3.31	4.67	4.67	2	10	442	10291
1030	3-1/2"	3.50	5.07	5.07	1	5	608	10301
1031	4"	3.75	5.75	5.75	1	5	718	10311
1005	5"	3.69	6.88	7.50	-	1	1050	10051
1006	6"	4.31	8.00	8.00	-	1	1250	10061

MALLEABLE IRON/HOT DIPPED GALVANIZED 3-PIECE COUPLINGS

FOR THREADED RIGID CONDUIT AND IMC



APPLICATION

Used to join two lengths of threaded conduit.

FEATURES

- Threaded (NPS) for rigid conduit and IMC
- Concrete tight

STANDARD MATERIALS

Malleable Iron

STANDARD FINISH

Hot Dipped Galvanized/Zinc Plated



TYPE 1023G

CATALOG NUMBER	TRADE SIZE	DIM A	DIM B	DIM C	UNIT PACK	MASTER PACK	LBS. / 100 PCS.	UPC #
1022G	1/2"	1.38	1.36	1.36	20	200	26	10009
1023G	3/4"	1.63	1.58	1.58	10	100	37	10210
1024G	1"	1.81	1.89	1.89	-	20	55	10011
1025G	1-1/4"	2.19	2.38	2.38	-	20	111	10012
1026G	1-1/2"	2.31	2.83	2.83	-	10	172	10013
1027G	2"	2.44	3.29	3.29	-	10	203	10014
1028G	2-1/2"	3.19	4.08	4.08	2	10	327	10015
1029G	3"	3.31	4.67	4.67	2	10	442	10016
1030G	3-1/2"	3.50	5.07	5.07	1	5	608	10017
1031G	4"	3.75	5.75	5.75	1	5	718	10018
1005G	5"	3.69	6.88	7.50	-	1	1050	10019
1006G	6"	4.31	8.00	8.00	-	1	1250	10020

MALLEABLE IRON RIGID COMPRESSION CONNECTORS

FOR THREADLESS RIGID CONDUIT AND IMC

APPLICATION

To connect threadless rigid conduit to boxes and enclosures.

FEATURES

- Concrete tight Male Hub Threads
- NPSM Thread 1/2" through 2"
- NPT Thread above 2"

STANDARD MATERIALS

Malleable Iron

STANDARD FINISH

Zinc Plated



TYPE NTC-50

CATALOG NUMBER	TRADE SIZE	DIM A	DIM B	DIM C	UNIT PACK	MASTER PACK	LBS. / 100 PCS.	UPC #
NTC-50	1/2"	1.500	0.500	1.500	25	250	20	14213
NTC-75	3/4"	1.500	0.500	1.625	25	250	22	14223
NTC-100	1"	1.688	0.563	2.000	10	100	34	14233
NTC-125	1-1/4"	2.000	0.688	2.375	5	50	52	14243
NTC-150	1-1/2"	2.063	0.688	2.625	2	20	65	14253
NTC-200	2"	2.250	0.875	3.313	5	25	107	14263
NTC-250	2-1/2"	2.936	1.250	3.750	1	10	243	14273
NTC-300	3"	3.125	1.375	4.250	1	5	295	14283
NTC-350	3-1/2"	3.125	1.375	4.750	1	5	383	14293
NTC-400	4"	3.375	1.500	5.313	1	5	467	14294
NTC-500	5"	4.250	1.818	6.016	-	1	760	14295
NTC-600	6"	4.563	2.000	7.625	-	1	1100	14296

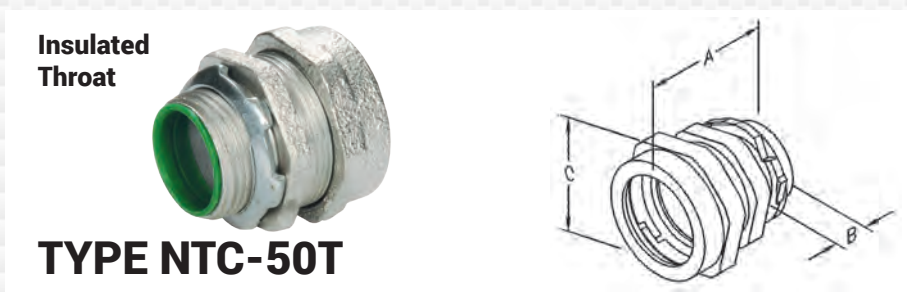

TYPE NTC-50T

CATALOG NUMBER	TRADE SIZE	DIM A	DIM B	DIM C	UNIT PACK	MASTER PACK	LBS. / 100 PCS.	UPC #
NTC-50T	1/2"	1.563	0.563	1.500	25	250	21	14214
NTC-75T	3/4"	1.563	0.563	1.625	25	250	23	14224
NTC-100T	1"	1.750	0.625	2.000	10	100	34	14234
NTC-125T	1-1/4"	2.000	0.688	2.375	5	50	53	14244
NTC-150T	1-1/2"	2.125	0.750	2.625	2	20	66	14254
NTC-200T	2"	2.313	0.813	3.313	5	25	114	14264
NTC-250T	2-1/2"	3.000	1.313	3.750	1	10	245	14265
NTC-300T	3"	3.125	1.438	4.250	1	5	298	14266
NTC-350T	3-1/2"	3.188	1.500	4.750	1	5	387	14267
NTC-400T	4"	3.438	1.563	5.313	1	5	472	14268
NTC-500T	5"	4.283	1.965	6.016	-	1	787	14269
NTC-600T	6"	4.613	2.125	7.625	-	1	1110	14270

MALLEABLE IRON RIGID COMPRESSION COUPLINGS

FOR THREADLESS RIGID CONDUIT AND IMC

APPLICATION

To couple sections of threadless rigid conduit together

FEATURES

→ Concrete tight

STANDARD MATERIALS

Malleable Iron

STANDARD FINISH

Zinc Plated



TYPE NTCC-50

CATALOG NUMBER	TRADE SIZE	DIM A	DIM B	DIM C	UNIT PACK	MASTER PACK	LBS. / 100 PCS.	UPC #
NTCC-50	1/2"	1.813	0.500	1.500	25	250	30	14413
NTCC-75	3/4"	1.875	0.500	1.625	10	100	32	14414
NTCC-100	1"	2.188	0.563	2.000	5	50	44	14415
NTCC-125	1-1/4"	2.625	0.688	2.375	5	50	78	14416
NTCC-150	1-1/2"	2.688	0.750	2.625	2	20	93	14417
NTCC-200	2"	3.063	0.938	3.313	5	25	159	14418
NTCC-250	2-1/2"	4.500	2.000	3.750	1	10	277	14473
NTCC-300	3"	4.938	2.250	4.250	1	5	393	14483
NTCC-350	3-1/2"	5.000	2.250	4.750	1	5	547	14493
NTCC-400	4"	5.625	2.438	5.313	1	5	626	14494
NTCC-500	5"	6.250	2.713	6.016	-	1	1220	14423
NTCC-600	6"	6.875	2.975	7.625	-	1	1300	14424

MALLEABLE IRON RIGID SET-SCREW CONNECTORS

FOR THREADLESS RIGID CONDUIT AND IMC

APPLICATION

To connect threadless rigid conduit to boxes and enclosures.

FEATURES

- Concrete tight
- Available with insulated throat
- Male hub thread (NPS)

STANDARD MATERIALS

Malleable Iron

STANDARD FINISH

Zinc Plated



TYPE TRC-50

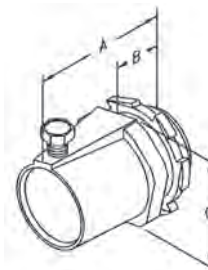

CATALOG NUMBER	TRADE SIZE	DIM A	DIM B	DIM C	UNIT PACK	MASTER PACK	LBS. / 100 PCS.	UPC #
TRC-50	1/2"	1.375	0.438	1.313	25	250	13	70830
TRC-75	3/4"	1.688	0.500	1.563	25	100	21	70831
TRC-100	1"	1.938	0.563	1.875	5	25	38	70832
TRC-125	1-1/4"	2.188	0.625	2.188	5	25	44	70833
TRC-150	1-1/2"	2.313	0.625	2.500	5	20	67	70834
TRC-200	2"	2.438	0.625	2.938	2	10	105	70835
TRC-250	2-1/2"	3.188	0.750	3.625	2	10	190	70836
TRC-300	3"	3.813	0.875	4.250	1	5	272	70837
TRC-350	3-1/2"	4.313	0.938	4.688	1	5	367	70838
TRC-400	4"	4.625	0.938	5.188	1	5	427	70839
TRC-500	5"	4.750	1.375	6.500	-	1	695	70890
TRC-600	6"	4.938	1.500	7.500	-	1	911	70900

Insulated Throat



TYPE TRC-50T

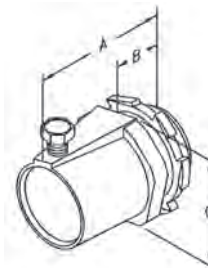

CATALOG NUMBER	TRADE SIZE	DIM A	DIM B	DIM C	UNIT PACK	MASTER PACK	LBS. / 100 PCS.	UPC #
TRC-50T	1/2"	1.375	0.500	1.313	25	250	14	70840
TRC-75T	3/4"	1.688	0.563	1.563	25	100	22	70841
TRC-100T	1"	1.938	0.625	1.875	5	25	39	70842
TRC-125T	1-1/4"	2.188	0.688	2.188	5	25	54	70843
TRC-150T	1-1/2"	2.313	0.688	2.500	5	20	70	70844
TRC-200T	2"	2.438	0.688	2.938	2	10	106	70845
TRC-250T	2-1/2"	3.188	0.813	3.625	2	10	191	70846
TRC-300T	3"	3.813	0.938	4.250	1	5	280	70847
TRC-350T	3-1/2"	4.313	1.000	4.688	1	5	380	70848
TRC-400T	4"	4.500	1.000	5.188	1	5	455	70849
TRC-500T	5"	4.688	1.438	6.500	-	1	701	70170
TRC-600T	6"	4.938	1.563	7.500	-	1	920	70180

MALLEABLE IRON RIGID SET-SCREW COUPLINGS

FOR THREADLESS RIGID CONDUIT AND IMC

APPLICATION

To couple sections of threadless rigid conduit together

FEATURES

→ Concrete tight

STANDARD MATERIALS

Malleable Iron

STANDARD FINISH

Zinc Plated



TYPE TRCC-75

CATALOG NUMBER	TRADE SIZE	DIM A	DIM B	DIM C	UNIT PACK	MASTER PACK	LBS. / 100 PCS.	UPC #
TRCC-50	1/2"	1.750	0.750	1.375	20	100	30	70820
TRCC-75	3/4"	2.000	0.875	1.563	20	100	32	70821
TRCC-100	1"	2.688	1.188	1.875	5	50	44	70822
TRCC-125	1-1/4"	2.750	1.250	2.188	5	25	78	70823
TRCC-150	1-1/2"	3.188	1.500	2.500	5	20	93	70824
TRCC-200	2"	3.375	1.563	3.000	2	10	159	70825
TRCC-250	2-1/2"	4.000	1.718	3.125	2	10	277	70826
TRCC-300	3"	4.250	1.938	3.750	1	5	393	70827
TRCC-350	3-1/2"	4.500	2.250	4.250	1	5	547	70828
TRCC-400	4"	4.750	2.625	4.750	1	5	626	70829
TRCC-500	5"	6.000	2.818	6.500	-	1	1220	70862
TRCC-600	6"	6.500	3.000	7.500	-	1	1300	70863

COMBINATION COUPLINGS

FOR RIGID CONDUIT, IMC AND E.M.T.

APPLICATION

To join E.M.T. to Rigid or IMC

FEATURES

- Threaded rigid and IMC to compression E.M.T.
- Concrete tight
- NPT female hub

STANDARD MATERIALS

Steel

STANDARD FINISH

Zinc Plated



For EMT Steel Compression to Threaded Rigid Couplings

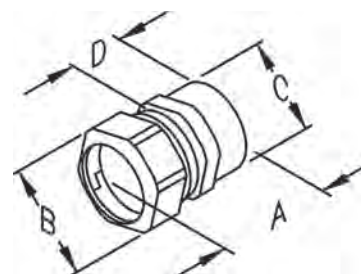

TYPE ERC-23

CATALOG NUMBER	TRADE SIZE	DIM A	DIM B	DIM C	DIM D	UNIT PACK	MASTER PACK	LBS. / 100 PCS.	UPC #
ERC-22	1/2"	1.313	1.125	0.875	0.688	25	250	14	47322
ERC-23	3/4"	1.438	1.375	1.125	0.750	25	250	25	47323
ERC-24	1"	1.500	1.688	1.375	0.813	25	250	34	47324

APPLICATION

A combination coupling to provide a transition from EMT to unthreaded rigid conduit or IMC.

FEATURES

- Pre-set and staked Robertson head screws
- Concrete tight when taped

STANDARD MATERIALS

Steel

STANDARD FINISH

Zinc Plated



For EMT Steel Set-Screw to Rigid Set-Screw Couplings

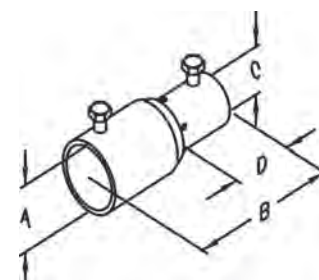

TYPE S18ES

CATALOG NUMBER	TRADE SIZE	DIM A	DIM B	DIM C	DIM D	UNIT PACK	MASTER PACK	LBS. / 100 PCS.	UPC #
S16ES	1/2"	1.000	2.375	0.875	0.938	50	500	14	23016
S17ES	3/4"	1.250	2.813	1.125	1.125	25	250	28	23017
S18ES	1"	1.500	3.000	1.188	1.188	-	25	36	23018

COMBINATION COUPLINGS

FOR FLEX METAL CONDUIT TO RIGID OR IMC CONDUIT

APPLICATION

To connect Flexible metal conduit to Rigid or IMC conduit.

FEATURES

- Rigid Conduit to Flex
- Female hub threads - NPT

STANDARD MATERIALS

Malleable Iron

STANDARD FINISH

Zinc Plated



Combination Couplings

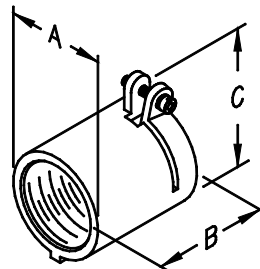

TYPE 22E

CATALOG NUMBER	TRADE SIZE	DIM A	DIM B	DIM C	UNIT PACK	MASTER PACK	LBS. / 100 PCS.	UPC #
22E	1/2"	1.19	1.50	1.69	25	250	14	55221
23E	3/4"	1.38	1.75	1.88	20	200	19	55231
24E	1"	1.63	1.81	2.31	20	100	32	55241
25E	1-1/4"	2.00	2.31	2.62	-	20	36	55251

APPLICATION

Used as a raceway between two enclosures.

STANDARD MATERIALS

Zinc Die Cast



Box Spacers

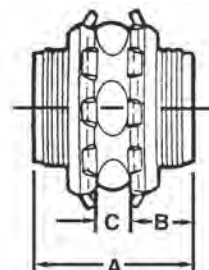

TYPE BS50

CATALOG NUMBER	TRADE SIZE	DIM A	DIM B	DIM C	UNIT PACK	MASTER PACK	LBS. / 100 PCS.	UPC #
BS50	1/2"	1.12	0.40	0.31	50	500	8	70504
BS75	3/4"	1.12	0.40	0.31	50	500	11	70354

MALLEABLE IRON 90° PULL ELBOWS

FOR THREADED RIGID CONDUIT AND IMC

APPLICATION

For connecting rigid conduit or IMC to rigid conduit or IMC to form 90° bend.

FEATURES

- Raintight
- Furnished with Neoprene gasketed steel cover
- Threaded for rigid conduit and IMC (Female-NPT)

STANDARD MATERIALS

Malleable Iron

STANDARD FINISH

Zinc Plated



Female to Female

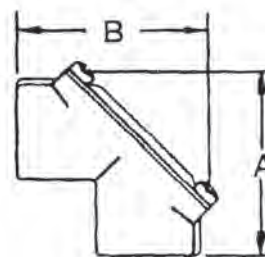

TYPE PEF75

CATALOG NUMBER	TRADE SIZE	DIM A	DIM B	UNIT PACK	MASTER PACK	LBS. / 100 PCS.	UPC #
PEF50	1/2"	2.188	2.188	10	100	36	13701
PEF75	3/4"	2.313	2.313	5	50	49	13703
PEF100	1"	3.125	3.125	-	25	94	13704
PEF125	1-1/4"	3.625	3.625	-	20	140	13705
PEF150	1-1/2"	4.125	4.125	-	10	200	13707
PEF200	2"	4.500	4.500	-	5	345	13708

APPLICATION

For connecting rigid conduit or IMC to box or enclosures to form 90° bend.

FEATURES

- Raintight
- Furnished with Neoprene gasketed steel cover
- Furnished with steel locknut
- Threaded for rigid conduit and IMC (Female-NPT, Male-NPSM)

STANDARD MATERIALS

Malleable Iron

STANDARD FINISH

Zinc Plated



Male to Female

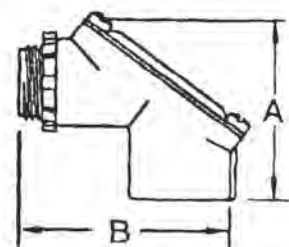

TYPE PEM75

CATALOG NUMBER	TRADE SIZE	DIM A	DIM B	DIM C	UNIT PACK	MASTER PACK	LBS. / 100 PCS.	UPC #
PEM50	1/2"	2.188	2.438	0.563	10	100	36	70887
PEM75	3/4"	2.313	2.625	0.625	5	50	49	70888
PEM100	1"	3.125	3.188	0.625	-	25	94	70882
PEM125	1-1/4"	3.625	4.125	0.750	-	20	140	70883
PEM150	1-1/2"	4.125	5.188	0.813	-	10	200	90142
PEM200	2"	4.500	5.688	0.875	-	5	345	90143

ZINC 90° PULL ELBOWS

FOR THREADED RIGID CONDUIT AND IMC

APPLICATION

For connecting rigid conduit or IMC to rigid conduit or IMC to form 90° bend.

FEATURES

- Raintight
- Furnished with neoprene gasket

STANDARD MATERIALS

Zinc Die Cast



Female to Female

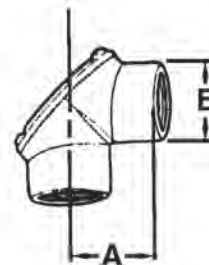

TYPE 1313

CATALOG NUMBER	TRADE SIZE	DIM A	DIM B	UNIT PACK	MASTER PACK	LBS. / 100 PCS.	UPC #
1313	1/2"	1.31	1.09	10	100	28	13132
1314	3/4"	1.43	1.29	5	50	33	13142
1315	1"	1.95	1.59	-	25	62	13152
1316	1-1/4"	2.26	1.97	-	20	91	13162

APPLICATION

For connecting rigid conduit or IMC to box or enclosures to form 90° bend.

FEATURES

- Removable aluminum cover and neoprene gasket facilitate wire pulling
- Assembled with Zinc Die Cast Locknut

STANDARD MATERIALS

Zinc Die Cast



Male to Female

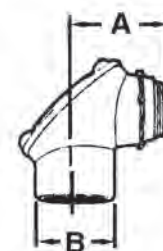

TYPE 1320

CATALOG NUMBER	TRADE SIZE	DIM A	DIM B	UNIT PACK	MASTER PACK	LBS. / 100 PCS.	UPC #
1320	1/2"	1.31	1.09	10	100	36	13202
1321	3/4"	1.47	1.29	5	50	49	13212

MALLEABLE IRON SPLIT COUPLINGS

FOR THREADED RIGID CONDUIT AND IMC

APPLICATION

A speed union for economically joining two threaded rigid metal conduits.

FEATURES

- A neoprene gasket provides a concrete tight seal at the joint
- Used where conduit runs are closely spaced
- Used where conduit is tight against wall, ceiling or other obstruction
- Used where conduit cannot be turned

STANDARD MATERIALS

Malleable Iron

STANDARD FINISH

Zinc Plated



TYPE SCC-200

CATALOG NUMBER	TRADE SIZE	DIM A	DIM B	DIM C	UNIT PACK	MASTER PACK	LBS. / 100 PCS.	UPC #
*SCC-50	1/2"	2.000	1.250	1.250	10	100	34	70795
*SCC-75	3/4"	2.313	1.250	1.500	10	100	40	70796
*SCC-100	1"	2.625	1.625	1.813	10	40	60	70797
*SCC-125	1-1/4"	3.063	1.625	2.188	5	20	75	70798
*SCC-150	1-1/2"	3.313	1.938	2.438	5	20	113	70799
SCC-200	2"	3.813	2.000	2.875	5	20	113	70800
SCC-250	2-1/2"	4.625	3.063	3.563	2	20	275	70801
SCC-300	3"	5.313	3.125	4.125	2	20	300	70802
SCC-350	3-1/2"	6.063	3.250	4.813	1	5	425	70803
SCC-400	4"	6.563	3.438	5.375	1	5	500	70804
SCC-500	5"	8.063	3.875	6.563	-	1	900	70805
SCC-600	6"	9.250	4.188	7.625	-	1	1300	70806

1/2" and 3/4" furnished with one screw
1" through 6" furnished with two screws

MALLEABLE IRON ONE-HOLE STRAPS

FOR THREADED RIGID CONDUIT AND IMC

APPLICATION

Click-on type one-hole straps for rigid conduit or IMC. Provides support for the conduits, as required by the National Electrical Code.

FEATURES

→ Heavy Duty Casting

STANDARD MATERIALS

Malleable Iron

STANDARD FINISH

Zinc Plated



OPTIONAL FINISH

For additional corrosion protection, specify Hot Dipped Galvanized. Add suffix 'G' to Malleable Iron catalog number. Example 133G. For more information, see page 22.



TYPE 133

CATALOG NUMBER	TRADE SIZE	DIM A	DIM B	DIM C	UNIT PACK	MASTER PACK	LBS. / 100 PCS.	UPC #
132	1/2"	1.437	0.625	0.312	100	1000	6	81321
133	3/4"	1.750	0.750	0.312	100	1000	8	81331
134	1"	2.125	0.937	0.312	50	500	9	81341
135	1-1/4"	2.375	1.062	0.437	-	100	22	81351
136	1-1/2"	2.750	1.062	0.500	-	50	32	81361
137	2"	3.937	1.250	0.562	-	50	44	81371
138	2-1/2"	3.937	1.250	0.562	-	25	66	81381
139	3"	5.187	1.750	0.562	-	10	159	81391
141	3-1/2"	5.562	2.125	0.750	-	10	185	81411
148	4"	6.500	2.250	0.750	-	10	221	81481
150	5"	10.040	2.750	0.750	-	5	369	81501
152	6"	12.500	3.130	0.750	-	5	631	81521

MALLEABLE IRON CLAMP BACK SPACERS

FOR THREADED RIGID CONDUIT AND IMC

APPLICATION

Provides space between conduit and mounting surface, for use with malleable iron or aluminum straps.

FEATURES

→ Heavy Duty Casting
→ Can be used with one hole straps.

STANDARD MATERIALS

Malleable Iron

STANDARD FINISH

Zinc Plated



OPTIONAL FINISH

For additional corrosion protection, specify Hot Dipped Galvanized. Add suffix 'G' to Malleable Iron catalog number. Example 901G. For more information, see page 22.



TYPE 901

CATALOG NUMBER	TRADE SIZE	DIM A	DIM B	DIM C	DIM D	UNIT PACK	MASTER PACK	LBS. / 100 PCS.	UPC #
900	1/2"	2.000	1.000	0.500	0.313	100	1000	8	89009
901	3/4"	2.300	1.060	0.500	0.313	100	500	12	89011
902	1"	2.320	1.250	0.560	0.375	50	500	16	89021
903	1-1/4"	3.430	1.870	0.750	0.438	50	250	22	89031
904	1-1/2"	3.810	1.870	0.810	0.438	-	25	35	89041
905	2"	4.750	1.920	1.000	0.563	-	25	51	89051
906	2-1/2"	5.750	2.410	1.000	0.563	-	25	81	89061
907	3"	6.780	2.620	1.000	0.563	-	25	83	89071
908	3-1/2"	7.120	2.870	1.060	0.750	-	20	148	89081
909	4"	8.830	3.060	1.060	0.750	-	10	199	89091
910	5"	10.125	3.750	1.188	0.750	-	10	344	89092
911	6"	12.188	4.000	1.500	0.750	-	10	419	89093

MALLEABLE IRON/**HOT DIPPED GALVANIZED** ONE-HOLE STRAPS

FOR THREADED RIGID CONDUIT AND IMC

APPLICATION

Click-on type one-hole straps for rigid conduit or IMC. Provides support for the conduits, as required by the National Electrical Code.

FEATURES

→ Heavy Duty Casting

STANDARD MATERIALS

Malleable Iron

STANDARD FINISH

Hot Dipped Galvanized/Zinc Plated

OPTIONAL FINISH

For Malleable Iron / Zinc Plated, please remove suffix 'G' from Hot Dipped Galvanized Catalog Number and see page 86.



TYPE 133G

New Product

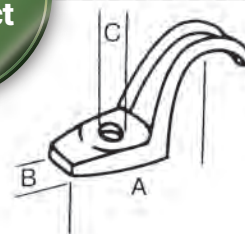

CATALOG NUMBER	TRADE SIZE	DIM A	DIM B	DIM C	UNIT PACK	MASTER PACK	LBS. / 100 PCS.	UPC #
132G	1/2"	1.437	0.625	0.312	100	1000	6	70200
133G	3/4"	1.750	0.750	0.312	100	1000	8	70201
134G	1"	2.125	0.937	0.312	50	500	9	70202
135G	1-1/4"	2.375	1.062	0.437	-	100	22	70203
136G	1-1/2"	2.750	1.062	0.500	-	50	32	70204
137G	2"	3.937	1.250	0.562	-	50	44	70205
138G	2-1/2"	3.937	1.250	0.562	-	25	66	70206
139G	3"	5.187	1.750	0.562	-	10	159	70207
141G	3-1/2"	5.562	2.125	0.750	-	10	185	70208
148G	4"	6.500	2.250	0.750	-	10	221	70209
150G	5"	10.040	2.750	0.750	-	5	369	70210
152G	6"	12.500	3.130	0.750	-	5	631	70211

MALLEABLE IRON/**HOT DIPPED GALVANIZED** CLAMP BACK SPACERS

FOR THREADED RIGID CONDUIT AND IMC

APPLICATION

Provides space between conduit and mounting surface, for use with malleable iron or aluminum straps.

FEATURES

→ Heavy Duty Casting
→ Can be used with one hole straps.

STANDARD MATERIALS

Malleable Iron

STANDARD FINISH

Hot Dipped Galvanized/Zinc Plated

OPTIONAL FINISH

For Malleable Iron / Zinc Plated, please remove suffix 'G' from Hot Dipped Galvanized Catalog Number and see page 86.



TYPE 901G

New Product

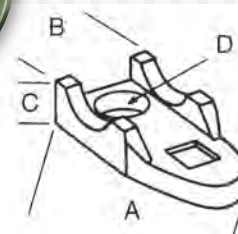

CATALOG NUMBER	TRADE SIZE	DIM A	DIM B	DIM C	DIM D	UNIT PACK	MASTER PACK	LBS. / 100 PCS.	UPC #
900G	1/2"	2.000	1.000	0.500	0.313	100	1000	8	70212
901G	3/4"	2.300	1.060	0.500	0.313	100	500	12	70213
902G	1"	2.320	1.250	0.560	0.375	50	500	16	70214
903G	1-1/4"	3.430	1.870	0.750	0.438	50	250	22	70215
904G	1-1/2"	3.810	1.870	0.810	0.438	-	25	35	70216
905G	2"	4.750	1.920	1.000	0.563	-	25	51	70217
906G	2-1/2"	5.750	2.410	1.000	0.563	-	25	81	70218
907G	3"	6.780	2.620	1.000	0.563	-	25	83	70219
908G	3-1/2"	7.120	2.870	1.060	0.750	-	20	148	70220
909G	4"	8.830	3.060	1.060	0.750	-	10	199	70221
910G	5"	10.125	3.750	1.188	0.750	-	10	344	70222
911G	6"	12.188	4.000	1.500	0.750	-	10	419	70223

STEEL ONE-HOLE STRAPS AND STEEL TWO-HOLE STRAPS

FOR THREADED RIGID CONDUIT AND IMC

APPLICATION

Click-on type one-hole straps for rigid conduit or IMC. Provides support for the conduits, as required by the National Electrical Code.

STANDARD MATERIALS

Steel

STANDARD FINISH

Zinc Plated



TYPE 133S

CATALOG NUMBER	TRADE SIZE	DIM A	DIM B	DIM C	DIM D	DIM E	DIM F	DIM G	UNIT PACK	MASTER PACK	LBS. / 100 PCS.	UPC #
130S	1/4"	0.265	0.235	0.060	0.800	1.125	0.562	0.200	100	1000	2	81307
131S	3/8"	0.340	0.300	0.075	0.937	1.250	0.562	0.250	100	1000	3	81317
132S	1/2"	0.420	0.390	0.075	0.937	1.375	0.625	0.250	100	1000	3	81327
133S	3/4"	0.525	0.500	0.090	1.031	1.562	0.750	0.250	100	1000	3	81337
134S	1"	0.655	0.620	0.090	1.250	1.812	0.875	0.312	50	500	5	81347
135S	1-1/4"	0.830	0.800	0.100	1.500	2.000	0.875	0.375	50	500	7	81357
136S	1-1/2"	0.950	0.920	0.125	1.875	2.500	1.000	0.437	50	250	10	81367
137S	2"	1.185	1.150	0.125	2.125	2.750	1.125	0.562	-	50	17	81377
138S	2-1/2"	1.437	1.400	0.150	2.562	3.312	1.250	0.562	-	25	29	81387
139S	3"	1.750	1.700	0.150	2.875	3.625	1.250	0.562	-	25	50	81397
141S	3-1/2"	2.000	1.950	0.180	3.250	4.000	1.250	0.562	-	15	110	81471
148S	4"	2.250	2.200	0.180	3.500	4.250	1.250	0.562	-	10	120	81417

APPLICATION

Snap-on type two-hole straps for rigid conduit and IMC are used where higher load bearing supports are desired.

STANDARD MATERIALS

Steel

STANDARD FINISH

Zinc Plated



TYPE 2133S

CATALOG NUMBER	TRADE SIZE	DIM A	DIM B	DIM C	DIM D	DIM E	DIM F	DIM G	UNIT PACK	MASTER PACK	LBS. / 100 PCS.	UPC #
2132S	1/2"	0.420	0.390	0.035	1.875	2.500	0.625	0.188	-	250	2	21327
2133S	3/4"	0.525	0.500	0.035	2.250	2.875	0.688	0.188	-	150	2	21337
2134S	1"	0.655	0.620	0.048	2.625	3.375	0.750	0.250	-	100	3	21347
2135S	1-1/4"	0.830	0.800	0.048	3.437	4.188	0.875	0.250	-	50	5	21357
2136S	1-1/2"	0.950	0.920	0.060	3.812	4.625	0.937	0.250	-	50	7	21367
2137S	2"	1.185	1.150	0.060	4.250	5.125	1.000	0.375	-	25	12	21377
2138S	2-1/2"	1.437	1.400	0.075	4.875	5.875	1.000	0.375	-	25	20	21387
2139S	3"	1.750	1.700	0.075	5.500	6.500	1.000	0.375	-	20	28	21397
2141S	3-1/2"	2.000	1.950	0.090	6.375	7.375	1.000	0.437	-	15	31	21417
2148S	4"	2.250	2.200	0.090	7.000	8.000	1.000	0.437	-	10	36	21487
2150S	5"	2.560	2.560	0.125	8.250	9.000	1.000	0.437	-	10	49	21507
2152S	6"	3.125	3.125	0.125	8.500	9.250	1.000	0.437	-	10	55	21527

CONDUIT REDUCER BUSHINGS

FOR THREADED RIGID CONDUIT AND IMC

APPLICATION

To reduce the trade size of a tapered entry on a conduit fitting.

FEATURES

- Threaded for rigid conduit and IMC.
- Made with rolled edge, protects wire insulation.

STANDARD MATERIALS

Steel

STANDARD FINISH

Zinc Plated



Flush Type

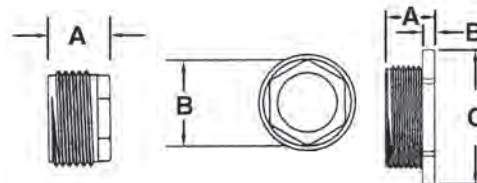

TYPE CR1

CATALOG NUMBER	TRADE SIZE	DIM A	DIM B	DIM C	UNIT PACK	MASTER PACK	LBS. / 100 PCS.	UPC #
CR0	1/2" x 3/8"	0.638	0.908		-	200	3	80007
CR1	3/4" x 1/2"	0.650	0.930		-	200	4	80017
CR2	1" x 1/2"	0.715	1.125		-	100	13	80027
CR3	1" x 3/4"	0.715	1.125		-	100	8	80037
CR4	1-1/4" x 1/2"	0.820	1.470		-	50	29	80047
CR5	1-1/4" x 3/4"	0.820	1.470		-	50	22	80057
CR6	1-1/4" x 1"	0.810	1.470		-	50	14	80067
CR7	1-1/2" x 1/2"	0.850	1.700		-	50	38	80077
CR8	1-1/2" x 3/4"	0.850	1.700		-	50	32	80087
CR9	1-1/2" x 1"	0.850	1.700		-	50	24	80097
CR10	1-1/2" x 1-1/4"	0.850	1.700		-	50	12	80107
CR11	2" x 1/2"	0.970	2.230		-	25	45	80117
CR12	2" x 3/4"	0.970	2.230		-	25	68	80127
CR13	2" x 1"	0.970	2.230		-	25	54	80137
CR14	2" x 1-1/4"	0.970	2.230		-	25	44	80147
CR15	2" x 1-1/2"	0.970	2.230		-	25	31	80157
CR18	2-1/2" x 1"	1.070	0.580	1.950	-	10	88	80187
CR19	2-1/2" x 1-1/4"	1.070	0.670	2.390	-	10	91	80197
CR20	2-1/2" x 1-1/2"	1.070	0.700	2.680	-	10	80	80207
CR21	2-1/2" x 2"	1.200	0.750	3.485	-	10	50	80217
CR24	3" x 1"	1.785	0.500	4.075	-	10	116	80247
CR25	3" x 1-1/4"	2.100	0.410	3.445	-	10	126	80257
CR26	3" x 1-1/2"	2.020	0.440	3.460	-	10	117	80267
CR27	3" x 2"	2.000	0.400	3.380	-	10	121	80277
CR28	3" x 2-1/2"	1.390	0.375	4.395	-	10	100	80287
CR34	3-1/2" x 2"	1.180	0.750	3.280	-	5	233	80347
CR35	3-1/2" x 2-1/2"	1.180	0.920	3.860	-	5	180	80357
CR36	3-1/2" x 3"	1.180	0.980	4.920	-	5	150	80367
CR42	4" x 2"	1.220	0.750	2.680	-	5	304	80427
CR43	4" x 2-1/2"	1.220	0.920	3.200	-	5	350	80437
CR44	4" x 3"	1.775	0.980	4.625	-	5	238	80447
CR45	4" x 3-1/2"	1.400	1.030	5.200	-	5	138	80457
CR46	5" x 4"	2.130	1.030	5.630	-	5	375	80467
CR47	6" x 5"	2.830	1.030	6.563	-	5	463	80468

CONDUIT HEX REDUCER BUSHINGS

FOR THREADED RIGID CONDUIT AND IMC

FEATURES

- Threaded for rigid conduit and IMC.
- Provided with hex shoulder.

STANDARD MATERIALS

Malleable Iron

STANDARD FINISH

Zinc Plated



Hex Type

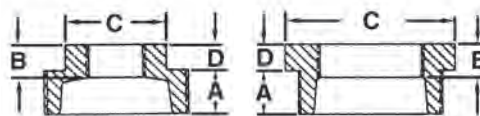

TYPE HCR1

CATALOG NUMBER	TRADE SIZE	DIM A	DIM B	DIM C	DIM D	UNIT PACK	MASTER PACK	LBS. / 100 PCS.	UPC #
HCR1	3/4" x 1/2"	0.63	0.53	1.15	0.22	-	100	8	80011
HCR2	1" x 1/2"	0.75	0.43	1.42	0.25	-	100	15	80021
HCR3	1" x 3/4"	0.75	0.50	1.42	0.25	-	100	12	80031
HCR4	1-1/4" x 1/2"	0.80	0.43	1.34	0.34	-	50	30	80041
HCR5	1-1/4" x 3/4"	0.80	0.50	1.76	0.28	-	50	50	80051
HCR6	1-1/4" x 1"	0.80	0.58	1.76	0.28	-	50	21	80061
HCR7	1-1/2" x 1/2"	0.83	0.43	1.34	0.37	-	50	48	80071
HCR8	1-1/2" x 3/4"	0.83	0.50	1.63	0.37	-	50	43	80081
HCR9	1-1/2" x 1"	0.83	0.58	2.00	0.31	-	50	40	80091
HCR10	1-1/2" x 1-1/4"	0.83	0.71	2.00	0.31	-	50	26	80101
HCR11	2" x 1/2"	0.88	0.43	1.34	0.41	-	25	85	80111
HCR12	2" x 3/4"	0.88	0.50	1.63	0.41	-	25	81	80121
HCR13	2" x 1"	0.88	0.58	1.95	0.41	-	25	73	80131
HCR14	2" x 1-1/4"	0.88	0.67	2.48	0.34	-	25	64	80141
HCR15	2" x 1-1/2"	0.88	0.70	2.48	0.34	-	25	55	80151
HCR16	2-1/2" x 1/2"	1.07	0.43	1.34	0.44	-	10	83	80161
HCR17	2-1/2" x 3/4"	1.07	0.50	1.63	0.44	-	10	80	80171
HCR18	2-1/2" x 1"	1.07	0.58	1.95	0.44	-	10	79	80181
HCR19	2-1/2" x 1-1/4"	1.07	0.67	2.39	0.44	-	10	74	80191
HCR20	2-1/2" x 1-1/2"	1.07	0.70	2.68	0.40	-	10	73	80201
HCR21	2-1/2" x 2"	1.07	0.75	2.98	0.37	-	10	76	80211
HCR22	3" x 1/2"	1.13	0.43	1.34	0.48	-	10	150	80221
HCR23	3" x 3/4"	1.13	0.50	1.63	0.48	-	10	120	80231
HCR24	3" x 1"	1.13	0.58	1.95	0.48	-	10	110	80241
HCR25	3" x 1-1/4"	1.13	0.67	2.39	0.48	-	10	100	80251
HCR26	3" x 1-1/2"	1.13	0.70	2.68	0.48	-	10	158	80261
HCR27	3" x 2"	1.13	0.75	3.28	0.48	-	10	188	80271
HCR28	3" x 2-1/2"	1.13	0.92	3.86	0.40	-	10	150	80281
HCR29	3-1/2" x 1/2"	1.18	0.43	1.85	0.52	-	10	160	80291
HCR30	3-1/2" x 3/4"	1.18	0.50	1.95	0.52	-	10	151	80301
HCR31	3-1/2" x 1"	1.18	0.58	1.95	0.52	-	10	144	80311
HCR32	3-1/2" x 1-1/4"	1.18	0.67	2.39	0.52	-	10	135	80321
HCR33	3-1/2" x 1-1/2"	1.18	0.70	3.28	0.52	-	10	130	80331
HCR34	3-1/2" x 2"	1.18	0.75	3.28	0.52	-	10	165	80341
HCR35	3-1/2" x 2-1/2"	1.18	0.92	3.86	0.52	-	10	172	80351
HCR36	3-1/2" x 3"	1.18	0.98	4.62	0.43	-	10	166	80361
HCR37	4" x 1/2"	1.22	0.50	1.95	0.60	-	5	215	80371
HCR38	4" x 3/4"	1.22	0.56	1.95	0.60	-	5	185	80381
HCR39	4" x 1"	1.22	0.58	1.95	0.60	-	5	175	80391
HCR40	4" x 1-1/4"	1.22	0.67	2.39	0.60	-	5	160	80401
HCR41	4" x 1-1/2"	1.22	0.70	2.68	0.60	-	5	153	80411
HCR42	4" x 2"	1.22	0.75	3.28	0.60	-	5	177	80421
HCR43	4" x 2-1/2"	1.22	0.92	3.86	0.60	-	5	225	80431
HCR44	4" x 3"	1.22	0.98	4.62	0.50	-	5	310	80441
HCR45	4" x 3-1/2"	1.22	1.03	5.20	0.50	-	5	218	80451
HCR46	5" x 4"	1.50	1.03	5.20	0.50	-	5	438	80461

CONDUIT REDUCING WASHERS

FOR THREADED RIGID CONDUIT AND IMC

APPLICATION

Reduce knockout size on sheet metal box, enclosure or cabinet.

Note: Two reducing washers are required for each knockout.

STANDARD MATERIALS

Galvanized Steel



Recess Type

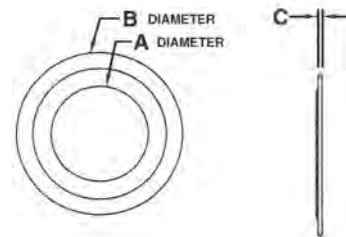

TYPE CW32

CATALOG NUMBER	TRADE SIZE	DIM A	DIM B	DIM C	UNIT PACK	MASTER PACK	LBS. / 100 PCS.	UPC #
CW19	1/2" x 1/4"	0.830	1.382	0.035	-	500	1	81197
CW20	1/2" x 3/8"	0.830	1.382	0.035	-	500	1	81207
CW21	3/4" x 1/2"	0.870	1.420	0.035	250	2500	1	81217
CW31	1" x 1/2"	0.870	1.710	0.035	250	2500	2	81506
CW32	1" x 3/4"	1.060	1.710	0.035	250	2500	2	81507
CW41	1-1/4" x 1/2"	0.870	2.080	0.035	100	1000	3	81508
CW42	1-1/4" x 3/4"	1.125	2.080	0.035	100	1000	3	81510
CW43	1-1/4" x 1"	1.380	2.080	0.035	100	1000	3	81512
CW51	1-1/2" x 1/2"	0.870	2.635	0.035	100	1000	6	81517
CW52	1-1/2" x 3/4"	1.060	2.635	0.035	100	1000	5	81527
CW53	1-1/2" x 1"	1.335	2.635	0.035	100	1000	4	81537
CW54	1-1/2" x 1-1/4"	1.690	2.635	0.035	100	1000	3	81547
CW61	2" x 1/2"	0.870	3.265	0.035	50	500	9	81617
CW62	2" x 3/4"	1.060	3.265	0.035	50	500	9	81627
CW63	2" x 1"	1.335	3.265	0.035	50	500	8	81637
CW64	2" x 1-1/4"	1.690	3.265	0.035	50	500	7	81647
CW65	2" x 1-1/2"	1.935	3.265	0.035	50	500	6	81657
CW71	2-1/2" x 1/2"	0.870	3.265	0.035	50	500	8	81717
CW72	2-1/2" x 3/4"	1.060	3.265	0.035	50	500	8	81727
CW73	2-1/2" x 1"	1.370	3.265	0.035	50	500	7	81737
CW74	2-1/2" x 1-1/4"	1.750	3.265	0.035	50	500	6	81747
CW75	2-1/2" x 1-1/2"	1.995	3.265	0.035	50	500	5	81757
CW76	2"-1/2 x 2"	2.425	3.265	0.035	50	500	4	81767
CW81	3" x 1/2"	0.870	4.490	0.040	25	250	17	81817
CW82	3" x 3/4"	1.060	4.490	0.040	25	250	17	81827
CW83	3" x 1"	1.360	4.490	0.040	25	250	19	81837
CW84	3" x 1-1/4"	1.750	4.490	0.040	25	250	18	81847
CW85	3" x 1-1/2"	1.995	4.490	0.040	25	250	15	81857
CW86	3" x 2"	2.100	4.490	0.040	25	250	13	81867
CW87	3" x 2-1/2"	2.840	4.490	0.040	25	250	12	81877
CW91	3-1/2" x 1/2"	0.870	5.000	0.060	10	100	32	81917
CW92	3-1/2" x 3/4"	1.060	5.000	0.060	10	100	33	81927
CW93	3-1/2" x 1"	1.380	5.000	0.060	10	100	31	81937
CW94	3-1/2" x 1-1/4"	1.710	5.000	0.060	10	100	29	81947
CW95	3-1/2" x 1-1/2"	1.950	5.000	0.060	10	100	58	81957
CW96	3-1/2" x 2"	2.435	5.000	0.060	10	100	30	81967
CW97	3-1/2" x 2-1/2"	2.920	5.000	0.060	10	100	25	81977
CW98	3-1/2" x 3"	3.560	5.000	0.060	10	100	19	81987
CW101	4" x 1/2"	0.870	5.500	0.065	10	100	40	81017
CW102	4" x 3/4"	1.060	5.500	0.065	10	100	37	81027
CW103	4" x 1"	1.380	5.500	0.065	10	100	38	81037
CW104	4" x 1-1/4"	1.715	5.500	0.065	10	100	36	81047
CW105	4" x 1-1/2"	1.970	5.500	0.065	10	100	35	81057
CW106	4" x 2"	2.435	5.500	0.065	10	100	37	81067
CW107	4" x 2-1/2"	2.920	5.500	0.065	10	100	33	81077
CW108	4" x 3"	3.560	5.500	0.065	10	100	24	81087
CW109	4" x 3-1/2"	4.050	5.500	0.065	10	100	22	81097

PIPE PLUGS

FOR THREADED RIGID CONDUIT AND IMC

APPLICATION

To close up a taped hole or hub.

FEATURES

→ Threaded (NPT)

STANDARD MATERIALS

Malleable Iron

STANDARD FINISH

Zinc Plated

Pipe Plugs

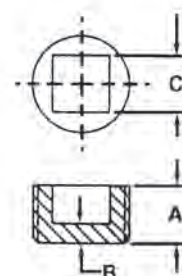
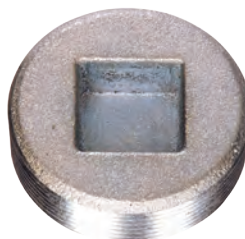

TYPE P10

CATALOG NUMBER	TRADE SIZE	DIM A	DIM B	DIM C	UNIT PACK	MASTER PACK	LBS. / 100 PCS.	UPC #
P10	1/2"	0.560	0.160	0.382	-	100	7	14101
P11	3/4"	0.630	0.180	0.508	-	100	12	14111
P12	1"	0.750	0.200	0.508	-	100	21	14121
P13	1-1/4"	0.800	0.759	0.220	-	100	33	14131
P14	1-1/2"	0.830	0.759	0.240	-	25	45	14141
P15	2"	0.880	0.884	0.260	-	25	78	14151
P16	2-1/2"	1.070	1.137	0.290	-	10	148	14161
P17	3"	1.130	1.391	0.310	-	10	219	14171
P18	3-1/2"	1.180	1.518	0.340	-	5	336	14181
P19	4"	1.220	2.022	0.370	-	5	378	14191
P20	5"	1.310	2.275	0.400	-	5	540	14201
P21	6"	1.375	2.530	0.437	-	5	780	14211

Square Head Plugs are available upon request. Please call factory for pricing and availability.

APPLICATION

To close up a taped hole or hub.

FEATURES

→ Threaded (NPT)

STANDARD MATERIALS

Zinc Die Cast

Slotted Plugs

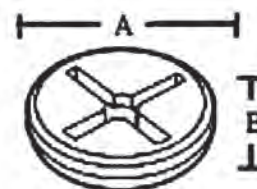

TYPE P3

CATALOG NUMBER	TRADE SIZE	DIM A	DIM B	UNIT PACK	MASTER PACK	LBS. / 100 PCS.	UPC #
P1	1/2"	0.560	0.160	100	1000	1	14012
P2	3/4"	0.630	0.180	100	1000	2	14022
P3	1"	0.750	0.200	100	1000	4	14032

FLOOR FLANGES AND ENLARGERS

APPLICATION

Used to support rigid conduit or IMC to the floor.

FEATURES

→ Heavy Duty Casting

STANDARD MATERIALS

Malleable Iron

STANDARD FINISH

Zinc Plated

Malleable Iron Floor Flanges, Threaded Insert



TYPE 2F

CATALOG NUMBER	TRADE SIZE	BASE DIM	UNIT PACK	MASTER PACK	LBS. / 100 PCS.	UPC #
1F	1/2"	3.00	-	25	47	12311
2F	3/4"	3.38	-	25	50	12321
3F	1"	3.38	-	25	86	12331
4F	1-1/4"	4.00	-	25	79	12341
5F	1-1/2"	4.38	-	25	130	12351
6F	2"	4.88	-	25	216	12361

APPLICATION

Enlarges a threaded hub in an enclosure or conduit fittings.

STANDARD MATERIALS

Malleable Iron

STANDARD FINISH

Zinc Plated

Malleable Iron Enlargers Male-Female

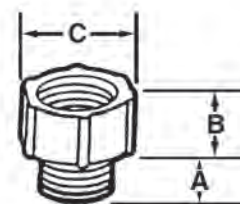

TYPE E35

CATALOG NUMBER	TRADE SIZE	DIM A	DIM B	DIM C	UNIT PACK	MASTER PACK	LBS. / 100 PCS.	UPC #
E35	1/2" M - 3/4" F	0.56	0.19	1.38	25	250	20	14351
E36	3/4" M - 1" F	0.56	0.94	1.75	10	100	45	14361
E37	1" M - 1-1/4" F	0.56	1.06	2.25	10	100	65	14371
E38	1-1/4" M - 1-1/2" F	0.63	1.25	2.38	10	100	87	14381



EMT FITTINGS

Aluminum Set-Screw Conduit Bodies.....	96	Steel Raintight EMT Compression Connectors.....	111
Aluminum Set-Screw Conduit Bodies with Cover and Gasket.....	99	Steel Raintight EMT Compression Couplings.....	112
Aluminum Combination Conduit Bodies with Cover & Gasket.....	102	Zinc EMT Set-Screw Connectors.....	113
Conduit Body Covers.....	105	Zinc EMT Set-Screw Couplings.....	114
Neoprene Gaskets.....	106	Zinc EMT Compression Connectors.....	115
Steel EMT Set-Screw Connectors.....	107	Zinc EMT Compression Couplings.....	116
Steel EMT Set-Screw Couplings.....	108	Combination Couplings.....	117
Steel EMT Compression Connectors.....	109	Zinc 90° Pull Elbows.....	118
Steel EMT Compression Couplings.....	110	Zinc Offset Connectors.....	119
		EMT Straps.....	120
		Zinc Combination Couplings.....	121

ALUMINUM SET-SCREW CONDUIT BODIES

FOR EMT CONDUIT

APPLICATION

To provide access to conductors for pulling, splicing, and maintenance. Used for thinwall conduit.

FEATURES

- Die cast from high-strength, corrosion and weather resistant, copper-free aluminum alloy.
- Flat back design for easy mounting close to walls.

STANDARD MATERIALS

1/2" - 2"
Die Cast/Copper-Free
Aluminum

2 1/2" - 4"
Sand-Cast Copper-Free
Aluminum

STANDARD FINISH

Aluminum Enameled



TYPE C1AT

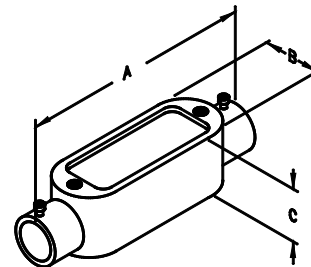

CATALOG NUMBER	TRADE SIZE	DIM A	DIM B	DIM C	MAX WIRE SIZE	VOL. CU.IN.	UNIT PACK	MASTER PACK	LBS. / 100 PCS.	UPC #
C TYPE										
C1AT	1/2"	4.69	1.38	1.31	N/A	4.35	10	50	21	49015
C2AT	3/4"	5.50	1.56	1.63	3 #6 AWG	7.30	10	50	33	49025
C3AT	1"	6.48	1.88	1.88	3 #4 AWG	12.20	5	25	46	49035
C4AT	1-1/4"	8.31	2.50	2.50	3 #2 AWG	33.50	-	10	82	49045
C5AT	1-1/2"	8.38	2.50	2.50	3 #1/0 AWG	33.50	-	10	85	49055
C6AT	2"	10.31	3.38	3.38	3 #4/0 AWG	69.50	-	5	188	49065
C7AT	2-1/2"	13.12	4.50	4.00	3 #250 MCM	69.50	-	1	325	49075
C8AT	3"	13.19	4.56	4.56	3 #250 MCM	188.00	-	1	399	49085
C9AT	3-1/2"	16.12	5.69	5.63	3 #300 MCM	307.00	-	1	975	49095
C10AT	4"	16.12	5.69	5.63	3 #300 MCM	309.00	-	1	875	49005



TYPE LB1AT

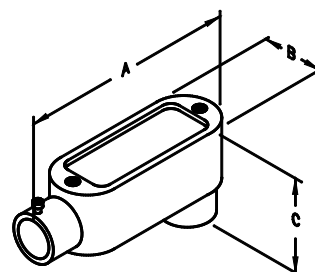

CATALOG NUMBER	TRADE SIZE	DIM A	DIM B	DIM C	MAX WIRE SIZE	VOL. CU.IN.	UNIT PACK	MASTER PACK	LBS. / 100 PCS.	UPC #
LB TYPE										
LB1AT	1/2"	4.31	1.31	2.19	N/A	4.35	10	50	24	45015
LB2AT	3/4"	5.06	1.56	2.44	3 #6 AWG	7.25	10	50	37	45025
LB3AT	1"	5.87	1.75	2.75	3 #4 AWG	12.20	5	25	46	45035
LB4AT	1-1/4"	7.81	2.50	3.44	3 #2 AWG	32.30	-	10	98	45045
LB5AT	1-1/2"	7.81	2.50	3.44	3 #2 AWG	33.80	-	10	91	45055
LB6AT	2"	10.06	3.12	4.31	3 #4/0 AWG	71.20	-	5	222	45065
LB7AT	2-1/2"	12.81	4.50	5.31	3 #4/0 AWG	71.20	-	1	366	45075
LB8AT	3"	12.81	4.50	5.94	3 #4/0 AWG	183.50	-	1	430	45085
LB9AT	3-1/2"	15.62	5.56	7.06	3 #400 MCM	304.90	-	1	937	45095
LB10AT	4"	15.62	5.56	7.06	3 #400 MCM	308.00	-	1	851	45105

ALUMINUM SET-SCREW CONDUIT BODIES

FOR EMT CONDUIT

APPLICATION

To provide access to conductors for pulling, splicing, and maintenance. Used for thinwall conduit.

FEATURES

- Die cast from high-strength, corrosion and weather resistant, copper-free aluminum alloy.
- Flat back design for easy mounting close to walls.

STANDARD MATERIALS

1/2" - 2"
Die Cast/Copper-Free
Aluminum

2 1/2" - 4"
Sand-Cast Copper-Free
Aluminum

STANDARD FINISH

Aluminum Enameled



TYPE LL1AT

CATALOG NUMBER	TRADE SIZE	DIM A	DIM B	DIM C	MAX WIRE SIZE	VOL. CU.IN.	UNIT PACK	MASTER PACK	LBS. / 100 PCS.	UPC #
LL TYPE										
LL1AT	1/2"	4.31	2.06	1.38	N/A	4.35	10	50	25	46015
LL2AT	3/4"	5.06	2.25	1.63	3 #6 AWG	7.30	10	50	37	46025
LL3AT	1"	5.87	2.63	1.88	3 #4 AWG	12.20	5	25	45	46035
LL4AT	1-1/4"	7.81	3.63	2.50	3 #2 AWG	35.80	-	10	98	46045
LL5AT	1-1/2"	7.81	3.63	2.50	3 #1/0 AWG	35.80	-	10	92	46055
LL6AT	2"	10.06	4.44	3.38	3 #4/0 AWG	69.70	-	5	245	46065
LL7AT	2-1/2"	12.81	5.75	4.00	3 #300 MCM	69.70	-	1	388	46066
LL8AT	3"	12.81	5.75	4.50	3 #350 MCM	186.00	-	1	439	46067
LL9AT	3-1/2"	15.62	11.69	5.63	3 #350 MCM	306.00	-	1	924	46068
LL10AT	4"	15.62	11.69	5.63	3 #350 MCM	308.00	-	1	882	46069



TYPE LR1AT

CATALOG NUMBER	TRADE SIZE	DIM A	DIM B	DIM C	MAX WIRE SIZE	VOL. CU.IN.	UNIT PACK	MASTER PACK	LBS. / 100 PCS.	UPC #
LR TYPE										
LR1AT	1/2"	4.31	2.06	1.38	N/A	4.35	10	50	23	47015
LR2AT	3/4"	5.06	2.25	1.63	3 #6 AWG	7.30	10	50	38	47025
LR3AT	1"	5.87	2.63	1.88	3 #4 AWG	12.20	5	25	49	47035
LR4AT	1-1/4"	7.81	3.63	2.50	3 #2 AWG	35.80	-	10	98	47045
LR5AT	1-1/2"	7.81	3.63	2.50	3 #1/0 AWG	35.80	-	10	94	47055
LR6AT	2"	10.06	4.44	3.38	3 #4/0 AWG	69.70	-	5	254	47065
LR7AT	2-1/2"	12.81	5.75	4.00	3 #300 MCM	69.70	-	1	366	47066
LR8AT	3"	12.81	5.75	4.50	3 #350 MCM	186.00	-	1	406	47067
LR9AT	3-1/2"	15.62	11.69	5.63	3 #350 MCM	306.00	-	1	928	47068
LR10AT	4"	15.62	11.69	5.63	3 #350 MCM	308.00	-	1	902	47069

ALUMINUM SET-SCREW CONDUIT BODIES

FOR EMT CONDUIT

APPLICATION

To provide access to conductors for pulling, splicing, and maintenance. Used for thinwall conduit.

FEATURES

- Die cast from high-strength, corrosion and weather resistant, copper-free aluminum alloy.
- Flat back design for easy mounting close to walls.

STANDARD MATERIALS

1/2" - 2"
Die Cast/Copper-Free
Aluminum

2 1/2" - 4"
Sand-Cast Copper-Free
Aluminum

STANDARD FINISH

Aluminum Enameled

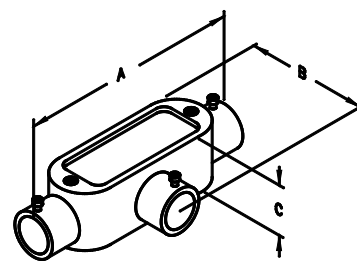

TYPE T1AT

CATALOG NUMBER	TRADE SIZE	DIM A	DIM B	DIM C	MAX WIRE SIZE	VOL. CU.IN.	UNIT PACK	MASTER PACK	LBS. / 100 PCS.	UPC #
T TYPE										
T1AT	1/2"	4.75	2.06	1.38	N/A	4.35	10	50	23	48015
T2AT	3/4"	5.56	2.25	1.63	3 #6 AWG	7.25	10	50	38	48025
T3AT	1"	6.44	2.63	1.88	3 #4 AWG	12.20	5	25	53	48035
T4AT	1-1/4"	8.25	3.56	2.50	3 #2 AWG	33.10	-	10	100	48045
T5AT	1-1/2"	8.38	3.56	2.50	3 #1/0 AWG	33.10	-	10	98	48055
T6AT	2"	10.69	4.38	3.13	3 #4/0 AWG	67.00	-	5	265	48065
T7AT	2-1/2"	13.25	5.75	4.00	3 #4/0 AWG	67.00	-	1	375	48066
T8AT	3"	13.25	5.75	4.50	3 #4/0 AWG	175.00	-	1	444	48067
T9AT	3-1/2"	16.13	7.69	5.63	3 #400 MCM	298.00	-	1	1146	48068
T10AT	4"	16.13	7.69	5.63	3 #400 MCM	300.00	-	1	1079	48069

ALUMINUM SET-SCREW CONDUIT BODIES WITH COVER AND GASKET

FOR EMT CONDUIT

APPLICATION

To provide access to conductors for pulling, splicing, and maintenance. Used for thinwall conduit.

FEATURES

- Die cast from high-strength, corrosion and weather resistant, copper-free aluminum alloy.
- Flat back design for easy mounting close to walls.
- Assembled with neoprene gasket and stamped cover.

STANDARD MATERIALS

1/2" - 2"
Die Cast/Copper-Free
Aluminum

2 1/2" - 4"
Sand-Cast Copper-Free
Aluminum

STANDARD FINISH

Aluminum Enameled



TYPE C1ATCG

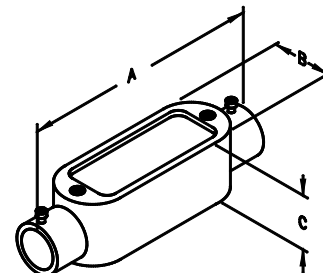

CATALOG NUMBER	TRADE SIZE	DIM A	DIM B	DIM C	MAX WIRE SIZE	VOL. CU.IN.	UNIT PACK	MASTER PACK	LBS. / 100 PCS.	UPC #
C TYPE										
C1ATCG	1/2"	4.69	1.38	1.31	N/A	4.35	10	50	21	10400
C2ATCG	3/4"	5.50	1.56	1.63	3 #6 AWG	7.30	10	50	33	10401
C3ATCG	1"	6.48	1.88	1.88	3 #4 AWG	12.20	5	25	46	10402
C4ATCG	1-1/4"	8.31	2.50	2.50	3 #2 AWG	33.50	-	10	82	10403
C5ATCG	1-1/2"	8.38	2.50	2.50	3 #1/0 AWG	33.50	-	10	85	10404
C6ATCG	2"	10.31	3.38	3.38	3 #4/0 AWG	69.50	-	5	188	10405
C7ATCG	2-1/2"	13.12	4.50	4.00	3 #250 MCM	69.50	-	1	325	10406
C8ATCG	3"	13.19	4.56	4.56	3 #250 MCM	188.00	-	1	399	10407
C9ATCG	3-1/2"	16.12	5.69	5.63	3 #300 MCM	307.00	-	1	975	10408
C10ATCG	4"	16.12	5.69	5.63	3 #300 MCM	309.00	-	1	875	10409



TYPE LB1ATCG

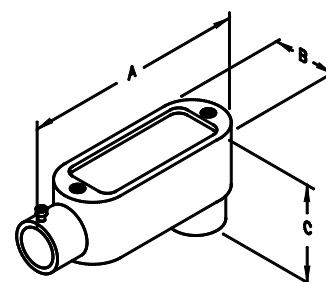

CATALOG NUMBER	TRADE SIZE	DIM A	DIM B	DIM C	MAX WIRE SIZE	VOL. CU.IN.	UNIT PACK	MASTER PACK	LBS. / 100 PCS.	UPC #
LB TYPE										
LB1ATCG	1/2"	4.31	1.31	2.19	N/A	4.35	10	50	24	10410
LB2ATCG	3/4"	5.06	1.56	2.44	3 #6 AWG	7.25	10	50	37	10411
LB3ATCG	1"	5.87	1.75	2.75	3 #4 AWG	12.20	5	25	46	10412
LB4ATCG	1-1/4"	7.81	2.50	3.44	3 #2 AWG	32.30	-	10	98	10413
LB5ATCG	1-1/2"	7.81	2.50	3.44	3 #2 AWG	33.80	-	10	91	10414
LB6ATCG	2"	10.06	3.12	4.31	3 #4/0 AWG	71.20	-	5	222	10415
LB7ATCG	2-1/2"	12.81	4.50	5.31	3 #4/0 AWG	71.20	-	1	366	10416
LB8ATCG	3"	12.81	4.50	5.94	3 #4/0 AWG	183.50	-	1	430	10417
LB9ATCG	3-1/2"	15.62	5.56	7.06	3 #400 MCM	304.90	-	1	937	10418
LB10ATCG	4"	15.62	5.56	7.06	3 #400 MCM	308.00	-	1	851	10419

ALUMINUM SET-SCREW CONDUIT BODIES WITH COVER AND GASKET

FOR EMT CONDUIT

APPLICATION

To provide access to conductors for pulling, splicing, and maintenance. Used for thinwall conduit.

FEATURES

- Die cast from high-strength, corrosion and weather resistant, copper-free aluminum alloy.
- Flat back design for easy mounting close to walls.
- Assembled with neoprene gasket and stamped cover.

STANDARD MATERIALS

1/2" - 2"
Die Cast/Copper-Free
Aluminum

2 1/2" - 4"
Sand-Cast Copper-Free
Aluminum

STANDARD FINISH

Aluminum Enameled



TYPE LL1ATCG

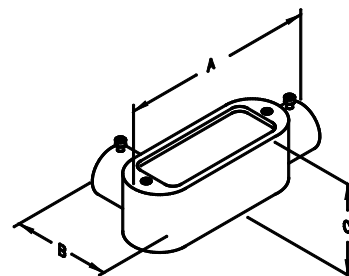

CATALOG NUMBER	TRADE SIZE	DIM A	DIM B	DIM C	MAX WIRE SIZE	VOL. CU.IN.	UNIT PACK	MASTER PACK	LBS. / 100 PCS.	UPC #
LL TYPE										
LL1ATCG	1/2"	4.31	2.06	1.38	N/A	4.35	10	50	25	10440
LL2ATCG	3/4"	5.06	2.25	1.63	3 #6 AWG	7.30	10	50	37	10441
LL3ATCG	1"	5.87	2.63	1.88	3 #4 AWG	12.20	5	25	45	10442
LL4ATCG	1-1/4"	7.81	3.63	2.50	3 #2 AWG	35.80	-	10	98	10443
LL5ATCG	1-1/2"	7.81	3.63	2.50	3 #1/0 AWG	35.80	-	10	92	10444
LL6ATCG	2"	10.06	4.44	3.38	3 #4/0 AWG	69.70	-	5	245	10445
LL7ATCG	2-1/2"	12.81	5.75	4.00	3 #300 MCM	69.70	-	1	388	10446
LL8ATCG	3"	12.81	5.75	4.50	3 #350 MCM	186.00	-	1	439	10447
LL9ATCG	3-1/2"	15.62	11.69	5.63	3 #350 MCM	306.00	-	1	924	10448
LL10ATCG	4"	15.62	11.69	5.63	3 #350 MCM	308.00	-	1	882	10449



TYPE LR1ATCG

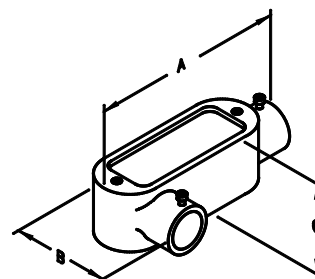

CATALOG NUMBER	TRADE SIZE	DIM A	DIM B	DIM C	MAX WIRE SIZE	VOL. CU.IN.	UNIT PACK	MASTER PACK	LBS. / 100 PCS.	UPC #
LR TYPE										
LR1ATCG	1/2"	4.31	2.06	1.38	N/A	4.35	10	50	23	10430
LR2ATCG	3/4"	5.06	2.25	1.63	3 #6 AWG	7.30	10	50	38	10431
LR3ATCG	1"	5.87	2.63	1.88	3 #4 AWG	12.20	5	25	49	10432
LR4ATCG	1-1/4"	7.81	3.63	2.50	3 #2 AWG	35.80	-	10	98	10433
LR5ATCG	1-1/2"	7.81	3.63	2.50	3 #1/0 AWG	35.80	-	10	94	10434
LR6ATCG	2"	10.06	4.44	3.38	3 #4/0 AWG	69.70	-	5	254	10435
LR7ATCG	2-1/2"	12.81	5.75	4.00	3 #300 MCM	69.70	-	1	366	10436
LR8ATCG	3"	12.81	5.75	4.50	3 #350 MCM	186.00	-	1	406	10437
LR9ATCG	3-1/2"	15.62	11.69	5.63	3 #350 MCM	306.00	-	1	928	10438
LR10ATCG	4"	15.62	11.69	5.63	3 #350 MCM	308.00	-	1	902	10439



Steel Electric
PRODUCTS

Ph: 718.259.6100 / 800.626.1223 Fax: 718.331.1874

www.sepco-usa.com

ALUMINUM SET-SCREW CONDUIT BODIES WITH COVER AND GASKET

FOR EMT CONDUIT

APPLICATION

To provide access to conductors for pulling, splicing, and maintenance. Used for thinwall conduit.

FEATURES

- Die cast from high-strength, corrosion and weather resistant, copper-free aluminum alloy.
- Flat back design for easy mounting close to walls.
- Assembled with neoprene gasket and stamped cover.

STANDARD MATERIALS

1/2" - 2"
Die Cast/Copper-Free
Aluminum

2 1/2" - 4"
Sand-Cast Copper-Free
Aluminum

STANDARD FINISH

Aluminum Enameled



TYPE T1ATCG

CATALOG NUMBER	TRADE SIZE	DIM A	DIM B	DIM C	MAX WIRE SIZE	VOL. CU.IN.	UNIT PACK	MASTER PACK	LBS./100 PCS.	UPC #
T TYPE										
T1ATCG	1/2"	4.75	2.06	1.38	N/A	4.35	10	50	23	10420
T2ATCG	3/4"	5.56	2.25	1.63	3 #6 AWG	7.25	10	50	38	10421
T3ATCG	1"	6.44	2.63	1.88	3 #4 AWG	12.20	5	25	53	10422
T4ATCG	1-1/4"	8.25	3.56	2.50	3 #2 AWG	33.10	-	10	100	10423
T5ATCG	1-1/2"	8.38	3.56	2.50	3 #1/0 AWG	33.10	-	10	98	10424
T6ATCG	2"	10.69	4.38	3.13	3 #4/0 AWG	67.00	-	5	265	10425
T7ATCG	2-1/2"	13.25	5.75	4.00	3 #4/0 AWG	67.00	-	1	375	10426
T8ATCG	3"	13.25	5.75	4.50	3 #4/0 AWG	175.00	-	1	444	10427
T9ATCG	3-1/2"	16.13	7.69	5.63	3 #400 MCM	298.00	-	1	1146	10428
T10ATCG	4"	16.13	7.69	5.63	3 #400 MCM	300.00	-	1	1079	10429

ALUMINUM COMBINATION CONDUIT BODIES WITH COVER & GASKET

FOR THREADED RIGID CONDUIT, IMC AND EMT

APPLICATION

Used with threaded rigid conduit, IMC and EMT for providing access to the interior of conduit system for pulling, splicing, inspection and maintenance.

FEATURES

- Assembled with slotted/Robertson combination screws.
- Assembled with neoprene gasket and stamped cover.
- Tapered threaded hubs (NPT).
- Die cast from high-strength, corrosion and weather resistant, copper-free aluminum alloy.
- Flat back design for easy mounting close to walls.
- Suitable for use in concrete.

STANDARD MATERIALS

Die cast/Copper-free Aluminum

STANDARD FINISH

Aluminum Enameled



TYPE C1CA

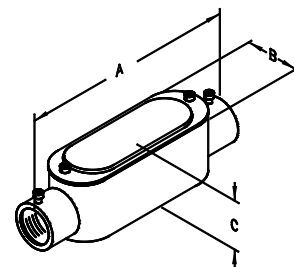

CATALOG NUMBER	TRADE SIZE	DIM A	DIM B	DIM C	MAX WIRE SIZE	VOL. CU.IN.	UNIT PACK	MASTER PACK	LBS. / 100 PCS.	UPC #
C TYPE										
C1CA	1/2"	4.69	1.38	1.56	N/A	4.35	10	50	28	64401
C2CA	3/4"	5.50	1.56	1.75	3 #6 AWG	7.30	10	50	41	64402
C3CA	1"	6.48	1.88	2.13	3 #4 AWG	12.20	5	25	56	64403
C4CA	1-1/4"	8.31	2.50	2.75	3 #2 AWG	33.50	-	10	101	64404
C5CA	1-1/2"	8.38	2.50	2.75	3 #1/0 AWG	33.50	-	10	104	64405
C6CA	2"	10.31	3.38	3.63	3 #4/0 AWG	69.50	-	5	220	64406



TYPE LB1CA

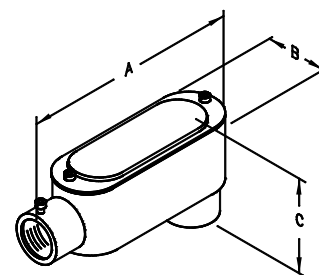

CATALOG NUMBER	TRADE SIZE	DIM A	DIM B	DIM C	MAX WIRE SIZE	VOL. CU.IN.	UNIT PACK	MASTER PACK	LBS. / 100 PCS.	UPC #
LB TYPE										
LB1CA	1/2"	4.31	1.31	2.44	N/A	4.35	10	50	24	64101
LB2CA	3/4"	5.06	1.56	2.69	3 #6 AWG	7.25	10	50	37	64102
LB3CA	1"	5.87	1.75	3.00	3 #4 AWG	12.20	5	25	46	64103
LB4CA	1-1/4"	7.81	2.50	3.69	3 #2 AWG	32.30	-	10	98	64104
LB5CA	1-1/2"	7.81	2.50	3.69	3 #2 AWG	33.80	-	10	91	64105
LB6CA	2"	10.06	3.12	4.56	3 #4/0 AWG	71.20	-	5	222	64106

ALUMINUM COMBINATION CONDUIT BODIES WITH COVER & GASKET

FOR THREADED RIGID CONDUIT, IMC AND EMT

APPLICATION

Used with threaded rigid conduit, IMC and EMT for providing access to the interior of conduit system for pulling, splicing, inspection and maintenance.

FEATURES

- Assembled with slotted/Robertson combination screws.
- Assembled with neoprene gasket and stamped cover.
- Tapered threaded hubs (NPT).
- Die cast from high-strength, corrosion and weather resistant, copper-free aluminum alloy.
- Flat back design for easy mounting close to walls.
- Suitable for use in concrete.

STANDARD MATERIALS

Die cast/Copper-free Aluminum

STANDARD FINISH

Aluminum Enameled



TYPE LL1CA

CATALOG NUMBER	TRADE SIZE	DIM A	DIM B	DIM C	MAX WIRE SIZE	VOL. CU.IN.	UNIT PACK	MASTER PACK	LBS. / 100 PCS.	UPC #
LL TYPE										
LL1CA	1/2"	4.31	2.06	1.63	N/A	4.35	10	50	25	64201
LL2CA	3/4"	5.06	2.25	1.88	3 #6 AWG	7.30	10	50	37	64202
LL3CA	1"	5.87	2.63	2.13	3 #4 AWG	12.20	5	25	45	64203
LL4CA	1-1/4"	7.81	3.63	2.75	3 #2 AWG	35.80	-	10	98	64204
LL5CA	1-1/2"	7.81	3.63	2.75	3 #1/0 AWG	35.80	-	10	92	64205
LL6CA	2"	10.06	4.44	3.63	3 #4/0 AWG	69.70	-	5	245	64206

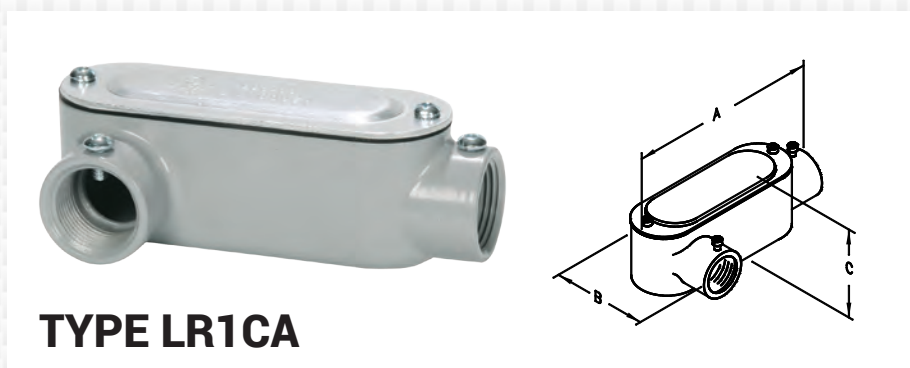

TYPE LR1CA

CATALOG NUMBER	TRADE SIZE	DIM A	DIM B	DIM C	MAX WIRE SIZE	VOL. CU.IN.	UNIT PACK	MASTER PACK	LBS. / 100 PCS.	UPC #
LR TYPE										
LR1CA	1/2"	4.31	2.06	1.63	N/A	4.35	10	50	23	64301
LR2CA	3/4"	5.06	2.25	1.88	3 #6 AWG	7.30	10	50	38	64302
LR3CA	1"	5.87	2.63	2.13	3 #4 AWG	12.20	5	25	49	64303
LR4CA	1-1/4"	7.81	3.63	2.75	3 #2 AWG	35.80	-	10	98	64304
LR5CA	1-1/2"	7.81	3.63	2.75	3 #1/0 AWG	35.80	-	10	94	64305
LR6CA	2"	10.06	4.44	3.63	3 #4/0 AWG	69.70	-	5	254	64306

ALUMINUM COMBINATION CONDUIT BODIES WITH COVER & GASKET

FOR THREADED RIGID CONDUIT, IMC AND EMT

APPLICATION

Used with threaded rigid conduit, IMC and EMT for providing access to the interior of conduit system for pulling, splicing, inspection and maintenance.

FEATURES

- Assembled with slotted/Robertson combination screws.
- Assembled with neoprene gasket and stamped cover.
- Tapered threaded hubs (NPT).
- Die cast from high-strength, corrosion and weather resistant, copper-free aluminum alloy.
- Flat back design for easy mounting close to walls.
- Suitable for use in concrete.

STANDARD MATERIALS

Die cast/Copper-free Aluminum

STANDARD FINISH

Aluminum Enameled



TYPE T1CA

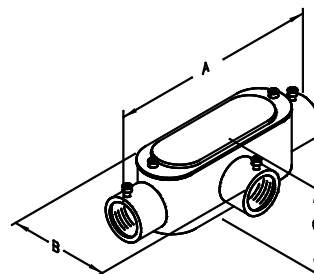

CATALOG NUMBER	TRADE SIZE	DIM A	DIM B	DIM C	MAX WIRE SIZE	VOL. CU.IN.	UNIT PACK	MASTER PACK	LBS. / 100 PCS.	UPC #
T TYPE										
T1CA	1/2"	4.75	2.06	1.63	N/A	4.35	10	50	23	64501
T2CA	3/4"	5.56	2.25	1.88	3 #6 AWG	7.25	10	50	38	64502
T3CA	1"	6.44	2.63	2.13	3 #4 AWG	12.20	5	25	53	64503
T4CA	1-1/4"	8.25	3.56	2.75	3 #2 AWG	33.10	-	10	100	64504
T5CA	1-1/2"	8.38	3.56	2.75	3 #1/0 AWG	33.10	-	10	98	64505
T6CA	2"	10.69	4.38	3.63	3 #4/0 AWG	67.00	-	5	265	64506

CONDUIT BODY COVERS

STEEL AND ALUMINUM COVERS

APPLICATION

Used with conduit bodies to cover opening.

FEATURES

- Assembled with captive zinc plated steel screws.

STANDARD MATERIALS

Steel

STANDARD FINISH

Zinc plated



TYPE 02

CATALOG NUMBER	TRADE SIZE	DIM A	DIM B	UNIT PACK	MASTER PACK	LBS. / 100 PCS.	UPC #
Steel Covers							
01	1/2"	3.875	1.310	25	250	9	49017
02	3/4"	4.625	1.520	25	250	13	49027
03	1"	5.315	1.710	20	200	19	49037
04	1-1/4" - 1-1/2"	7.240	2.510	25	100	31	49047
05	2"	9.484	3.110	-	50	50	49057
06	2-1/2" - 3"	14.937	5.500	-	10	94	49067
07	3-1/2" - 4"	15.000	6.000	-	10	138	49077

APPLICATION

Used with conduit bodies to cover opening.

FEATURES

- Assembled with captive zinc plated steel screws.
- Stamped from high-strength aluminum, corrosion and weather resistant copperfree aluminum alloy.

STANDARD MATERIALS

Stamped Aluminum



TYPE 02A

CATALOG NUMBER	TRADE SIZE	DIM A	DIM B	UNIT PACK	MASTER PACK	LBS. / 100 PCS.	UPC #
Aluminum Covers							
01A	1/2"	3.90	1.37	25	250	6	49105
02A	3/4"	4.70	1.60	25	250	10	49205
03A	1"	5.40	1.78	20	200	14	49305
04A	1-1/4" - 1-1/2"	7.25	2.52	25	100	18	49405
05A	2"	9.50	3.11	-	50	20	49505
06A	2-1/2" - 3"	12.13	4.45	-	10	33	49605
07A	3-1/2" - 4"	14.94	5.50	-	10	62	49705

CONDUIT BODY COVERS

NEOPRENE GASKETS

APPLICATION

Gasket used with conduit bodies for a raintight seal.

STANDARD MATERIALS

Neoprene Rubber

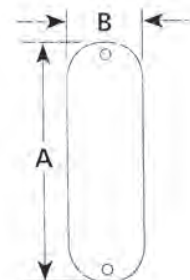

TYPE 11

CATALOG NUMBER	TRADE SIZE	DIM A	DIM B	UNIT PACK	MASTER PACK	LBS. / 100 PCS.	UPC #
Neoprene Gaskets							
10	1/2"	3.90	1.37	200	2000	3	49910
11	3/4"	4.60	1.56	100	1000	3	49911
12	1"	5.34	1.73	100	1000	3	49912
13	1-1/4" - 1-1/2"	7.25	2.51	50	500	6	49913
14	2"	9.50	3.05	25	100	11	49914
15	2-1/2" - 3"	12.13	4.39	-	10	13	49915
16	3-1/2" - 4"	14.88	5.43	-	10	28	49916

STEEL EMT SET-SCREW CONNECTORS

FOR EMT CONDUIT

APPLICATION

To ground and secure E.M.T. raceways to boxes and enclosures.

FEATURES

- Heavy steel walls
- Concrete tight
- Pre-set/Pre-staked set screws
- Male hub threads NPS
- Three-way combination screws

STANDARD MATERIALS

Steel

STANDARD FINISH

Zinc Plated

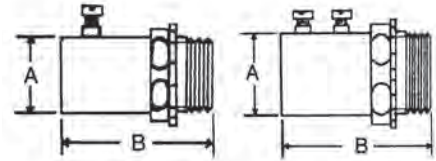

TYPE S1111

CATALOG NUMBER	TRADE SIZE	KO SIZE	DIM A	DIM B	UNIT PACK	MASTER PACK	LBS. / 100 PCS.	UPC #
S1110	1/2"	1/2"	0.87	1.53	50	500	9	62007
S1111	3/4"	3/4"	1.10	1.58	25	250	13	62017
S1112	1"	1"	1.36	1.83	50	200	20	62027
*S1112A	1-1/4"	1-1/4"	1.73	2.34	25	100	36	62037
*S1112B	1-1/2"	1-1/2"	1.97	2.27	10	40	45	62047
*S1112C	2"	2"	2.45	2.40	5	20	64	62057
*S1112D	2-1/2"	2-1/2"	3.10	3.18	-	12	130	62067
*S1112E	3"	3"	3.72	3.81	-	12	140	62077
*S1112E1	3-1/2"	3-1/2"	4.24	4.31	-	6	180	62087
*S1112F	4"	4"	4.74	4.87	-	6	225	62097

* Furnished with two set-screws

Insulated Throat

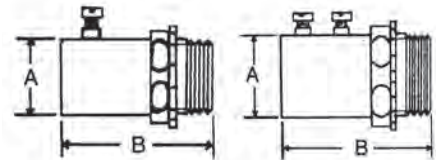

TYPE S4067

CATALOG NUMBER	TRADE SIZE	KO SIZE	DIM A	DIM B	UNIT PACK	MASTER PACK	LBS. / 100 PCS.	UPC #
S4066	1/2"	1/2"	0.87	1.53	50	500	9	62003
S4067	3/4"	3/4"	1.10	1.58	25	250	13	62013
S4068	1"	1"	1.36	1.83	50	200	20	62023
*S4069	1-1/4"	1-1/4"	1.73	2.34	25	100	36	62033
*S4070	1-1/2"	1-1/2"	1.97	2.27	10	40	45	62043
*S4071	2"	2"	2.45	2.40	5	20	64	62053
*S4072	2-1/2"	2-1/2"	3.10	3.18	-	12	130	62063
*S4073	3"	3"	3.72	3.81	-	12	140	62073
*S4074	3-1/2"	3-1/2"	4.24	4.31	-	6	180	62083
*S4075	4"	4"	4.74	4.87	-	6	225	62093

* Furnished with two set-screws

STEEL EMT SET-SCREW COUPLINGS

FOR EMT CONDUIT

APPLICATION

To ground and secure E.M.T. raceway sections together.

FEATURES

- Heavy steel walls
- Concrete tight
- Pre-set/Pre-staked set screws
- Three-way combination screws

STANDARD MATERIALS

Steel

STANDARD FINISH

Zinc Plated

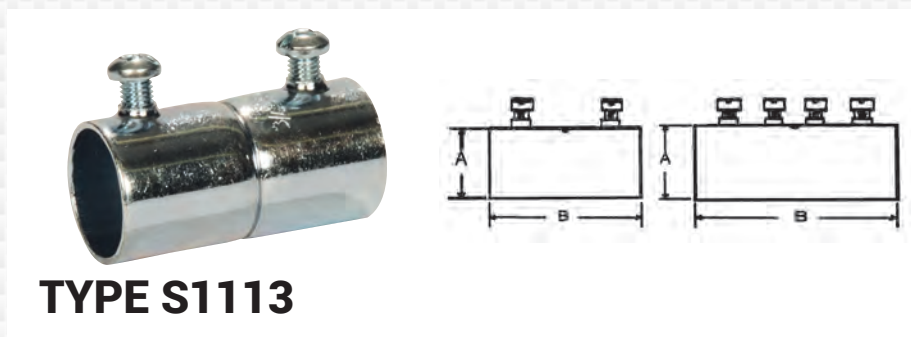

TYPE S1113

CATALOG NUMBER	TRADE SIZE	DIM A	DIM B	UNIT PACK	MASTER PACK	LBS. / 100 PCS.	UPC #
S1113	1/2"	0.87	1.63	50	500	8	62107
S1114	3/4"	1.10	1.86	25	250	13	62117
S1115	1"	1.36	2.31	50	200	20	62127
*S1115A	1-1/4"	1.73	2.76	25	100	40	62137
*S1115B	1-1/2"	1.97	3.00	10	40	58	62147
*S1115C	2"	2.45	3.27	5	20	65	62157
*S1115D	2-1/2"	3.10	4.00	-	12	130	62167
*S1115E	3"	3.72	4.25	-	12	140	62177
*S1115E1	3-1/2"	4.24	4.50	-	6	217	62187
*S1115F	4"	4.74	4.75	-	6	250	62197

* Furnished with four set-screws

STEEL EMT COMPRESSION CONNECTORS

FOR EMT CONDUIT

APPLICATION

To ground and secure E.M.T. raceways to boxes and enclosures.

FEATURES

- Male hub threads NPS
- Concrete tight
- Heavy Steel Walls

STANDARD MATERIALS

Steel

STANDARD FINISH

Zinc Plated



TYPE S1011

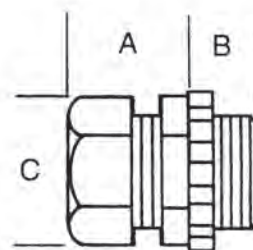

CATALOG NUMBER	TRADE SIZE	KO SIZE	DIM A	DIM B	DIM C	UNIT PACK	MASTER PACK	LBS. / 100 PCS.	UPC #
S1010	1/2"	1/2"	1.040	0.034	1.120	50	500	11	61007
S1011	3/4"	3/4"	1.040	0.043	1.390	25	250	17	61017
S1012	1"	1"	1.050	0.052	1.700	50	200	23	61027
S1013	1-1/4"	1-1/4"	1.270	0.062	2.050	25	100	41	61037
S1014	1-1/2"	1-1/2"	1.400	0.064	2.250	10	40	50	61047
S1015	2"	2"	1.520	0.066	2.780	5	20	67	61057
S1015D	2-1/2"	2-1/2"	2.510	0.083	3.600	-	12	177	61067
S1015E	3"	3"	2.540	0.083	4.260	-	12	234	61077
S1015E1	3-1/2"	3-1/2"	2.720	0.087	4.710	-	6	288	60187
S1015F	4"	4"	2.890	0.090	5.210	-	6	343	61097

Insulated Throat



TYPE S4061

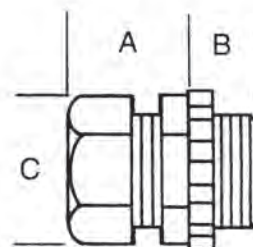

CATALOG NUMBER	TRADE SIZE	KO SIZE	DIM A	DIM B	DIM C	UNIT PACK	MASTER PACK	LBS. / 100 PCS.	UPC #
S4060	1/2"	1/2"	1.040	0.034	1.120	50	500	11	61003
S4061	3/4"	3/4"	1.040	0.043	1.390	25	250	17	61013
S4062	1"	1"	1.050	0.052	1.700	50	200	23	61023
S4063	1-1/4"	1-1/4"	1.270	0.062	2.050	25	100	41	61033
S4064	1-1/2"	1-1/2"	1.400	0.064	2.250	10	40	50	61043
S4065	2"	2"	1.520	0.066	2.780	5	20	67	61053
S4065D	2-1/2"	2-1/2"	2.510	0.083	3.600	-	12	177	61063
S4065E	3"	3"	2.540	0.083	4.200	-	12	234	61073
S4065E1	3-1/2"	3-1/2"	2.720	0.087	4.710	-	6	288	61083
S4065F	4"	4"	2.890	0.090	5.210	-	6	343	61093

STEEL EMT COMPRESSION COUPLINGS

FOR EMT CONDUIT

APPLICATION

To ground and secure E.M.T. raceway sections together.

FEATURES

- Concrete tight
- Heavy Steel Walls

STANDARD MATERIALS

Steel

STANDARD FINISH

Zinc Plated



TYPE S1017

CATALOG NUMBER	TRADE SIZE	DIM A	DIM B	UNIT PACK	MASTER PACK	LBS. / 100 PCS.	UPC #
S1016	1/2"	1.60	1.12	50	500	8	61107
S1017	3/4"	1.60	1.39	25	250	13	61117
S1018	1"	1.71	1.68	50	200	20	61127
S1019	1-1/4"	2.08	2.06	25	100	40	61137
S1020	1-1/2"	2.36	2.25	10	40	58	61147
S1021	2"	2.40	2.78	5	20	65	61157
S1021D	2-1/2"	3.89	3.65	-	12	130	61167
S1021E	3"	4.25	4.31	-	12	140	61177
S1021E1	3-1/2"	4.65	4.75	-	6	217	61187
S1021F	4"	4.90	5.27	-	6	250	61197

STEEL RAIN TIGHT EMT COMPRESSION CONNECTORS

FOR EMT CONDUIT

APPLICATION

Compression style connector with internal sealing ring and knockout gasket to create a raintight seal when connecting E.M.T. to box or enclosure.

FEATURES

- The only steel compression fitting, UL Listed Raintight
- Unique raised bump design affords fast, positive locking of compression nuts
- Male Hub Threads-NPSM
- Steel locknuts
- Heavy steel walls
- Raintight
- Concrete tight

STANDARD MATERIALS

Steel

STANDARD FINISH

Zinc Plated

PATENTED

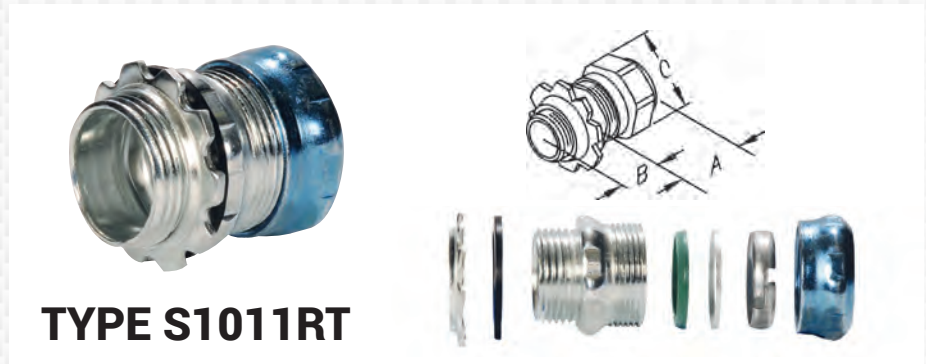

TYPE S1011RT

CATALOG NUMBER	TRADE SIZE	KO SIZE	DIM A	DIM B	DIM C	UNIT PACK	MASTER PACK	LBS. / 100 PCS.	UPC #
S1010RT	1/2"	1/2"	1.040	0.034	1.120	50	500	11	62201
S1011RT	3/4"	3/4"	1.040	0.043	1.390	25	250	17	62202
S1012RT	1"	1"	1.050	0.052	1.700	50	200	23	62203
S1013RT	1-1/4"	1-1/4"	1.270	0.062	2.050	25	100	41	62204
S1014RT	1-1/2"	1-1/2"	1.400	0.064	2.250	10	40	50	62205
S1015RT	2"	2"	1.520	0.066	2.780	5	20	67	62206
S1015DRT	2-1/2"	2-1/2"	2.510	0.083	3.600	-	12	177	62311
S1015ERT	3"	3"	2.540	0.083	4.260	-	12	234	62312
S1015E1RT	3-1/2"	3-1/2"	2.720	0.087	4.710	-	6	288	62313
S1015FRT	4"	4"	2.890	0.090	5.210	-	6	343	62314

Insulated Throat

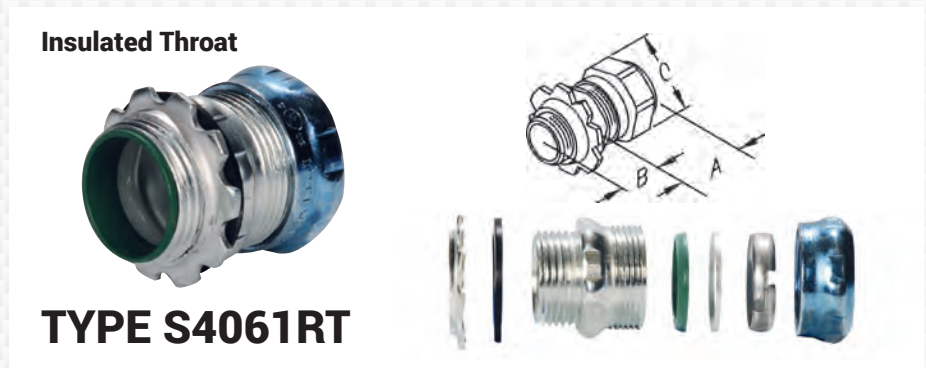

TYPE S4061RT

CATALOG NUMBER	TRADE SIZE	KO SIZE	DIM A	DIM B	DIM C	UNIT PACK	MASTER PACK	LBS. / 100 PCS.	UPC #
S4060RT	1/2"	1/2"	1.040	0.034	1.120	50	500	11	62301
S4061RT	3/4"	3/4"	1.040	0.043	1.390	25	250	17	62302
S4062RT	1"	1"	1.050	0.052	1.700	50	200	23	62303
S4063RT	1-1/4"	1-1/4"	1.270	0.062	2.050	25	100	41	62304
S4064RT	1-1/2"	1-1/2"	1.400	0.064	2.250	10	40	50	62305
S4065RT	2"	2"	1.520	0.066	2.780	5	20	67	62306
S4065DRT	2-1/2"	2-1/2"	2.510	0.083	3.600	-	12	177	62307
S4065ERT	3"	3"	2.540	0.083	4.260	-	12	234	62308
S4065E1RT	3-1/2"	3-1/2"	2.720	0.087	4.710	-	6	288	62309
S4065FRT	4"	4"	2.890	0.090	5.210	-	6	343	62310

STEEL RAIN TIGHT EMT COMPRESSION COUPLINGS

FOR EMT CONDUIT

APPLICATION

Compression style coupling used to join two lengths of E.M.T. Internal sealing rings create a raintight seal.

FEATURES

- The only steel compression fitting, UL Listed Raintight
- Unique raised bump design affords fast, positive locking of compression nuts
- Heavy steel walls
- Raintight
- Concrete tight

STANDARD MATERIALS

Steel

STANDARD FINISH

Zinc Plated

PATENTED

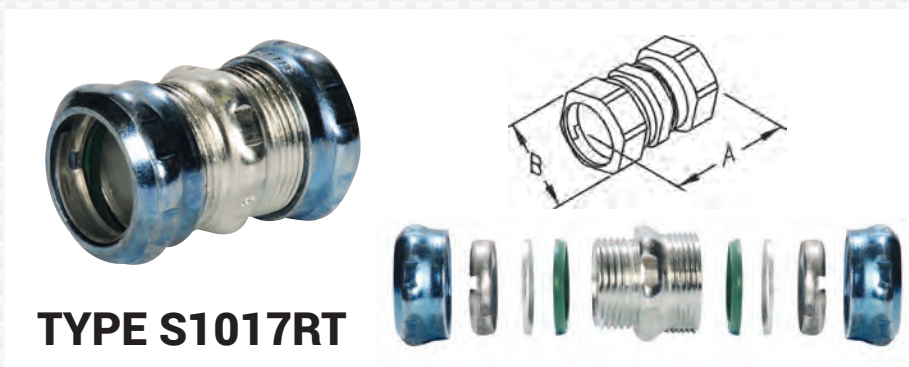

TYPE S1017RT

CATALOG NUMBER	TRADE SIZE	DIM A	DIM B	UNIT PACK	MASTER PACK	LBS. / 100 PCS.	UPC #
S1016RT	1/2"	1.60	1.12	50	500	8	62401
S1017RT	3/4"	1.60	1.39	25	250	13	62402
S1018RT	1"	1.71	1.68	50	200	20	62403
S1019RT	1-1/4"	2.08	2.06	25	100	40	62404
S1020RT	1-1/2"	2.36	2.25	10	40	58	62405
S1021RT	2"	2.40	2.78	5	20	65	62406
S1021DRT	2-1/2"	3.89	3.65	-	12	130	62407
S1021ERT	3"	4.25	4.31	-	12	140	62408
S1021E1RT	3-1/2"	4.65	4.75	-	6	217	62409
S1021FRT	4"	4.90	5.27	-	6	250	62410

ZINC EMT SET-SCREW CONNECTORS

FOR EMT CONDUIT

APPLICATION

To secure and terminate E.M.T. to knockouts in concrete tight box or dry location applications.

FEATURES

- Concrete tight
- Pre-set/pre-staked set-screws
- Combination head set-screws
- Male hub threads NPS

STANDARD MATERIALS

Zinc Die Cast



TYPE 1111

CATALOG NUMBER	TRADE SIZE	DIM A	DIM B	UNIT PACK	MASTER PACK	LBS. / 100 PCS.	UPC #
1110	1/2"	1.16	0.41	50	500	7	62002
1111	3/4"	1.31	0.47	25	250	10	62012
1112	1"	1.56	0.56	50	200	15	62022
*1112A	1-1/4"	1.96	0.63	25	100	29	62032
*1112B	1-1/2"	2.19	0.72	10	40	40	62042
*1112C	2"	2.50	0.75	5	20	54	62052
*1112D	2-1/2"	3.03	1.00	-	12	83	62062
*1112E	3"	3.37	1.06	-	12	100	62072
*1112E1	3-1/2"	3.58	1.09	-	10	128	62082
*1112F	4"	3.75	1.09	-	6	156	62092

*Furnished with two set-screws

Insulated Throat



TYPE 4067

CATALOG NUMBER	TRADE SIZE	DIM A	DIM B	UNIT PACK	MASTER PACK	LBS. / 100 PCS.	UPC #
4066	1/2"	1.16	0.41	50	500	7	62008
4067	3/4"	1.31	0.47	25	250	10	62018
4068	1"	1.56	0.56	50	200	15	62028
*4069	1-1/4"	1.96	0.63	25	100	29	62038
*4070	1-1/2"	2.19	0.72	10	40	40	62048
*4071	2"	2.50	0.75	5	20	54	62058
*4072	2-1/2"	3.03	1.00	-	12	83	62068
*4073	3"	3.37	1.06	-	12	100	62078
*4074	3-1/2"	3.58	1.09	-	10	128	62088
*4075	4"	3.75	1.09	-	6	156	62098

*Furnished with two set-screws

ZINC EMT SET-SCREW COUPLINGS

FOR EMT CONDUIT

APPLICATION

To ground and secure E.M.T. raceway sections together.

FEATURES

- Concrete tight
- Pre-set/Pre-staked set screws
- Three-way combination screws

STANDARD MATERIALS

Zinc Die Cast

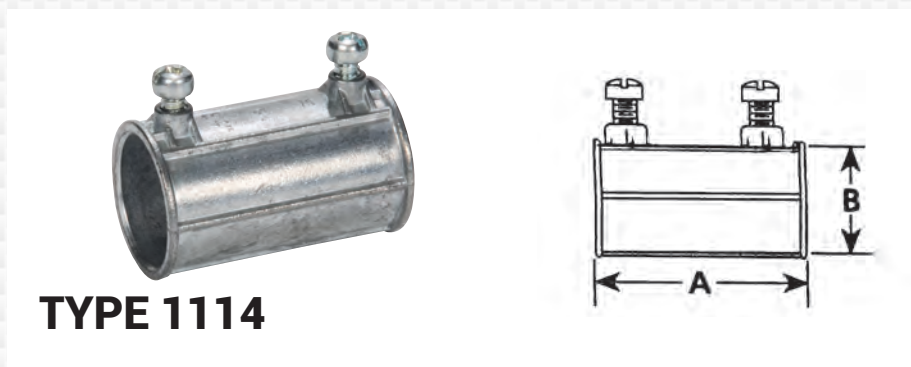

TYPE 1114



UL LISTED
E308075



CATALOG NUMBER	TRADE SIZE	DIM A	DIM B	UNIT PACK	MASTER PACK	LBS. / 100 PCS.	UPC #
1113	1/2"	1.53	0.94	50	500	8	62102
1114	3/4"	1.88	1.16	25	250	13	62112
1115	1"	2.00	1.43	50	200	20	62122
*1115A	1-1/4"	2.50	1.84	25	100	40	62132
*1115B	1-1/2"	2.88	2.07	10	40	58	62142
*1115C	2"	3.44	2.55	5	20	65	62152
*1115D	2-1/2"	3.99	3.30	-	12	130	62162
*1115E	3"	4.55	3.94	-	12	140	62172
*1115E1	3-1/2"	4.82	4.45	-	10	217	62182
*1115F	4"	5.24	4.97	-	6	250	62192

*Furnished with four set-screws

ZINC EMT COMPRESSION CONNECTORS

FOR EMT CONDUIT

APPLICATION

To secure and terminate E.M.T. to knockouts in concrete tight box, dry or damp location applications.

FEATURES

- Male hub threads NPS
- Concrete tight

STANDARD MATERIALS

Zinc Die Cast



UL LISTED
E308075



TYPE 1011

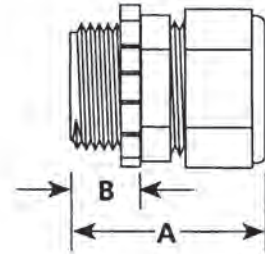

CATALOG NUMBER	TRADE SIZE	DIM A	DIM B	UNIT PACK	MASTER PACK	LBS. / 100 PCS.	UPC #
1010	1/2"	1.20	0.40	50	500	10	61002
1011	3/4"	1.27	0.40	25	250	14	61012
1012	1"	1.48	0.50	50	200	20	61022
1013	1-1/4"	1.75	0.59	25	100	37	61032
1014	1-1/2"	1.91	0.62	10	40	55	61042
1015	2"	2.11	0.76	5	20	81	61052
1015D	2-1/2"	2.62	1.00	-	12	107	61062
1015E	3"	2.75	1.06	-	12	137	61072
1015E1	3-1/2"	2.83	1.14	-	10	176	61082
1015F	4"	2.84	1.14	-	6	206	61092

Insulated Throat



TYPE 4061

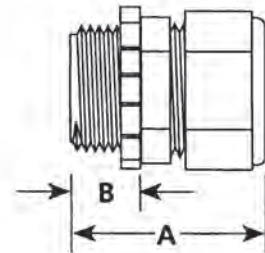

CATALOG NUMBER	TRADE SIZE	DIM A	DIM B	UNIT PACK	MASTER PACK	LBS. / 100 PCS.	UPC #
4060	1/2"	1.20	0.40	50	500	10	61008
4061	3/4"	1.27	0.40	25	250	14	61018
4062	1"	1.48	0.50	50	200	20	61028
4063	1-1/4"	1.75	0.59	25	100	37	61038
4064	1-1/2"	1.91	0.62	10	40	55	61048
4065	2"	2.11	0.76	5	20	81	61058
4065D	2-1/2"	2.62	1.00	-	12	107	61068
4065E	3"	2.75	1.06	-	12	137	61078
4065E1	3-1/2"	2.83	1.14	-	10	176	61088
4065F	4"	2.84	1.14	-	6	206	61098

ZINC EMT COMPRESSION COUPLINGS

FOR EMT CONDUIT

APPLICATION

To join lengths of E.M.T. for concrete tight, dry or damp location applications.

FEATURES

→ Concrete tight

STANDARD MATERIALS

Zinc Die Cast

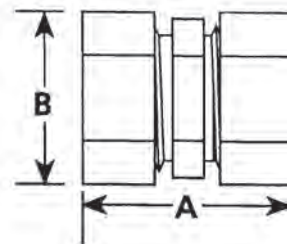

TYPE 1017

CATALOG NUMBER	TRADE SIZE	DIM A	DIM B	UNIT PACK	MASTER PACK	LBS. / 100 PCS.	UPC #
1016	1/2"	1.59	1.09	50	500	8	61102
1017	3/4"	1.81	1.28	25	250	13	61112
1018	1"	1.82	1.60	50	200	20	61122
1019	1-1/4"	2.07	2.00	25	100	40	61132
1020	1-1/2"	2.47	2.29	10	40	58	61142
1021	2"	2.56	2.79	5	20	65	61152
1021D	2-1/2"	3.29	3.51	-	12	130	61162
1021E	3"	3.42	4.21	-	12	140	61172
1021E1	3-1/2"	3.51	4.75	-	10	217	61182
1021F	4"	3.54	5.32	-	6	250	61192

COMBINATION COUPLINGS

FOR RIGID CONDUIT, IMC AND E.M.T.

APPLICATION

To join E.M.T. to Rigid or IMC

FEATURES

- Threaded rigid and IMC to compression E.M.T.
- Concrete tight
- NPT female hub

STANDARD MATERIALS

Steel

STANDARD FINISH

Zinc Plated



For EMT Steel Compression to Threaded Rigid Couplings

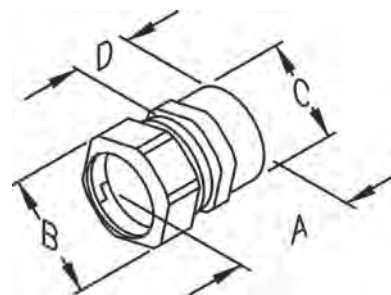

TYPE ERC-23

CATALOG NUMBER	TRADE SIZE	DIM A	DIM B	DIM C	DIM D	UNIT PACK	MASTER PACK	LBS. / 100 PCS.	UPC #
ERC-22	1/2"	1.313	1.125	0.875	0.688	25	250	14	47322
ERC-23	3/4"	1.438	1.375	1.125	0.750	25	250	25	47323
ERC-24	1"	1.500	1.688	1.375	0.813	25	250	34	47324

APPLICATION

A combination coupling to provide a transition from EMT to unthreaded rigid conduit or IMC.

FEATURES

- Pre-set and staked Robertson head screws
- Concrete tight when taped

STANDARD MATERIALS

Steel

STANDARD FINISH

Zinc Plated



For EMT Steel Set-Screw to RIGID Set-Screw Couplings

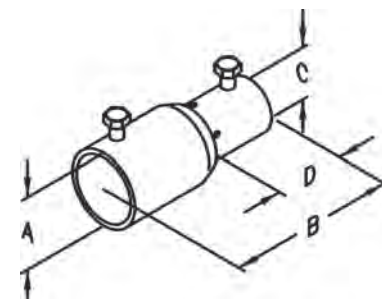

TYPE S18ES

CATALOG NUMBER	TRADE SIZE	DIM A	DIM B	DIM C	DIM D	UNIT PACK	MASTER PACK	LBS. / 100 PCS.	UPC #
S16ES	1/2"	1.000	2.375	0.875	0.938	50	500	14	23016
S17ES	3/4"	1.250	2.813	1.125	1.125	25	250	28	23017
S18ES	1"	1.500	3.000	1.188	1.188	-	25	36	23018

ZINC 90° PULL ELBOWS

FOR EMT CONDUIT

APPLICATION

90° corner pulling elbows are used to facilitate pulling conductors through a sharp bend in a run of E.M.T. The removable cover gives ample access so that wire pulling can be achieved without any obstructions.

FEATURES

- Removable aluminum cover

STANDARD MATERIALS

Zinc Die Cast



UL LISTED
E198258
CSA File No. LR57925



Female to Female



TYPE 1326

CATALOG NUMBER	TRADE SIZE	DIM A	DIM B	UNIT PACK	MASTER PACK	LBS. / 100 PCS.	UPC #
1326	1/2"	1.31	0.94	10	100	24	13262
1327	3/4"	1.59	1.22	5	50	37	13272
1328	1"	1.94	1.59	-	25	68	13282
1329	1-1/4"	2.36	1.97	-	20	102	13292

APPLICATION

Used to connect E.M.T. conduit to a metal box enclosure at a 90° bend.

FEATURES

- Removable aluminum cover
- Assembled with zinc die cast locknut

STANDARD MATERIALS

Zinc Die Cast



UL LISTED
E198258
CSA File No. LR57925



Male to Female

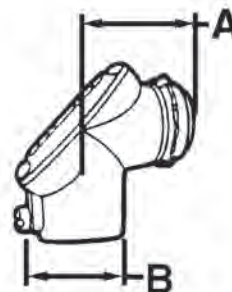

TYPE 1332

CATALOG NUMBER	TRADE SIZE	DIM A	DIM B	UNIT PACK	MASTER PACK	LBS. / 100 PCS.	UPC #
1332	1/2"	1.31	0.93	10	100	22	13322
1333	3/4"	1.47	1.22	5	50	35	13332

ZINC OFFSET CONNECTORS

FOR EMT CONDUIT

APPLICATION

Used to connect E.M.T. conduit to a metal outlet box or enclosure where an offset is desired.

FEATURES

- Set-Screw Type
- Concrete tight
- Assembled with zinc die cast locknut

STANDARD MATERIALS

Zinc Die Cast



UL LISTED
E198256
CSA File No. LR57925



Set-Screw

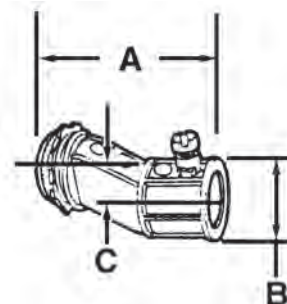

TYPE 1250

CATALOG NUMBER	TRADE SIZE	DIM A	DIM B	DIM C	UNIT PACK	MASTER PACK	LBS. / 100 PCS.	UPC #
1250	1/2"	2.090	0.940	0.375	10	100	12	61250
1251	3/4"	2.980	1.160	0.750	10	100	19	61251

APPLICATION

Used to connect E.M.T. conduit to a metal outlet box or enclosure where an offset is desired.

FEATURES

- Compression Type
- Raintight & Concrete tight
- Assembled with zinc die cast locknut

STANDARD MATERIALS

Zinc Die Cast



UL LISTED
E198256
CSA File No. LR57925



Compression

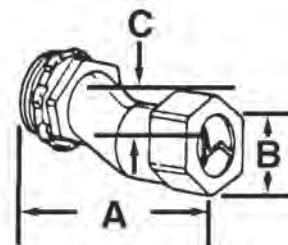

TYPE 1260

CATALOG NUMBER	TRADE SIZE	DIM A	DIM B	DIM C	UNIT PACK	MASTER PACK	LBS. / 100 PCS.	UPC #
1260	1/2"	2.130	1.000	0.375	20	200	13	13761
1261	3/4"	2.900	1.190	0.750	10	100	21	13702

EMT STRAPS

FOR EMT CONDUIT

APPLICATION

Click-on type one-hole straps for E.M.T. Provides support for the conduits, as required by the National Electrical Code.

STANDARD MATERIALS

Steel

STANDARD FINISH

Zinc Plated



One-Hole

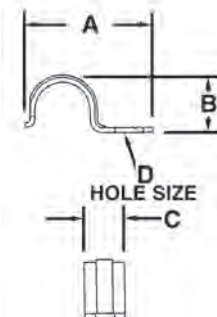

TYPE 143S

CATALOG NUMBER	TRADE SIZE	DIM A	DIM B	DIM C	DIM D	UNIT PACK	MASTER PACK	LBS. / 100 PCS.	UPC #
142S	1/2"	1.720	0.700	0.550	0.312	100	1000	2	81427
143S	3/4"	1.980	0.975	0.630	0.312	100	1000	3	81437
144S	1"	2.210	1.090	0.750	0.312	50	500	4	81447
145S	1-1/4"	2.880	1.540	0.880	0.355	50	500	10	81457
146S	1-1/2"	3.140	1.750	0.990	0.335	-	50	16	81467
147S	2"	3.890	2.150	1.110	0.450	-	50	22	81477
158S	2-1/2"	4.925	2.825	1.245	0.550	-	25	62	81587
159S	3"	5.540	3.430	1.250	0.550	-	25	76	81597
160S	3-1/2"	6.260	3.900	1.250	0.575	-	10	120	81607
161S	4"	6.830	4.390	1.240	0.575	-	10	125	81613

APPLICATION

Snap-on type two-hole straps for E.M.T. are used where higher load bearing supports are desired.

STANDARD MATERIALS

Steel

STANDARD FINISH

Zinc Plated



Two-Hole

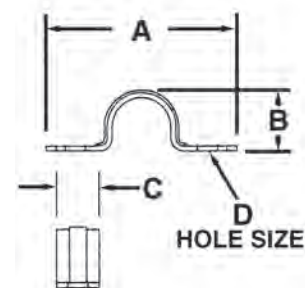

TYPE 2143S

CATALOG NUMBER	TRADE SIZE	DIM A	DIM B	DIM C	DIM D	UNIT PACK	MASTER PACK	LBS. / 100 PCS.	UPC #
2142S	1/2"	2.200	0.790	0.560	0.200	-	250	1	21427
2143S	3/4"	2.700	0.980	0.620	0.200	-	200	2	21437
2144S	1"	2.975	1.185	0.690	0.200	-	100	4	21447
2145S	1-1/4"	3.650	1.535	0.750	0.275	-	50	5	21457
2146S	1-1/2"	4.250	1.765	0.870	0.275	-	50	8	21467
2147S	2"	4.730	2.300	0.995	0.325	-	25	13	21477
2158S	2-1/2"	6.025	2.855	0.985	0.345	-	25	20	21533
2159S	3"	6.460	3.425	0.995	0.345	-	20	25	21597
2160S	3-1/2"	7.300	3.925	0.990	0.345	-	10	33	21535
2161S	4"	7.895	4.435	0.995	0.345	-	10	36	21617



Steel Electric
PRODUCTS

Ph: 718.259.6100 / 800.626.1223 Fax: 718.331.1874

www.sepco-usa.com

ZINC COMBINATION COUPLINGS

FOR EMT CONDUIT AND FLEXIBLE METALLIC CONDUIT

APPLICATION

A combination coupling to provide a transition from E.M.T. to flexible metallic conduit.

FEATURES

→ Assembled with tri-combo screws

STANDARD MATERIALS

Zinc Die Cast



UL LISTED
E198256
CSA File No. LR57925



TYPE 170C

CATALOG NUMBER	TRADE SIZE	DIM A	DIM B	UNIT PACK	MASTER PACK	LBS. / 100 PCS.	UPC #
*170C	1/2" E.M.T. - 3/8" Flex	1.280	1.140	50	500	8	51702
171C	1/2" E.M.T. - 1/2" Flex	1.645	1.340	25	250	10	51703
172C	3/4" E.M.T. - 3/4" Flex	1.975	1.535	20	200	15	51704
173C	1" E.M.T. - 1" Flex	2.285	1.700	10	100	26	51705

*EMT TO NM CABLE

APPLICATION

A combination coupling to provide a transition from E.M.T. to flexible metallic conduit.

FEATURES

→ Assembled with tri-combo screws

STANDARD MATERIALS

Zinc Die Cast



UL LISTED
E198256
CSA File No. LR57925

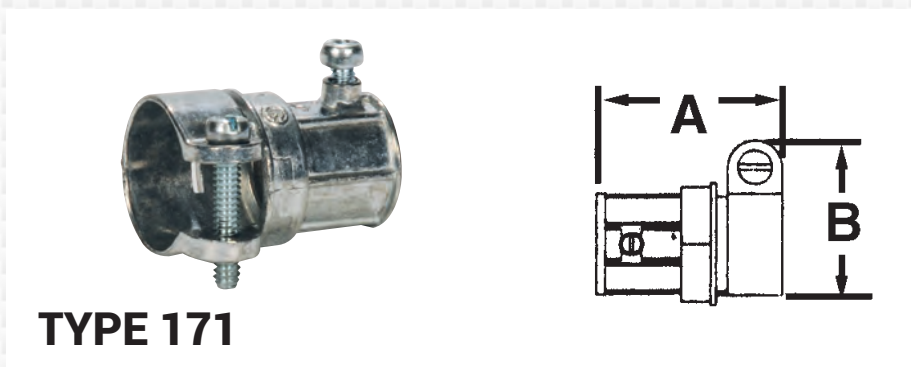

TYPE 171

CATALOG NUMBER	TRADE SIZE	DIM A	DIM B	UNIT PACK	MASTER PACK	LBS. / 100 PCS.	UPC #
171	1/2" E.M.T. - 1/2" FMC	1.645	1.340	25	250	10	51712
172	3/4" E.M.T. - 3/4" FMC	1.975	1.535	20	200	15	51722



LIQUIDTIGHT FITTINGS

Malleable Iron Straight Liquidtight Connectors.....	124	Malleable Iron/Mechanical Galvanized Straight Liquidtight Connectors.....	133
Malleable Iron 90° Liquidtight Connectors.....	125	Malleable Iron/Mechanical Galvanized 90° Liquidtight Connectors.....	134
Malleable Iron 45° Liquidtight Connectors.....	126	Malleable Iron/Mechanical Galvanized 45° Liquidtight Connectors.....	135
Malleable Iron Straight Liquidtight Connectors with Aluminum Lugs.....	127	Malleable Iron/Mechanical Galvanized Straight Liquidtight Connectors with Copper Lugs.....	136
Malleable Iron 90° Liquidtight Connectors with Aluminum Lugs.....	128	Malleable Iron/Mechanical Galvanized 90° Liquidtight Connectors with Copper Lugs.....	137
Malleable Iron 45° Liquidtight Connectors with Aluminum Lugs.....	129	Malleable Iron/Mechanical Galvanized 45° Liquidtight Connectors with Copper Lugs.....	138
Malleable Iron Straight Liquidtight Connectors with Copper Lugs.....	130	Zinc Straight Liquidtight Connectors.....	139
Malleable Iron 90° Liquidtight Connectors with Copper Lugs.....	131	Zinc 90° Liquidtight Connectors.....	140
Malleable Iron 45° Liquidtight Connectors with Copper Lugs.....	132		

MALLEABLE IRON STRAIGHT LIQUIDTIGHT CONNECTORS

FOR LIQUIDTIGHT FLEXIBLE METALLIC CONDUIT

APPLICATION

To secure, ground and seal Liquidtight Flexible Metal conduit, to boxes and enclosures

FEATURES

- Tapered threaded male hub NPT
- Compact, slim diameter with small turning radius
- Furnished with an insulated throat with steel locknut and sealing ring
- Liquidtight/Raintight/Concrete tight/Oiltight
- Suitable for wet locations
- Long ferrule prevents pullout and tight bend conduit "pop-out"
- UL Listed liquidtight flexible metal conduit fittings are suitable for use in the following Hazardous Locations under NEC 501-4(b), 502-4(a)(2); Class I, Div.2; Class II, Div. 1 and 2; and Class III, Div. 1 and 2 and are suitable for grounding in sizes 3/8" through 1-1/2" under NEC 351-I

STANDARD MATERIALS

Malleable Iron/Steel Ferrule

STANDARD FINISH

Zinc Plated



OPTIONAL FINISH

For additional corrosion protection, specify Mechanical Galvanized. Add suffix 'MG' to Malleable Iron catalog number. Example SLT27TMG. For more information, see page 16.

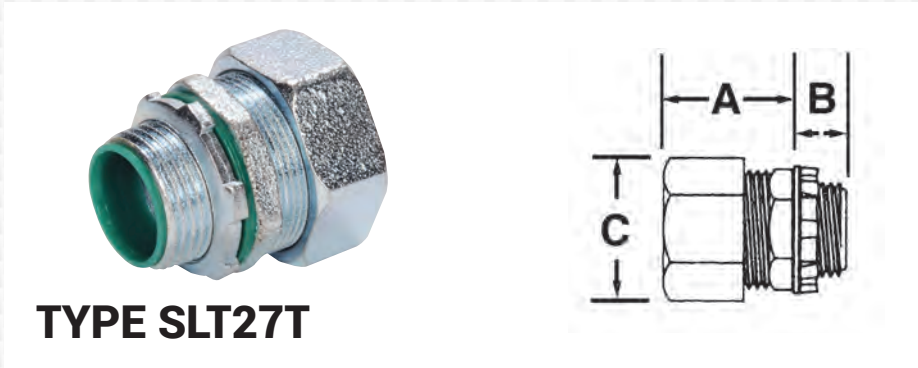

TYPE SLT27T

All Furnished with Insulated Throats

CATALOG NUMBER	TRADE SIZE	KO SIZE	I.D.	O.D.	DIM A	DIM B	DIM C	UNIT PACK	MASTER PACK	LBS./100 PCS.	UPC #
SLT47T	3/8"	1/2"	0.590	0.793	1.140	0.500	1.150	25	250	16	14419
SLT27T	1/2"	1/2"	0.590	0.793	1.250	0.500	1.280	25	250	18	14630
SLT28T	3/4"	3/4"	0.785	1.020	1.280	0.520	1.550	10	100	29	14640
SLT29T	1"	1"	0.980	1.261	1.430	0.650	1.800	5	50	40	14650
SLT30T	1-1/4"	1-1/4"	1.330	1.605	1.500	0.660	2.250	5	50	56	14309
SLT31T	1-1/2"	1-1/2"	1.530	1.844	1.610	0.730	2.440	10	50	71	14319
SLT32T	2"	2"	1.995	2.337	1.760	0.750	2.970	5	25	100	14329
SLT33T	2-1/2"	2-1/2"	2.341	2.797	2.180	1.010	4.010	1	10	367	14339
SLT34T	3"	3"	2.939	3.418	2.500	1.150	4.180	1	10	461	14349
SLT60T	3-1/2"	3-1/2"	3.406	3.915	2.610	1.180	5.250	1	10	675	14609
SLT61T	4"	4"	3.882	4.411	2.740	1.250	5.780	1	5	797	14619
SLT62T	5"	5"	391.77	460.78	3.125	1.500	6.063	-	1	1047	78062
SLT63T	6"	6"	484.65	570.18	3.375	1.563	7.500	-	1	1381	60001

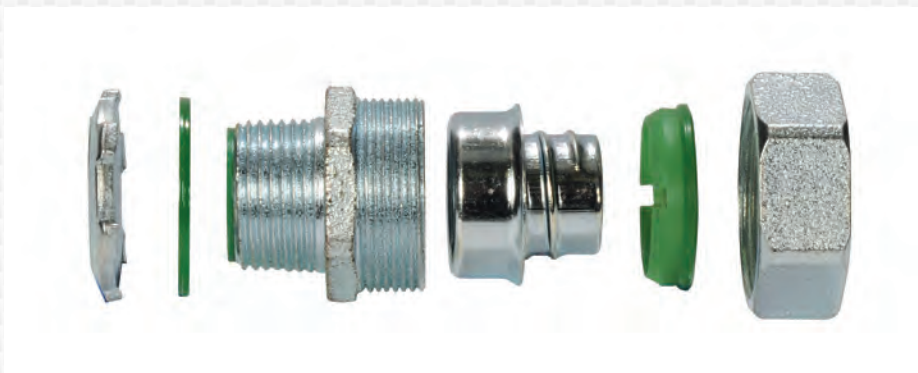

MALLEABLE IRON 90° LIQUIDTIGHT CONNECTORS

FOR LIQUIDTIGHT FLEXIBLE METALLIC CONDUIT

APPLICATION

To secure, ground seal Liquidtight Flexible Metal conduit, to boxes and enclosures

FEATURES

- Tapered threaded male hub NPT
- Compact, slim diameter with small turning radius
- Furnished with an insulated throat with steel locknut and sealing ring
- Liquidtight/Raintight/Concrete tight/Oiltight
- Suitable for wet locations
- Long ferrule prevents pullout and tight bend conduit "pop-out"
- UL Listed liquidtight flexible metal conduit fittings are suitable for use in the following Hazardous Locations under NEC 501-4(b), 502-4(a)(2); Class I, Div.2; Class II, Div. 1 and 2; and Class III, Div. 1 and 2 and are suitable for grounding in sizes 3/8" through 1-1/2" under NEC 351-I

STANDARD MATERIALS

Malleable Iron/Steel Ferrule

STANDARD FINISH

Zinc Plated



TYPE SLT35T

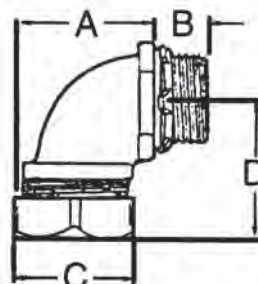

All Furnished with Insulated Throats

CATALOG NUMBER	TRADE SIZE	KO SIZE	I.D.	O.D.	DIM A	DIM B	DIM C	DIM D	UNIT PACK	MASTER PACK	LBS./100 PCS.	UPC #
SLT25T	3/8"	1/2"	0.590	0.793	1.31	0.50	1.15	1.37	10	100	28	14259
SLT35T	1/2"	1/2"	0.590	0.793	1.43	0.50	1.28	1.37	10	100	31	14690
SLT36T	3/4"	3/4"	0.785	1.020	1.62	0.52	1.55	1.50	10	100	46	14700
SLT37T	1"	1"	0.980	1.261	1.93	0.65	1.80	1.81	5	50	77	14710
SLT38T	1-1/4"	1-1/4"	1.330	1.605	2.37	0.66	2.25	1.94	-	10	98	14389
SLT39T	1-1/2"	1-1/2"	1.530	1.844	2.68	0.73	2.44	2.40	-	10	124	14399
SLT40T	2"	2"	1.995	2.337	3.18	0.75	2.97	2.64	-	5	179	14409
SLT65T	2-1/2"	2-1/2"	2.341	2.797	8.31	1.01	4.01	7.81	-	1	847	14659
SLT66T	3"	3"	2.939	3.418	9.80	1.15	4.18	9.15	-	1	1243	14669
SLT67T	3-1/2"	3-1/2"	3.406	3.915	11.18	1.18	5.25	11.22	-	1	1914	14679
SLT68T	4"	4"	3.882	4.411	12.98	1.25	5.78	12.54	-	1	2399	14689

OPTIONAL FINISH

For additional corrosion protection, specify Mechanical Galvanized. Add suffix 'MG' to Malleable Iron catalog number. Example SLT35TMG. For more information, see page 17.



MALLEABLE IRON 45° LIQUIDTIGHT CONNECTORS

FOR LIQUIDTIGHT FLEXIBLE METALLIC CONDUIT

APPLICATION

To secure, ground and seal Liquidtight Flexible Metal conduit to boxes and enclosures.

FEATURES

- Tapered threaded male hub NPT
- Compact, slim diameter with small turning radius
- Furnished with an insulated throat with steel locknut and sealing ring
- Liquidtight/Raintight/Concrete tight/Oiltight
- Suitable for wet locations
- Long ferrule prevents pullout and tight bend conduit "pop-out"
- UL Listed liquidtight flexible metal conduit fittings are suitable for use in the following Hazardous Locations under NEC 501-4(b), 502-4(a)(2); Class I, Div.2; Class II, Div. 1 and 2; and Class III, Div. 1 and 2 and are suitable for grounding in sizes 3/8" through 1-1/2" under NEC 351-I

STANDARD MATERIALS

Malleable Iron/Steel Ferrule

STANDARD FINISH

Zinc Plated



TYPE SLT35-45T

All Furnished with Insulated Throats

CATALOG NUMBER	TRADE SIZE	KO SIZE	I.D.	O.D.	DIM A	DIM B	DIM C	DIM D	UNIT PACK	MASTER PACK	LBS./100 PCS.	UPC #
SLT25-45T	3/8"	1/2"	0.590	0.793	1.14	0.50	1.15	1.48	10	100	29	14825
SLT35-45T	1/2"	1/2"	0.590	0.793	1.25	0.50	1.28	1.51	10	100	29	14835
SLT36-45T	3/4"	3/4"	0.785	1.020	1.28	0.52	1.55	1.54	10	100	42	14836
SLT37-45T	1"	1"	0.980	1.261	1.43	0.65	1.80	1.81	5	50	66	14837
SLT38-45T	1-1/4"	1-1/4"	1.330	1.605	1.50	0.66	2.25	2.16	-	10	90	14838
SLT39-45T	1-1/2"	1-1/2"	1.530	1.844	1.61	0.73	2.44	2.43	-	10	112	14839
SLT40-45T	2"	2"	1.995	2.337	1.76	0.75	2.97	2.82	-	5	179	14840
SLT65-45T	2-1/2"	2-1/2"	2.341	2.797	2.18	1.01	4.01	4.41	-	1	582	14865
SLT66-45T	3"	3"	2.939	3.418	2.50	1.15	4.18	5.50	-	1	869	14866
SLT67-45T	3-1/2"	3-1/2"	3.406	3.915	2.61	1.18	5.25	5.93	-	1	1296	14867
SLT68-45T	4"	4"	3.882	4.411	2.74	1.25	5.78	8.34	-	1	1539	14868

OPTIONAL FINISH

For additional corrosion protection, specify Mechanical Galvanized. Add suffix 'MG' to Malleable Iron catalog number. Example SLT35-45TMG. For more information, see page 18.



MALLEABLE IRON STRAIGHT LIQUIDTIGHT CONNECTORS

WITH ALUMINUM LUGS FOR LIQUIDTIGHT FLEXIBLE METALLIC CONDUIT

APPLICATION

Connects conduit and terminates bonding conductor run externally across liquidtight conduit.

FEATURES

- Tapered threaded male hub NPT
- Compact, slim diameter with small turning radius
- Furnished with Insulated throat, steel locknut, and sealing ring
- Liquidtight/Raintight/Concrete tight/Oiltight
- Suitable for grounding & wet locations
- Long ferrule prevents pullout and tight bend conduit 'pop-out'
- UL Listed liquidtight flexible metal conduit fittings are suitable for use in the following Hazardous Locations under NEC 501-4(b), 502-4(a)(2); Class I, Div.2; Class II, Div. 1 and 2; and Class III, Div. 1 and 2 and are suitable for grounding in sizes 3/8" through 1-1/2" under NEC 351-I

STANDARD MATERIALS

Malleable Iron/Steel Ferrule/
Aluminum Grounding Lug

STANDARD FINISH

Zinc Plated



TYPE SLT27ALT

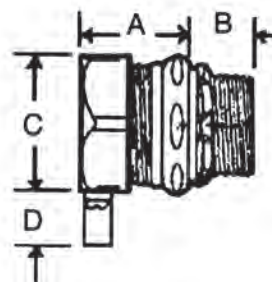

All Furnished with Insulated Throats

CATALOG NUMBER	TRADE SIZE	LUG SIZE	I.D.	O.D.	DIM A	DIM B	DIM C	DIM D	UNIT PACK	MASTER PACK	LBS. / 100 PCS.	UPC #
SLT47ALT	3/8"	#4-#14	0.590	0.793	1.14	0.50	1.15	0.75	25	250	18	50000
SLT27ALT	1/2"	#4-#14	0.590	0.793	1.25	0.50	1.28	0.75	25	250	20	50001
SLT28ALT	3/4"	#4-#14	0.785	1.020	1.28	0.52	1.55	0.75	10	100	31	50002
SLT29ALT	1"	#4-#14	0.980	1.261	1.43	0.65	1.80	0.75	5	50	42	50003
SLT30ALT	1-1/4"	#4-#14	1.330	1.605	1.50	0.66	2.25	0.75	5	50	57	50004
SLT31ALT	1-1/2"	#4-#14	1.530	1.844	1.61	0.73	2.44	0.75	10	50	73	50005
SLT32ALT	2"	#4-#14	1.995	2.337	1.76	0.75	2.97	0.75	5	25	101	50006
SLT33ALT	2-1/2"	#1/0-#8	2.341	2.797	2.18	1.01	4.01	1.13	1	10	373	50007
SLT34ALT	3"	#1/0-#8	2.939	3.418	2.50	1.15	4.18	1.13	1	10	465	50008
SLT60ALT	3-1/2"	#3/0-#6	3.406	3.915	2.61	1.18	5.25	1.50	1	10	686	50009
SLT61ALT	4"	#3/0-#6	3.882	4.411	2.74	1.25	5.78	1.50	1	5	807	50010
SLT62ALT	5"	#6-#250MCM	391.77	460.78	3.13	1.50	6.06	1.69	-	1	1058	50011
SLT63ALT	6"	#6-#250MCM	484.65	570.18	3.13	1.56	7.50	1.69	-	1	1395	50012

Also available with copper lugs. See page 130.



MALLEABLE IRON 90° LIQUIDTIGHT CONNECTORS

WITH ALUMINUM LUGS FOR LIQUIDTIGHT FLEXIBLE METALLIC CONDUIT

APPLICATION

Connects conduit and terminates bonding conductor run externally across liquidtight conduit.

FEATURES

- Tapered threaded male hub NPT
- Compact, slim diameter with small turning radius
- Furnished with Insulated throat, steel locknut, and sealing ring
- Liquidtight/Raintight/Concrete tight/Oiltight
- Suitable for grounding and wet locations
- Long ferrule prevents pullout and tight bend conduit 'pop-out'
- UL Listed liquidtight flexible metal conduit fittings are suitable for use in the following Hazardous Locations under NEC 501-4(b), 502-4(a)(2); Class I, Div.2; Class II, Div. 1 and 2; and Class III, Div. 1 and 2 and are suitable for grounding in sizes 3/8" through 1-1/2" under NEC 351-I

STANDARD MATERIALS

Malleable Iron/Steel Ferrule/
Aluminum Grounding Lug

STANDARD FINISH

Zinc Plated

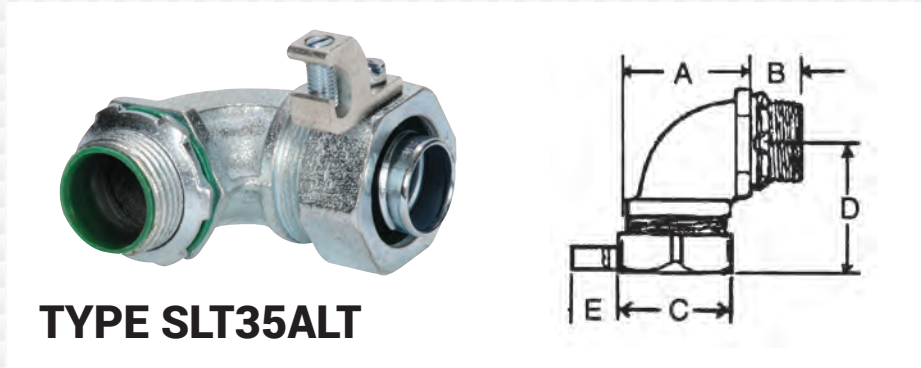

TYPE SLT35ALT

All Furnished with Insulated Throats

CATALOG NUMBER	TRADE SIZE	LUG SIZE	I.D.	O.D.	DIM A	DIM B	DIM C	DIM D	DIM E	UNIT PACK	MASTER PACK	LBS./100 PCS.	UPC #
SLT25ALT	3/8"	#4-#14	0.590	0.793	1.31	0.50	1.15	1.37	0.75	10	100	18	50013
SLT35ALT	1/2"	#4-#14	0.590	0.793	1.43	0.50	1.28	1.37	0.75	10	100	20	50014
SLT36ALT	3/4"	#4-#14	0.785	1.020	1.62	0.52	1.55	1.50	0.75	10	100	31	50015
SLT37ALT	1"	#4-#14	0.980	1.261	1.93	0.65	1.80	1.81	0.75	5	50	42	50016
SLT38ALT	1-1/4"	#4-#14	1.330	1.605	2.37	0.66	2.25	1.94	0.75	-	10	57	50017
SLT39ALT	1-1/2"	#4-#14	1.530	1.844	2.68	0.73	2.44	2.40	0.75	-	10	73	50018
SLT40ALT	2"	#4-#14	1.995	2.337	3.18	0.75	2.97	2.64	0.75	-	5	101	50019
SLT65ALT	2-1/2"	#1/0-#8	2.341	2.797	8.31	1.01	4.01	7.81	1.13	-	1	373	50020
SLT66ALT	3"	#1/0-#8	2.939	3.418	9.80	1.15	4.18	9.15	1.13	-	1	465	50021
SLT67ALT	3-1/2"	#3/0-#6	3.406	3.915	11.18	1.18	5.25	11.22	1.50	-	1	686	50022
SLT68ALT	4"	#3/0-#6	3.882	4.411	12.93	1.25	5.78	12.54	1.50	-	1	807	50023

Also available with copper lugs. See page 131.



MALLEABLE IRON 45° LIQUIDTIGHT CONNECTORS

WITH ALUMINUM LUGS FOR LIQUIDTIGHT FLEXIBLE METALLIC CONDUIT

APPLICATION

Connects conduit and terminates bonding conductor run externally across liquidtight conduit.

FEATURES

- Tapered threaded male hub NPT
- Compact, slim diameter with small turning radius
- Furnished with Insulated throat, steel locknut, and sealing ring
- Liquidtight/Raintight/Concrete tight/Oiltight
- Suitable for grounding
- Long ferrule prevents pull-out and tight bend conduit "pop-out"
- UL Listed liquidtight flexible metal conduit fittings are suitable for use in the following Hazardous Locations under NEC 501-4(b), 502-4(a)(2); Class I, Div.2; Class II, Div. 1 and 2; and Class III, Div. 1 and 2 and are suitable for grounding in sizes 3/8" through 1-1/2" under NEC 351-I.

STANDARD MATERIALS

Malleable Iron/Steel Ferrule/
Aluminum Grounding Lug

STANDARD FINISH

Zinc Plated

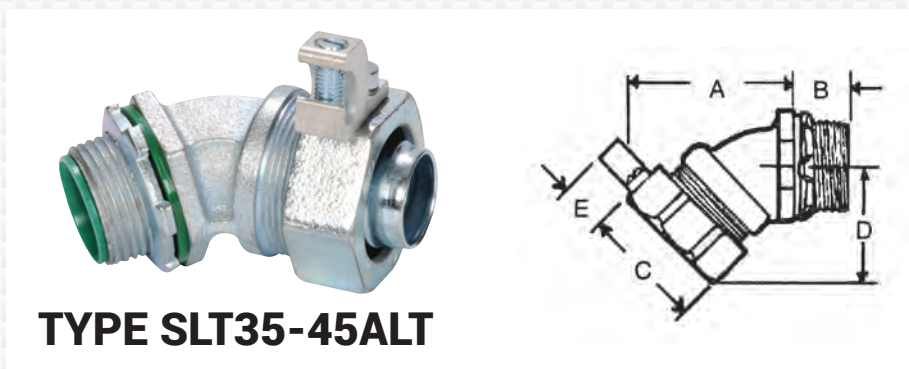

All Furnished with Insulated Throats

CATALOG NUMBER	TRADE SIZE	LUG SIZE	I.D.	O.D.	DIM A	DIM B	DIM C	DIM D	DIM E	UNIT PACK	MASTER PACK	LBS. / 100 PCS.	UPC #
SLT25-45ALT	3/8"	#4-#14	0.590	0.793	1.62	0.50	1.15	1.48	0.75	10	100	18	50024
SLT35-45ALT	1/2"	#4-#14	0.590	0.793	1.64	0.50	1.28	1.51	0.75	10	100	20	50025
SLT36-45ALT	3/4"	#4-#14	0.785	1.020	1.68	0.52	1.55	1.54	0.75	10	100	31	50026
SLT37-45ALT	1"	#4-#14	0.980	1.261	2.16	0.65	1.80	1.81	0.75	5	50	42	50027
SLT38-45ALT	1-1/4"	#4-#14	1.330	1.605	2.50	0.66	2.25	2.16	0.75	-	10	57	50028
SLT39-45ALT	1-1/2"	#4-#14	1.530	1.844	3.10	0.73	2.44	2.43	0.75	-	10	73	50029
SLT40-45ALT	2"	#4-#14	1.995	2.337	3.28	0.75	2.97	2.82	0.75	-	5	101	50030
SLT65-45ALT	2-1/2"	#1/0-#8	2.341	2.797	6.67	1.01	4.01	4.41	1.13	-	1	373	50031
SLT66-45ALT	3"	#1/0-#8	2.939	3.418	8.01	1.15	4.18	5.50	1.13	-	1	465	50032
SLT67-45ALT	3-1/2"	#3/0-#6	3.406	3.915	9.55	1.18	5.25	5.93	1.50	-	1	686	50033
SLT68-45ALT	4"	#3/0-#6	3.882	4.411	10.64	1.25	5.78	8.34	1.50	-	1	807	50034

Also available with copper lugs. See page 132.



MALLEABLE IRON STRAIGHT LIQUIDTIGHT CONNECTORS

WITH COPPER LUGS FOR LIQUIDTIGHT FLEXIBLE METALLIC CONDUIT

APPLICATION

Connects conduit and terminates bonding conductor run externally across liquidtight conduit.

FEATURES

- Tapered threaded male hub NPT
- Compact, slim diameter with small turning radius
- Furnished with Insulated throat, steel locknut, and sealing ring
- Liquidtight/Raintight/Concrete tight/Oiltight
- Suitable for grounding & wet locations
- Long ferrule prevents pullout and tight bend conduit 'pop-out'
- UL Listed liquidtight flexible metal conduit fittings are suitable for use in the following Hazardous Locations under NEC 501-4(b), 502-4(a)(2); Class I, Div.2; Class II, Div. 1 and 2; and Class III, Div. 1 and 2 and are suitable for grounding in sizes 3/8" through 1-1/2" under NEC 351-I

STANDARD MATERIALS

Malleable Iron/Steel Ferrule/
Copper Grounding Lug

STANDARD FINISH

Zinc Plated/Natural



OPTIONAL FINISH

For additional corrosion protection, specify Mechanical Galvanized. Add suffix 'MG' to Malleable Iron catalog number. Example SLT27CLTMG. For more information, see page 19.

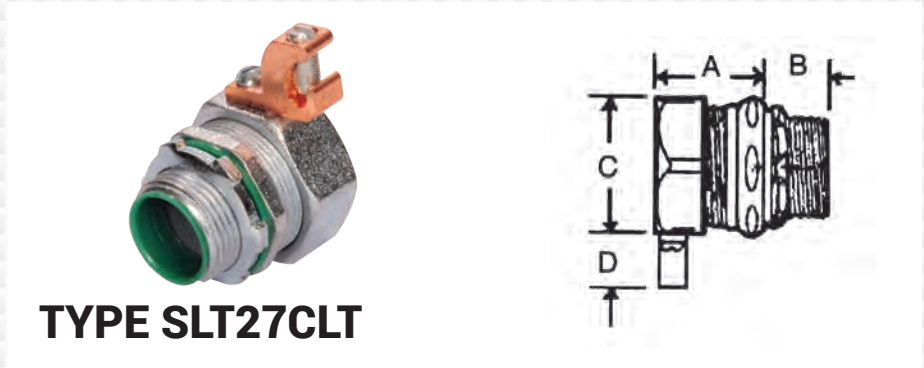

TYPE SLT27CLT

All Furnished with Insulated Throats

CATALOG NUMBER	TRADE SIZE	LUG SIZE	I.D.	O.D.	DIM A	DIM B	DIM C	DIM D	UNIT PACK	MASTER PACK	LBS./100 PCS.	UPC #
SLT47CLT	3/8"	#4-#14	0.590	0.793	1.14	0.50	1.15	0.75	25	250	18	50000
SLT27CLT	1/2"	#4-#14	0.590	0.793	1.25	0.50	1.28	0.75	25	250	20	50001
SLT28CLT	3/4"	#4-#14	0.785	1.020	1.28	0.52	1.55	0.75	10	100	31	50002
SLT29CLT	1"	#4-#14	0.980	1.261	1.43	0.65	1.80	0.75	5	50	42	50003
SLT30CLT	1-1/4"	#4-#14	1.330	1.605	1.50	0.66	2.25	0.75	5	50	57	50004
SLT31CLT	1-1/2"	#4-#14	1.530	1.844	1.61	0.73	2.44	0.75	10	50	73	50005
SLT32CLT	2"	#4-#14	1.995	2.337	1.76	0.75	2.97	0.75	5	25	101	50006
SLT33CLT	2-1/2"	#1/0-#8	2.341	2.797	2.18	1.01	4.01	1.13	1	10	373	50007
SLT34CLT	3"	#1/0-#8	2.939	3.418	2.50	1.15	4.18	1.13	1	10	465	50008
SLT60CLT	3-1/2"	#3/0-#6	3.406	3.915	2.61	1.18	5.25	1.50	1	10	686	50009
SLT61CLT	4"	#3/0-#6	3.882	4.411	2.74	1.25	5.78	1.50	1	5	807	50010
SLT62CLT	5"	#6-#250MCM	391.77	460.78	3.13	1.50	6.06	1.69	-	1	1058	50011
SLT63CLT	6"	#6-#250MCM	484.65	570.18	3.13	1.56	7.50	1.69	-	1	1395	50012

Also available with aluminum lugs. See page 127.



MALLEABLE IRON 90° LIQUIDTIGHT CONNECTORS

WITH COPPER LUGS FOR LIQUIDTIGHT FLEXIBLE METALLIC CONDUIT

APPLICATION

Connects conduit and terminates bonding conductor run externally across liquidtight conduit.

FEATURES

- Tapered threaded male hub NPT
- Compact, slim diameter with small turning radius
- Furnished with Insulated throat, steel locknut, and sealing ring
- Liquidtight/Raintight/Concrete tight/Oiltight
- Suitable for grounding and wet locations
- Long ferrule prevents pullout and tight bend conduit 'pop-out'
- UL Listed liquidtight flexible metal conduit fittings are suitable for use in the following Hazardous Locations under NEC 501-4(b), 502-4(a)(2); Class I, Div.2; Class II, Div. 1 and 2; and Class III, Div. 1 and 2 and are suitable for grounding in sizes 3/8" through 1-1/2" under NEC 351-I

STANDARD MATERIALS

Malleable Iron/Steel Ferrule/
Copper Grounding Lug

STANDARD FINISH

Zinc Plated/Natural



OPTIONAL FINISH

For additional corrosion protection, specify Mechanical Galvanized. Add suffix 'MG' to Malleable Iron catalog number. Example SLT35CLTMG. For more information, see page 20.

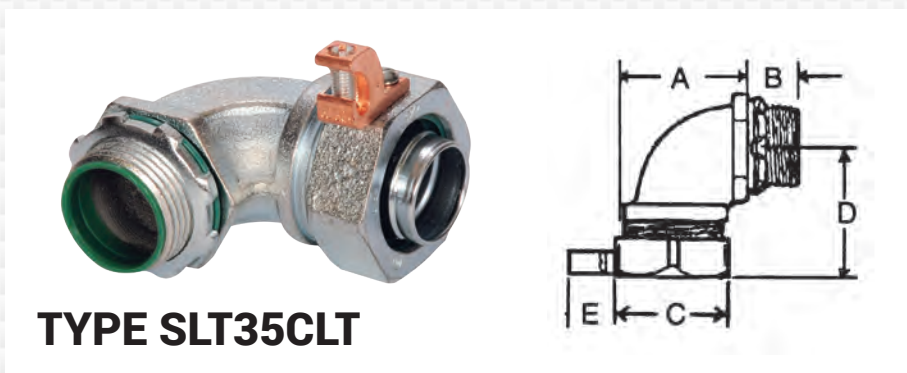

TYPE SLT35CLT

All Furnished with Insulated Throats

CATALOG NUMBER	TRADE SIZE	LUG SIZE	I.D.	O.D.	DIM A	DIM B	DIM C	DIM D	DIM E	UNIT PACK	MASTER PACK	LBS. / 100 PCS.	UPC #
SLT25CLT	3/8"	#4-#14	0.590	0.793	1.31	0.50	1.15	1.37	0.75	10	100	18	50013
SLT35CLT	1/2"	#4-#14	0.590	0.793	1.43	0.50	1.28	1.37	0.75	10	100	20	50014
SLT36CLT	3/4"	#4-#14	0.785	1.020	1.62	0.52	1.55	1.50	0.75	10	100	31	50015
SLT37CLT	1"	#4-#14	0.980	1.261	1.93	0.65	1.80	1.81	0.75	5	50	42	50016
SLT38CLT	1-1/4"	#4-#14	1.330	1.605	2.37	0.66	2.25	1.94	0.75	-	10	57	50017
SLT39CLT	1-1/2"	#4-#14	1.530	1.844	2.68	0.73	2.44	2.40	0.75	-	10	73	50018
SLT40CLT	2"	#4-#14	1.995	2.337	3.18	0.75	2.97	2.64	0.75	-	5	101	50019
SLT65CLT	2-1/2"	#1/0-#8	2.341	2.797	8.31	1.01	4.01	7.81	1.13	-	1	373	50020
SLT66CLT	3"	#1/0-#8	2.939	3.418	9.80	1.15	4.18	9.15	1.13	-	1	465	50021
SLT67CLT	3-1/2"	#3/0-#6	3.406	3.915	11.18	1.18	5.25	11.22	1.50	-	1	686	50022
SLT68CLT	4"	#3/0-#6	3.882	4.411	12.93	1.25	5.78	12.54	1.50	-	1	807	50023

Also available with aluminum lugs. See page 128.



MALLEABLE IRON 45° LIQUIDTIGHT CONNECTORS

WITH COPPER LUGS FOR LIQUIDTIGHT FLEXIBLE METALLIC CONDUIT

APPLICATION

Connects conduit and terminates bonding conductor run externally across liquidtight conduit.

FEATURES

- Tapered threaded male hub NPT
- Compact, slim diameter with small turning radius
- Furnished with Insulated throat, steel locknut, and sealing ring
- Liquidtight/Raintight/Concrete tight/Oiltight
- Suitable for grounding
- Long ferrule prevents pull-out and tight bend conduit "pop-out"
- UL Listed liquidtight flexible metal conduit fittings are suitable for use in the following Hazardous Locations under NEC 501-4(b), 502-4(a)(2); Class I, Div.2; Class II, Div. 1 and 2; and Class III, Div. 1 and 2 and are suitable for grounding in sizes 3/8" through 1-1/2" under NEC 351-I.

STANDARD MATERIALS

Malleable Iron/Steel Ferrule/
Copper Grounding Lug

STANDARD FINISH

Zinc Plated/Natural



OPTIONAL FINISH

For additional corrosion protection, specify Mechanical Galvanized. Add suffix 'MG' to Malleable Iron catalog number. Example SLT35-45CLTMG. For more information, see page 21.

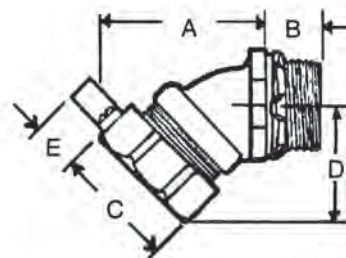
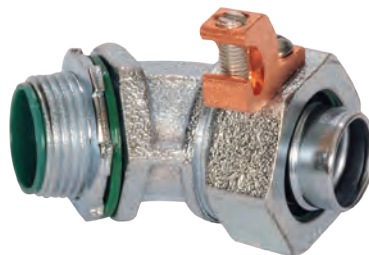

TYPE SLT35-45CLT

All Furnished with Insulated Throats

CATALOG NUMBER	TRADE SIZE	LUG SIZE	I.D.	O.D.	DIM A	DIM B	DIM C	DIM D	DIM E	UNIT PACK	MASTER PACK	LBS./100 PCS.	UPC #
SLT25-45CLT	3/8"	#4-#14	0.590	0.793	1.62	0.50	1.15	1.48	0.75	10	100	18	50024
SLT35-45CLT	1/2"	#4-#14	0.590	0.793	1.64	0.50	1.28	1.51	0.75	10	100	20	50025
SLT36-45CLT	3/4"	#4-#14	0.785	1.020	1.68	0.52	1.55	1.54	0.75	10	100	31	50026
SLT37-45CLT	1"	#4-#14	0.980	1.261	2.16	0.65	1.80	1.81	0.75	5	50	42	50027
SLT38-45CLT	1-1/4"	#4-#14	1.330	1.605	2.50	0.66	2.25	2.16	0.75	-	10	57	50028
SLT39-45CLT	1-1/2"	#4-#14	1.530	1.844	3.10	0.73	2.44	2.43	0.75	-	10	73	50029
SLT40-45CLT	2"	#4-#14	1.995	2.337	3.28	0.75	2.97	2.82	0.75	-	5	101	50030
SLT65-45CLT	2-1/2"	#1/0-#8	2.341	2.797	6.67	1.01	4.01	4.41	1.13	-	1	373	50031
SLT66-45CLT	3"	#1/0-#8	2.939	3.418	8.01	1.15	4.18	5.50	1.13	-	1	465	50032
SLT67-45CLT	3-1/2"	#3/0-#6	3.406	3.915	9.55	1.18	5.25	5.93	1.50	-	1	686	50033
SLT68-45CLT	4"	#3/0-#6	3.882	4.411	10.64	1.25	5.78	8.34	1.50	-	1	807	50034

Also available with aluminum lugs. See page 129.



MALLEABLE IRON/**MECHANICAL GALVANIZED** STRAIGHT LIQUIDTIGHT CONNECTORS

FOR LIQUIDTIGHT FLEXIBLE METALLIC CONDUIT

APPLICATION

To secure, ground and seal Liquidtight Flexible Metal conduit, to boxes and enclosures

FEATURES

- Tapered threaded male hub NPT
- Compact, slim diameter with small turning radius
- Furnished with an insulated throat with steel locknut and sealing ring
- Liquidtight/Raintight/Oiltight
- Suitable for wet locations
- Long ferrule prevents pullout and tight bend conduit "pop-out"
- UL Listed liquidtight flexible metal conduit fittings are suitable for use in the following Hazardous Locations under NEC 501-4(b), 502-4(a)(2); Class I, Div.2; Class II, Div. 1 and 2; and Class III, Div. 1 and 2 and are suitable for grounding in sizes 3/8" through 1-1/2" under NEC 351-I

STANDARD MATERIALS

Malleable Iron/Steel Ferrule

STANDARD FINISH

Sizes 1/2" - 4" - Mechanical Galvanized
Sizes 5" & 6" - Hot Dipped Galvanized



New
Product

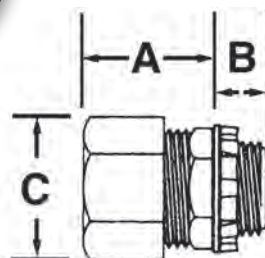

TYPE SLT27TMG

All Furnished with Insulated Throats

CATALOG NUMBER	TRADE SIZE	KO SIZE	I.D.	O.D.	DIM A	DIM B	DIM C	UNIT PACK	MASTER PACK	LBS. / 100 PCS.	UPC #
SLT27TMG	1/2"	1/2"	0.590	0.793	1.250	0.500	1.280	25	250	18	16305
SLT28TMG	3/4"	3/4"	0.785	1.020	1.280	0.520	1.550	10	100	29	16310
SLT29TMG	1"	1"	0.980	1.261	1.430	0.650	1.800	5	50	40	16315
SLT30TMG	1-1/4"	1-1/4"	1.330	1.605	1.500	0.660	2.250	5	50	56	16320
SLT31TMG	1-1/2"	1-1/2"	1.530	1.844	1.610	0.730	2.440	10	50	71	16325
SLT32TMG	2"	2"	1.995	2.337	1.760	0.750	2.970	5	25	100	16330
SLT33TMG	2-1/2"	2-1/2"	2.341	2.797	2.180	1.010	4.010	1	10	367	16335
SLT34TMG	3"	3"	2.939	3.418	2.500	1.150	4.180	1	10	461	16340
SLT60TMG	3-1/2"	3-1/2"	3.406	3.915	2.610	1.180	5.250	1	10	675	16345
SLT61TMG	4"	4"	3.882	4.411	2.740	1.250	5.780	1	5	797	16350
*SLT62TG	5"	5"	391.77	460.78	3.125	1.500	6.063	-	1	1047	16355
*SLT63TG	6"	6"	484.65	570.18	3.375	1.563	7.500	-	1	1381	16360

*Hot Dipped Galvanized



MALLEABLE IRON/**MECHANICAL GALVANIZED** 90° LIQUIDTIGHT CONNECTORS

FOR LIQUIDTIGHT FLEXIBLE METALLIC CONDUIT

APPLICATION

To secure, ground seal Liquidtight Flexible Metal conduit, to boxes and enclosures

FEATURES

- Tapered threaded male hub NPT
- Compact, slim diameter with small turning radius
- Furnished with an insulated throat with steel locknut and sealing ring
- Liquidtight/Raintight/Oiltight
- Suitable for wet locations
- Long ferrule prevents pullout and tight bend conduit "pop-out"
- UL Listed liquidtight flexible metal conduit fittings are suitable for use in the following Hazardous Locations under NEC 501-4(b), 502-4(a)(2); Class I, Div.2; Class II, Div. 1 and 2; and Class III, Div. 1 and 2 and are suitable for grounding in sizes 3/8" through 1-1/2" under NEC 351-I

STANDARD MATERIALS

Malleable Iron/Steel Ferrule

STANDARD FINISH

Sizes 1/2" - 2" - Mechanical Galvanized
 Sizes 2 1/2" - 4" - Hot Dipped Galvanized



New Product

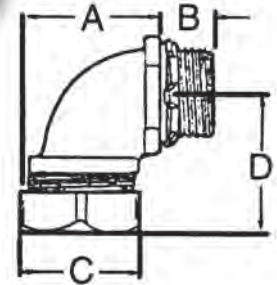

TYPE SLT35TMG

All Furnished with Insulated Throats

CATALOG NUMBER	TRADE SIZE	KO SIZE	I.D.	O.D.	DIM A	DIM B	DIM C	DIM D	UNIT PACK	MASTER PACK	LBS./100 PCS.	UPC #
SLT35TMG	1/2"	1/2"	0.590	0.793	1.43	0.50	1.28	1.37	10	100	31	16405
SLT36TMG	3/4"	3/4"	0.785	1.020	1.62	0.52	1.55	1.50	10	100	46	16410
SLT37TMG	1"	1"	0.980	1.261	1.93	0.65	1.80	1.81	5	50	77	16415
SLT38TMG	1-1/4"	1-1/4"	1.330	1.605	2.37	0.66	2.25	1.94	-	10	98	16420
SLT39TMG	1-1/2"	1-1/2"	1.530	1.844	2.68	0.73	2.44	2.40	-	10	124	16425
SLT40TMG	2"	2"	1.995	2.337	3.18	0.75	2.97	2.64	-	5	179	16430
*SLT65TG	2-1/2"	2-1/2"	2.341	2.797	8.31	1.01	4.01	7.81	-	1	847	16435
*SLT66TG	3"	3"	2.939	3.418	9.80	1.15	4.18	9.15	-	1	1243	16440
*SLT67TG	3-1/2"	3-1/2"	3.406	3.915	11.18	1.18	5.25	11.22	-	1	1914	16445
*SLT68TG	4"	4"	3.882	4.411	12.98	1.25	5.78	12.54	-	1	2399	16450

*Hot Dipped Galvanized



MALLEABLE IRON/**MECHANICAL GALVANIZED** 45° LIQUIDTIGHT CONNECTORS

FOR LIQUIDTIGHT FLEXIBLE METALLIC CONDUIT

APPLICATION

To secure, ground and seal Liquidtight Flexible Metal conduit to boxes and enclosures.

FEATURES

- Tapered threaded male hub NPT
- Compact, slim diameter with small turning radius
- Furnished with an insulated throat with steel locknut and sealing ring
- Liquidtight/Raintight/Oiltight
- Suitable for wet locations
- Long ferrule prevents pullout and tight bend conduit "pop-out"
- UL Listed liquidtight flexible metal conduit fittings are suitable for use in the following Hazardous Locations under NEC 501-4(b), 502-4(a)(2); Class I, Div.2; Class II, Div. 1 and 2; and Class III, Div. 1 and 2 and are suitable for grounding in sizes 3/8" through 1-1/2" under NEC 351-I

STANDARD MATERIALS

Malleable Iron/Steel Ferrule

STANDARD FINISH

Sizes 1/2" - 2" - Mechanical Galvanized
 Sizes 2 1/2" - 4" - Hot Dipped Galvanized



TYPE SLT35-45TMG

All Furnished with Insulated Throats

CATALOG NUMBER	TRADE SIZE	KO SIZE	I.D.	O.D.	DIM A	DIM B	DIM C	DIM D	UNIT PACK	MASTER PACK	LBS./100 PCS.	UPC #
SLT35-45TMG	1/2"	1/2"	0.590	0.793	1.25	0.50	1.28	1.51	10	100	29	16407
SLT36-45TMG	3/4"	3/4"	0.785	1.020	1.28	0.52	1.55	1.54	10	100	42	16412
SLT37-45TMG	1"	1"	0.980	1.261	1.43	0.65	1.80	1.81	5	50	66	16417
SLT38-45TMG	1-1/4"	1-1/4"	1.330	1.605	1.50	0.66	2.25	2.16	-	10	90	16422
SLT39-45TMG	1-1/2"	1-1/2"	1.530	1.844	1.61	0.73	2.44	2.43	-	10	112	16427
SLT40-45TMG	2"	2"	1.995	2.337	1.76	0.75	2.97	2.82	-	5	179	16432
*SLT65-45TG	2-1/2"	2-1/2"	2.341	2.797	2.18	1.01	4.01	4.41	-	1	582	16437
*SLT66-45TG	3"	3"	2.939	3.418	2.50	1.15	4.18	5.50	-	1	869	16442
*SLT67-45TG	3-1/2"	3-1/2"	3.406	3.915	2.61	1.18	5.25	5.93	-	1	1296	16447
*SLT68-45TG	4"	4"	3.882	4.411	2.74	1.25	5.78	8.34	-	1	1539	16452

*Hot Dipped Galvanized



MALLEABLE IRON/**MECHANICAL GALVANIZED** STRAIGHT LIQUIDTIGHT CONNECTORS

WITH COPPER LUGS FOR LIQUIDTIGHT FLEXIBLE METALLIC CONDUIT

APPLICATION

Connects conduit and terminates bonding conductor run externally across liquidtight conduit.

FEATURES

- Tapered threaded male hub NPT
- Compact, slim diameter with small turning radius
- Furnished with Insulated throat, steel locknut, and sealing ring
- Liquidtight/Raintight/Oiltight
- Suitable for grounding & wet locations
- Long ferrule prevents pullout and tight bend conduit 'pop-out'
- UL Listed liquidtight flexible metal conduit fittings are suitable for use in the following Hazardous Locations under NEC 501-4(b), 502-4(a)(2); Class I, Div.2; Class II, Div. 1 and 2; and Class III, Div. 1 and 2 and are suitable for grounding in sizes 3/8" through 1-1/2" under NEC 351-I

STANDARD MATERIALS

Malleable Iron/Steel Ferrule/Copper Grounding Lug

STANDARD FINISH

Sizes 1/2" - 4" - Mechanical Galvanized
 Sizes 5" & 6" - Hot Dipped Galvanized

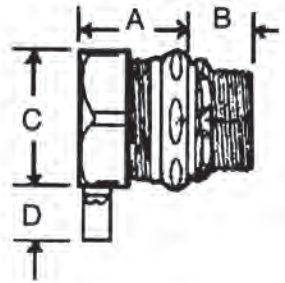

TYPE SLT27CLTMG

All Furnished with Insulated Throats

CATALOG NUMBER	TRADE SIZE	LUG SIZE	I.D.	O.D.	DIM A	DIM B	DIM C	DIM D	UNIT PACK	MASTER PACK	LBS./100 PCS.	UPC #
SLT27CLTMG	1/2"	#4-#14	0.590	0.793	1.25	0.50	1.28	0.75	25	250	20	50503
SLT28CLTMG	3/4"	#4-#14	0.785	1.020	1.28	0.52	1.55	0.75	10	100	31	50506
SLT29CLTMG	1"	#4-#14	0.980	1.261	1.43	0.65	1.80	0.75	5	50	42	50509
SLT30CLTMG	1-1/4"	#4-#14	1.330	1.605	1.50	0.66	2.25	0.75	5	50	57	50512
SLT31CLTMG	1-1/2"	#4-#14	1.530	1.844	1.61	0.73	2.44	0.75	10	50	73	50515
SLT32CLTMG	2"	#4-#14	1.995	2.337	1.76	0.75	2.97	0.75	5	25	101	50518
SLT33CLTMG	2-1/2"	#1/0-#8	2.341	2.797	2.18	1.01	4.01	1.13	1	10	373	50521
SLT34CLTMG	3"	#1/0-#8	2.939	3.418	2.50	1.15	4.18	1.13	1	10	465	50524
SLT60CLTMG	3-1/2"	#3/0-#6	3.406	3.915	2.61	1.18	5.25	1.50	1	10	686	50527
SLT61CLTMG	4"	#3/0-#6	3.882	4.411	2.74	1.25	5.78	1.50	1	5	807	50530
*SLT62CLTG	5"	#6-#250 MCM	391.77	460.78	3.13	1.50	6.06	1.69	-	1	1058	50531
*SLT63CLTG	6"	#6-#250 MCM	484.65	570.18	3.13	1.56	7.50	1.69	-	1	1395	50532

*Hot Dipped Galvanized



MALLEABLE IRON/**MECHANICAL GALVANIZED** 90° LIQUIDTIGHT CONNECTORS

WITH COPPER LUGS FOR LIQUIDTIGHT FLEXIBLE
METALLIC CONDUIT

APPLICATION

Connects conduit and terminates bonding conductor run externally across liquidtight conduit.

FEATURES

- Tapered threaded male hub NPT
- Compact, slim diameter with small turning radius
- Furnished with Insulated throat, steel locknut, and sealing ring
- Liquidtight/Raintight/Oiltight
- Suitable for grounding and wet locations
- Long ferrule prevents pullout and tight bend conduit 'pop-out'
- UL Listed liquidtight flexible metal conduit fittings are suitable for use in the following Hazardous Locations under NEC 501-4(b), 502-4(a)(2); Class I, Div.2; Class II, Div. 1 and 2; and Class III, Div. 1 and 2 and are suitable for grounding in sizes 3/8" through 1-1/2" under NEC 351-I

STANDARD MATERIALS

Malleable Iron/Steel Ferrule/Copper Grounding Lug

STANDARD FINISH

Sizes 1/2" - 2" - Mechanical Galvanized
Sizes 2 1/2" - 4" - Hot Dipped Galvanized



TYPE SLT35CLTMG

All Furnished with Insulated Throats

CATALOG NUMBER	TRADE SIZE	LUG SIZE	I.D.	O.D.	DIM A	DIM B	DIM C	DIM D	DIM E	UNIT PACK	MASTER PACK	LBS. / 100 PCS.	UPC #
SLT35CLTMG	1/2"	#4-#14	0.590	0.793	1.43	0.50	1.28	1.37	0.75	10	100	20	16405
SLT36CLTMG	3/4"	#4-#14	0.785	1.020	1.62	0.52	1.55	1.50	0.75	10	100	31	16410
SLT37CLTMG	1"	#4-#14	0.980	1.261	1.93	0.65	1.80	1.81	0.75	5	50	42	16415
SLT38CLTMG	1-1/4"	#4-#14	1.330	1.605	2.37	0.66	2.25	1.94	0.75	-	10	57	16420
SLT39CLTMG	1-1/2"	#4-#14	1.530	1.844	2.68	0.73	2.44	2.40	0.75	-	10	73	16425
SLT40CLTMG	2"	#4-#14	1.995	2.337	3.18	0.75	2.97	2.64	0.75	-	5	101	16430
*SLT65CLTG	2-1/2"	#1/0-#8	2.341	2.797	8.31	1.01	4.01	7.81	1.13	-	1	373	16435
*SLT66CLTG	3"	#1/0-#8	2.939	3.418	9.80	1.15	4.18	9.15	1.13	-	1	465	16440
*SLT67CLTG	3-1/2"	#3/0-#6	3.406	3.915	11.18	1.18	5.25	11.22	1.50	-	1	686	16445
*SLT68CLTG	4"	#3/0-#6	3.882	4.411	12.93	1.25	5.78	12.54	1.50	-	1	807	16450

*Hot Dipped Galvanized



MALLEABLE IRON/MECHANICAL GALVANIZED 45° LIQUIDTIGHT CONNECTORS

WITH COPPER LUGS FOR LIQUIDTIGHT FLEXIBLE METALLIC CONDUIT

APPLICATION

Connects conduit and terminates bonding conductor run externally across liquidtight conduit.

FEATURES

- Tapered threaded male hub NPT
- Compact, slim diameter with small turning radius
- Furnished with Insulated throat, steel locknut, and sealing ring
- Liquidtight/Raintight/Oiltight
- Suitable for grounding
- Long ferrule prevents pull-out and tight bend conduit "pop-out"
- UL Listed liquidtight flexible metal conduit fittings are suitable for use in the following Hazardous Locations under NEC 501-4(b), 502-4(a)(2); Class I, Div.2; Class II, Div. 1 and 2; and Class III, Div. 1 and 2 and are suitable for grounding in sizes 3/8" through 1-1/2" under NEC 351-I.

STANDARD MATERIALS

Malleable Iron/Steel Ferrule/Copper Grounding Lug

STANDARD FINISH

Sizes 1/2" - 2" - Mechanical Galvanized
 Sizes 2 1/2" - 4" - Hot Dipped Galvanized

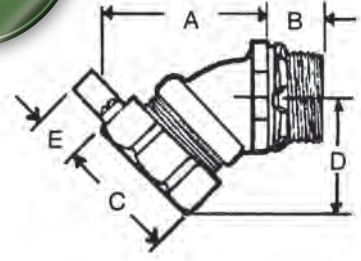

TYPE SLT35-45CLTMG

All Furnished with Insulated Throats

CATALOG NUMBER	TRADE SIZE	LUG SIZE	I.D.	O.D.	DIM A	DIM B	DIM C	DIM D	DIM E	UNIT PACK	MASTER PACK	LBS. / 100 PCS.	UPC #
SLT35-45CLTMG	1/2"	#4-#14	0.590	0.793	1.64	0.50	1.28	1.51	0.75	10	100	20	50569
SLT36-45CLTMG	3/4"	#4-#14	0.785	1.020	1.68	0.52	1.55	1.54	0.75	10	100	31	50572
SLT37-45CLTMG	1"	#4-#14	0.980	1.261	2.16	0.65	1.80	1.81	0.75	5	50	42	50575
SLT38-45CLTMG	1-1/4"	#4-#14	1.330	1.605	2.50	0.66	2.25	2.16	0.75	-	10	57	50578
SLT39-45CLTMG	1-1/2"	#4-#14	1.530	1.844	3.10	0.73	2.44	2.43	0.75	-	10	73	50581
SLT40-45CLTMG	2"	#4-#14	1.995	2.337	3.28	0.75	2.97	2.82	0.75	-	5	101	50584
*SLT65-45CLTG	2-1/2"	#1/0-#8	2.341	2.797	6.67	1.01	4.01	4.41	1.13	-	1	373	50587
*SLT66-45CLTG	3"	#1/0-#8	2.939	3.418	8.01	1.15	4.18	5.50	1.13	-	1	465	50590
*SLT67-45CLTG	3-1/2"	#3/0-#6	3.406	3.915	9.55	1.18	5.25	5.93	1.50	-	1	686	50593
*SLT68-45CLTG	4"	#3/0-#6	3.882	4.411	10.64	1.25	5.78	8.34	1.50	-	1	807	50596

*Hot Dipped Galvanized



ZINC STRAIGHT LIQUIDTIGHT CONNECTORS

FOR LIQUIDTIGHT FLEXIBLE METALLIC CONDUIT

APPLICATION

Terminate and seal liquidtight flexible metal conduit to either oiltight, liquidtight or raintight box or enclosure. Connectors can be used with tapered thread female entry or unthreaded knockout using the provided sealing washer and locknut.

FEATURES

- Furnished with zinc die cast locknut and sealing ring
- Liquidtight/Raintight/Oiltight
- Suitable for grounding (through 1 1/4")
- Suitable for wet locations

STANDARD MATERIALS

Zinc Die Cast



UL LISTED
E198258



TYPE LT27

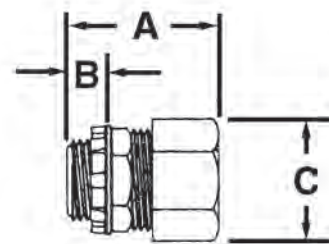

CATALOG NUMBER	TRADE SIZE	DIM A	DIM B	DIM C	UNIT PACK	MASTER PACK	LBS. / 100 PCS.	UPC #
LT47	3/8"	1.440	0.400	1.260	25	250	16	14472
LT27	1/2"	1.500	0.420	1.385	25	250	20	14272
LT28	3/4"	1.600	0.420	1.720	10	100	28	14282
LT29	1"	1.785	0.550	1.900	5	50	44	14292
LT30	1-1/4"	1.900	0.546	2.290	5	50	64	14302
LT31	1-1/2"	2.737	0.520	2.633	-	10	87	14312
LT32	2"	2.080	0.585	3.156	-	5	121	14322
LT33	2-1/2"	3.025	0.775	4.205	-	1	250	14332
LT34	3"	3.530	0.920	4.910	-	1	355	14342
LT60	3-1/2"	3.660	0.920	5.470	-	1	480	14602
LT61	4"	3.875	0.987	5.925	-	1	570	14612

Insulated Throat



TYPE LT27T

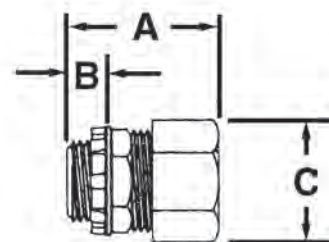

CATALOG NUMBER	TRADE SIZE	DIM A	DIM B	DIM C	UNIT PACK	MASTER PACK	LBS. / 100 PCS.	UPC #
LT47T	3/8"	1.530	0.490	1.260	25	250	16	14478
LT27T	1/2"	1.590	0.510	1.385	25	250	20	14278
LT28T	3/4"	1.690	0.510	1.720	10	100	28	14288
LT29T	1"	1.875	0.530	1.900	5	50	44	14298
LT30T	1-1/4"	1.990	0.636	2.290	5	50	64	14308
LT31T	1-1/2"	2.207	0.610	2.633	-	10	87	14318
LT32T	2"	2.170	0.675	3.156	-	5	121	14328
LT33T	2-1/2"	3.025	0.775	4.205	-	1	250	14338
LT34T	3"	3.530	0.920	4.910	-	1	355	14348
LT60T	3-1/2"	3.660	0.920	5.470	-	1	480	14608
LT61T	4"	3.875	0.987	5.925	-	1	570	14618

ZINC 90° LIQUIDTIGHT CONNECTORS

FOR LIQUIDTIGHT FLEXIBLE METALLIC CONDUIT

APPLICATION

Terminate and seal liquidtight flexible metal conduit, at 90° angle, to either oiltight, liquidtight or raintight box or enclosure.

FEATURES

- Furnished with zinc die cast locknut and sealing ring
- Liquidtight/Raintight/Oiltight
- Suitable for grounding (through 1 1/4")
- Suitable for wet locations

STANDARD MATERIALS

Zinc Die Cast



UL LISTED
E198258



TYPE LT35

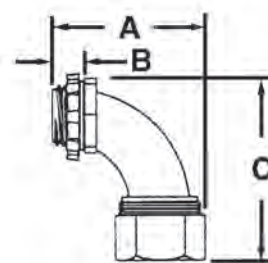

CATALOG NUMBER	TRADE SIZE	DIM A	DIM B	DIM C	UNIT PACK	MASTER PACK	LBS. / 100 PCS.	UPC #
LT25	3/8"	2.062	0.520	2.340	10	100	23	14252
LT35	1/2"	2.220	0.525	2.340	10	100	27	14352
LT36	3/4"	2.550	0.680	3.550	10	100	48	14362
LT37	1"	2.820	0.675	3.785	5	50	76	14372
LT38	1-1/4"	3.362	0.700	3.960	-	10	112	14382
LT39	1-1/2"	3.450	0.700	4.130	-	10	147	14392
LT40	2"	4.036	0.575	4.700	-	5	196	14402
LT65	2-1/2"	5.215	0.770	5.375	-	1	400	14652
LT66	3"	6.100	1.100	6.500	-	1	550	14662
LT67	3-1/2"	6.715	1.100	7.450	-	1	740	14672
LT68	4"	6.780	1.100	8.000	-	1	970	14682

Insulated Throat



TYPE LT35T

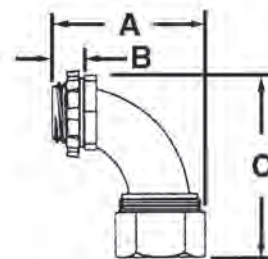

CATALOG NUMBER	TRADE SIZE	DIM A	DIM B	DIM C	UNIT PACK	MASTER PACK	LBS. / 100 PCS.	UPC #
LT25T	3/8"	2.152	0.610	2.340	10	100	23	14258
LT35T	1/2"	2.310	0.615	2.340	10	100	27	14358
LT36T	3/4"	2.640	0.770	3.550	10	100	48	14368
LT37T	1"	2.910	0.765	3.785	5	50	76	14378
LT38T	1-1/4"	3.452	0.790	3.960	-	10	112	14388
LT39T	1-1/2"	3.540	0.790	4.130	-	10	147	14398
LT40T	2"	4.126	0.665	4.700	-	5	196	14408
LT65T	2-1/2"	5.215	0.860	5.375	-	1	400	14658
LT66T	3"	6.100	1.100	6.500	-	1	550	14668
LT67T	3-1/2"	6.715	1.100	7.450	-	1	740	14678
LT68T	4"	6.780	1.100	8.000	-	1	970	14688



AC-MC-FLEX FITTINGS

Big Bite-Saddle Type Connectors with Insulated Throat.....	142	Zinc Straight Cable Connectors.....	149
90° Big Bite-Saddle Type Connectors with Insulated Throat.....	142	Zinc 90° Cable Connectors.....	150
45° Big Bite-Saddle Type Connectors with Insulated Throat.....	143	Zinc Two Screw Take-All Connectors.....	151
Big Bite-Saddle Type Combination Couplings.....	144	Malleable Iron Cable Connectors (Set-Screw, Duplex, 90° Duplex, and 45° Angle).....	152
Cable Chart for Double Bite Connectors.....	145	Zinc Cable and Conduit Connectors (Duplex Single Screw, Duplex Two-Screw, Set-Screw, Two Screw, and Saddle Type).....	154
Quicklock Type Connectors with Insulated Throat.....	146	Combination Couplings.....	156
Malleable Iron Straight Cable Connectors.....	147	Zinc Combination Couplings.....	157
Malleable Iron 90° Cable Connectors.....	148	Cable Chart for Cable Connectors.....	158

BIG BITE-SADDLE TYPE CONNECTORS WITH INSULATED THROAT

FOR ARMORED CABLE, METAL CLAD AND FLEXIBLE METALLIC CONDUIT

APPLICATION

To connect Flex, AC and MC cables to a box or an enclosure.

FEATURES

- One piece tubular construction affording extra strength
- Dual gripping saddle clamps
- Saddle clamp rides up & down on screw for ease of installation
- Robertson Head Screws
- Furnished with Insulated Throat

STANDARD MATERIALS

Tubular Steel/Steel Locknut

STANDARD FINISH

Zinc Plated

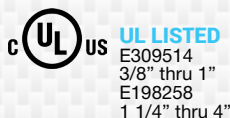

*Please see Cable Chart for Double Bite Connectors on page 145.



TYPE DB50-IC

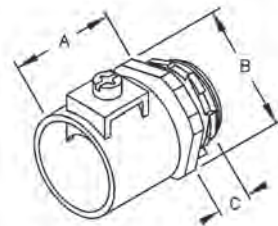

CATALOG NUMBER	TRADE SIZE	CABLE OPENING MAX	CABLE OPENING MIN	KO SIZE	DIM A	DIM B	DIM C	UNIT PACK	MASTER PACK	LBS. / 100 PCS.	UPC #
*DB38-IC	3/8"	0.656	0.437	1/2"	1.188	1.250	0.500	50	500	15	31800
*DB50-IC	1/2"	0.937	0.750	1/2"	1.375	1.250	0.438	25	100	16	31801
*DB75-IC	3/4"	1.125	0.906	3/4"	1.375	1.438	0.438	10	100	17	31802
*DB100-IC	1"	1.468	1.250	1"	1.563	1.813	0.500	5	50	31	31803
DB125-IC	1-1/4"	1.500	1.312	1-1/4"	2.188	2.125	0.625	5	10	53	31804
DB150-IC	1-1/2"	1.750	1.562	1-1/2"	2.438	2.500	0.625	5	10	63	31805
DB200-IC	2"	2.031	1.812	2"	2.563	3.000	0.625	5	10	87	31806
DB250-IC	2-1/2"	3.062	2.812	2-1/2"	2.688	3.625	0.813	1	5	163	31807
DB300-IC	3"	3.562	3.312	3"	2.813	4.250	0.938	1	5	192	31808
DB350-IC	3-1/2"	4.060	3.620	3-1/2"	2.938	4.750	1.000	-	1	225	31809
DB400-IC	4"	4.560	4.120	4"	3.000	5.813	1.031	-	1	263	31810

*Suitable for use on Steel C US or Aluminum Cables.

90° BIG BITE-SADDLE TYPE CONNECTORS WITH INSULATED THROAT

APPLICATION

To connect Flex, AC and MC cables to a box or an enclosure

FEATURES

- Male Hub Threads- NPSM
- One piece malleable construction affording extra strength
- Dual gripping saddle clamps
- Saddle clamp rides up & down on screw for ease of installation
- Robertson Head Screws
- Furnished with Insulated Throat

STANDARD MATERIALS

Malleable Iron/Steel Locknuts/Steel Clamps

STANDARD FINISH

Zinc Plated



*Please see Cable Chart for Double Bite Connectors on page 145.



TYPE DB5090-IC

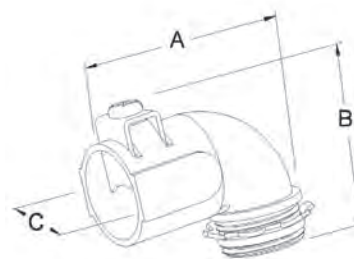

CATALOG NUMBER	TRADE SIZE	CABLE OPENING MAX	CABLE OPENING MIN	KO SIZE	DIM A	DIM B	DIM C	UNIT PACK	MASTER PACK	LBS. / 100 PCS.	UPC #
DB3890-IC	3/8"	0.656	0.437	1/2"	1.750	2.063	1.000	50	500	15	99916
DB5090-IC	1/2"	0.937	0.750	1/2"	2.125	2.250	1.250	25	100	16	99917
DB7590-IC	3/4"	1.125	0.906	3/4"	2.500	2.500	1.375	10	100	17	99918
DB10090-IC	1"	1.468	1.250	1"	2.813	2.875	1.688	5	50	31	99919

45° BIG BITE-SADDLE TYPE CONNECTORS WITH INSULATED THROAT

FOR ARMORED CABLE, METAL CLAD AND FLEXIBLE METALLIC CONDUIT

APPLICATION

To connect Flex, AC and MC cables to a box or an enclosure.

FEATURES

- Male Hub Threads- NPSM
- One piece malleable construction affording extra strength
- Dual gripping saddle clamps
- Saddle clamp rides up & down on screw for ease of installation
- Robertson Head Screws
- Furnished with Insulated Throat

STANDARD MATERIALS

Malleable Iron/Steel Locknuts/Steel Clamps

STANDARD FINISH

Zinc Plated



*Please see Cable Chart for Double Bite Connectors on page 145.

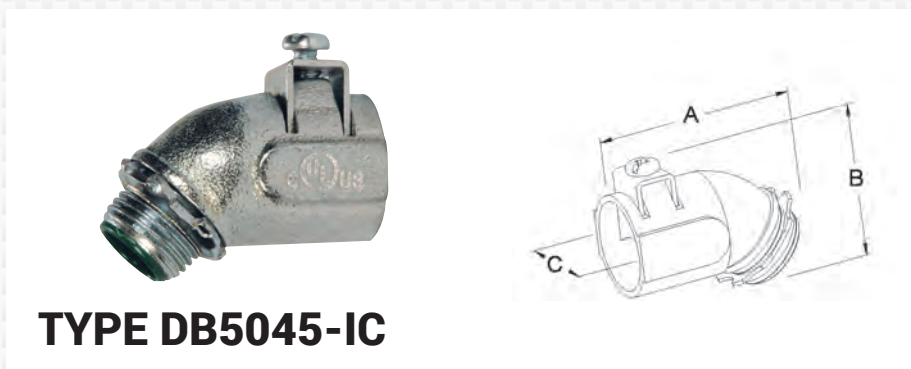

CATALOG NUMBER	TRADE SIZE	CABLE OPENING MAX	CABLE OPENING MIN	KO SIZE	DIM A	DIM B	DIM C	UNIT PACK	MASTER PACK	LBS./100 PCS.	UPC #
DB3845-IC	3/8"	0.656	0.437	1/2"	1.813	1.750	0.938	50	250	16	99913
DB5045-IC	1/2"	0.937	0.750	1/2"	2.125	2.125	1.250	25	100	26	99914
DB7545-IC	3/4"	1.125	0.906	3/4"	2.375	2.313	1.438	10	100	29	99915

BIG BITE-SADDLE TYPE COMBINATION COUPLINGS

FOR ARMORED CABLE, METAL CLAD AND FLEXIBLE METALLIC CONDUIT

APPLICATION

To connect Flex, AC, and MCI cables to EMT Conduit.

FEATURES

- One piece tubular construction affording extra strength
- Dual gripping saddle clamps
- Saddle clamp rides up & down on screw for ease of installation
- Robertson Head Screws

STANDARD MATERIALS

Tubular Steel/ Steel Locknuts/Steel Compression Nut/Steel Gland Ring

STANDARD FINISH

Zinc Plated



UL LISTED
1/2" thru 3/4"
E198258

Compression

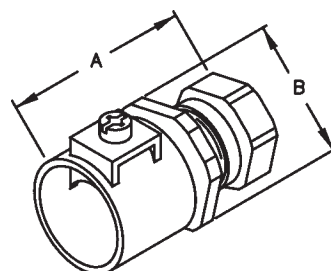

TYPE DBC-50

CATALOG NUMBER	TRADE SIZE	CABLE OPENING MAX	CABLE OPENING MIN	KO SIZE	DIM A	DIM B	UNIT PACK	MASTER PACK	LBS. / 100 PCS.	UPC #
DBC-38	3/8"	0.640	0.280	1/2"	1.375	1.250	50	500	18	99910
DBC-50	1/2"	0.930	0.635	1/2"	1.563	1.250	25	100	19	99911
DBC-75	3/4"	1.125	0.810	3/4"	1.563	1.438	10	100	20	99912

APPLICATION

To connect Flex, AC, and MCI cables to EMT Conduit.

FEATURES

- One piece tubular construction affording extra strength
- Dual gripping saddle clamps
- Saddle clamp rides up & down on screw for ease of installation
- Robertson Head Screws

STANDARD MATERIALS

Tubular Steel

STANDARD FINISH

Zinc Plated



UL LISTED
1/2" thru 3/4"
E198258

Set-Screw

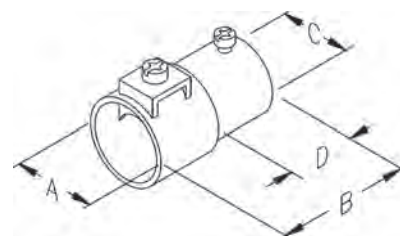

TYPE DBS-50

CATALOG NUMBER	TRADE SIZE	DIM A	DIM B	DIM C	DIM D	UNIT PACK	MASTER PACK	LBS. / 100 PCS.	UPC #
DBS-38	3/8"	0.750	1.563	0.875	0.625	50	500	18	90128
DBS-50	1/2"	1.063	2.000	0.875	0.625	25	100	19	90129
DBS-75	3/4"	1.250	2.125	1.125	0.813	10	100	20	90130

CABLE CHART FOR DOUBLE BITE CONNECTORS

Cable Type

CATALOG NUMBER	AC STEEL	AC STEEL HCF	AC ALUMINUM	AC ALUM HCF	MCI STEEL	MCI ALUM	MCI-A	MCI-A HCF	FLEX CONDUIT
DB38-IC, DB3845-IC, DB3890-IC	14/2, 14/3, 14/4, 12/2, 12/3, 12/4, 10/2 (.450 - .660 Dia)	(.450 - .660 Dia)	14/2, 14/3, 14/4, 12/2, 12/3, 12/4, 10/2 (.450 - .660 Dia)	(.450 - .660 Dia)	14/2, 14/3, 14/4, 12/2, 12/3, 12/4, 10/2 (.450 - .660 Dia)	14/2, 14/3, 14/4, 12/2, 12/3, 12/4, 10/2 (.450 - .660 Dia)	14/2, 14/3, 14/4, 12/2, 12/3, 12/4, 10/2, 10/3 (.400 - .590 Dia)	(.400 - .590 Dia)	3/8"
DB50-IC, DB5045-IC, DB5090-IC	12/4, 10/2, 10/3, 10/4, 8/2, 8/3, 8/4, 6/2, 6/3 (.550 - .920 Dia)	(.550 - .920 Dia)	12/4, 10/2, 10/3, 10/4, 8/2, 8/3, 8/4, 6/2, 6/3 (.550 - .920 Dia)	(.550 - .920 Dia)	10/4, 8/2, 8/3 (.640 - .920 Dia)	10/4, 8/2, 8/3 (.640 - .920 Dia)	12/4, 10/3, 8/4 (.520 - .770 Dia)	(.520 - .770 Dia)	1/2"
DB75-IC, DB7545-IC, DB7590-IC	6/4, 4/2, 4/3 (.930 - 1.075 Dia)	(.930 - 1.075 Dia)	8/3, 6/3, 6/4, 4/3 (.680 - 1.075 Dia)	(.680 - 1.075 Dia)	8/3, 8/4, 6/3, 6/4, 4/3 (.730 - 1.075 Dia)	6/4, 4/3 (.930 - 1.075 Dia)	8/4, 6/4 (.770 - 1.110 Dia)	(.770 - 1.110 Dia)	3/4"
DB100-IC, DB10090-IC	6/4, 4/4, 4/3 3/3, 3/2, 2/4, 2/3, 1/3 (.930 - 1.375 Dia)	(.930 - 1.375 Dia)	6/4, 4/4, 4/3 3/3, 3/2, 2/4, 2/3, 1/3 (.930 - 1.375 Dia)	(.930 - 1.375 Dia)	3/4 (.960 - 1.375 Dia)	6/4, 4/3, 3/4 (.960 - 1.375 Dia)	(.880 - 1.110 Dia)	(.880 - 1.110 Dia)	1"
DB125-IC			(1.150 - 1.335 Dia)			(1.200 - 1.635 Dia)			1 1/4"
DB150-IC						(1.490 - 1.820 Dia)			1 1/2"
DB200-IC						(1.765 - 2.25 Dia)			2"
DB250-IC						(2.270 - 2.950 Dia)			2 1/2"
DB300-IC						(3.160 - 3.480 Dia)			3"
DB350-IC									3 1/2"
DB400-IC									4"

QUICKLOCK TYPE CONNECTORS WITH INSULATED THROAT

FOR ARMORED CABLE, METAL CLAD AND FLEXIBLE METALLIC CONDUIT

APPLICATION

Used to connect MC, AC, and Flex Cable to box or enclosure

FEATURES

- No locknut required
- Single-unit or duplex construction with captive clamp
- Connects 50 MC, AC and Flex RW cable sizes with just three fittings
- Easy to install. Just tilt, insert and snap down
- Single unit construction eliminates loose component parts; integral green plastic insulated throat bushing provides maximum protection for wire installation
- Concrete tight when taped and used with PVC jacketed cord
- Accepts 2 cables of each size listed

STANDARD MATERIALS

Tubular Steel

STANDARD FINISH

Zinc Plated

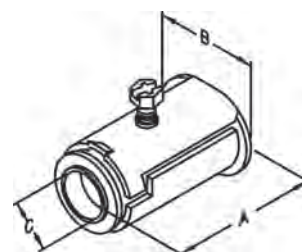

TYPE QL-50

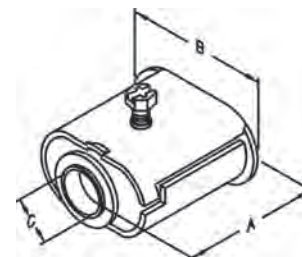

TYPE QL-50D

CATALOG NUMBER	TRADE SIZE	DIM A	DIM B	DIM C	UNIT PACK	MASTER PACK	LBS. / 100 PCS.	UPC #
QL-50	1/2" SINGLE	1.438	0.438	0.438	50	500	8	90001
QL-75	3/4" SINGLE	1.313	0.563	0.563	25	125	14	90002
QL-50D	1/2" DUPLEX	1.688	0.563	0.563	25	125	10	90003

*Please see Cable Chart for Cable Connectors on page 158.

MALLEABLE IRON STRAIGHT CABLE CONNECTORS

FOR ARMORED CABLE AND FLEXIBLE METALLIC CONDUIT

APPLICATION

Used with locknut to terminate steel or aluminum flexible metal conduit to enclosure.

FEATURES

- Male hub threads - NPS
- Provided with steel locknut

STANDARD MATERIALS

Malleable Iron/Steel Locknuts

STANDARD FINISH

Zinc Plated



*Please see Cable Chart for Cable Connectors on page 158.

Squeeze Type

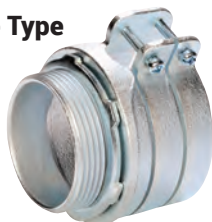

TYPE C34



Sizes 3/8" - 1 1/4" are manufactured as shown above

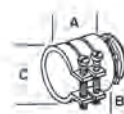

Sizes 1 1/2" - 3" are manufactured as shown above

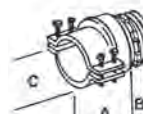

Sizes 3 1/2" - 4" are manufactured as shown above

CATALOG NUMBER	TRADE SIZE	KO SIZE	DIM A	DIM B	DIM C	UNIT PACK	MASTER PACK	LBS. / 100 PCS.	UPC #
C47A	3/8"	1/2"	1.00	0.45	1.60	25	250	6	34708
C27	1/2"	1/2"	1.00	0.45	1.60	25	250	13	32701
C28	3/4"	3/4"	1.10	0.48	1.78	25	250	17	32801
C29	1"	1"	1.10	0.57	2.15	10	100	26	32901
C30	1-1/4"	1-1/4"	1.19	0.57	2.18	10	100	40	33001
C31	1-1/2"	1-1/2"	1.85	0.64	2.25	-	10	63	33101
C32	2"	2"	2.00	0.75	2.70	-	10	107	33201
C33	2-1/2"	2-1/2"	2.05	0.90	3.31	-	10	172	33301
C34	3"	3"	2.15	1.05	3.90	-	5	203	33401
C60	3-1/2"	3-1/2"	3.75	1.31	6.50	-	2	442	36001
C61	4"	4"	4.10	1.50	7.25	-	1	663	36101

Squeeze Type - Insulated Throat



TYPE C34T



Sizes 3/8" - 1 1/4" are manufactured as shown above

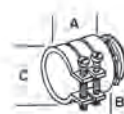

Sizes 1 1/2" - 3" are manufactured as shown above

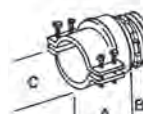

Sizes 3 1/2" - 4" are manufactured as shown above

CATALOG NUMBER	TRADE SIZE	KO SIZE	DIM A	DIM B	DIM C	UNIT PACK	MASTER PACK	LBS. / 100 PCS.	UPC #
C47AT	3/8"	1/2"	1.00	0.45	1.60	25	250	6	34718
C27T	1/2"	1/2"	1.00	0.45	1.60	25	250	13	32703
C28T	3/4"	3/4"	1.10	0.48	1.78	25	250	17	32803
C29T	1"	1"	1.10	0.57	2.15	10	100	26	32903
C30T	1-1/4"	1-1/4"	1.19	0.57	2.18	10	100	40	33003
C31T	1-1/2"	1-1/2"	1.85	0.64	2.25	-	10	64	33103
C32T	2"	2"	2.00	0.75	2.70	-	10	108	33203
C33T	2-1/2"	2-1/2"	2.05	0.90	3.31	-	10	174	33303
C34T	3"	3"	2.15	1.05	3.90	-	5	205	33403
C60T	3-1/2"	3-1/2"	3.75	1.31	6.50	-	2	446	36003
C61T	4"	4"	4.10	1.50	7.25	-	1	670	36103

MALLEABLE IRON 90° CABLE CONNECTORS

FOR ARMORED CABLE AND FLEXIBLE METALLIC CONDUIT

APPLICATION

Used with locknut to terminate steel or aluminum flexible metal conduit to enclosure to form a 90° bend.

FEATURES

- Male hub threads - NPS
- Provided with steel locknut

STANDARD MATERIALS

Malleable Iron/Steel Locknuts

STANDARD FINISH

Zinc Plated



*Please see Cable Chart for Cable Connectors on page 158.

90° Squeeze Type

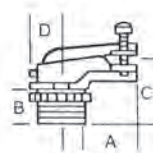

Sizes 3/8" - 1 1/4" are manufactured as shown above

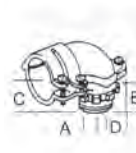

Sizes 1" - 3" are manufactured as shown above

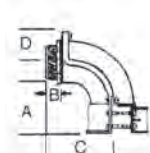

Sizes 3 1/2" - 4" are manufactured as shown above

TYPE C40

CATALOG NUMBER	TRADE SIZE	KO SIZE	DIM A	DIM B	DIM C	DIM D	UNIT PACK	MASTER PACK	LBS. / 100 PCS.	UPC #
C25	3/8"	1/2"	1.63	0.41	0.85	0.51	50	500	9	38025
C35	1/2"	1/2"	1.63	0.41	0.85	0.51	25	250	20	33511
C36	3/4"	3/4"	1.81	0.50	1.10	0.62	10	100	25	33611
C37	1"	1"	2.10	0.50	1.31	0.81	5	50	62	33711
C38	1-1/4"	1-1/4"	2.75	0.65	1.83	1.12	-	10	120	33811
C39	1-1/2"	1-1/2"	3.37	0.65	1.83	1.50	-	10	149	33911
C40	2"	2"	5.00	0.81	2.75	1.70	-	5	309	34011
C65	2-1/2"	2-1/2"	5.50	1.00	4.12	2.00	-	2	352	36511
C66	3"	3"	6.62	1.00	4.50	2.25	-	1	553	36611
C67	3-1/2"	3-1/2"	8.25	1.30	5.56	3.15	-	1	1216	36711
C68	4"	4"	9.30	1.50	7.00	3.45	-	1	1437	36811

90° Squeeze Type - Insulated Throat

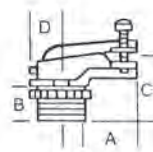

Sizes 3/8" - 1 1/4" are manufactured as shown above

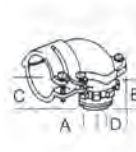

Sizes 1" - 3" are manufactured as shown above

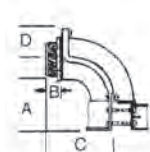

Sizes 3 1/2" - 4" are manufactured as shown above

TYPE C40T

CATALOG NUMBER	TRADE SIZE	KO SIZE	DIM A	DIM B	DIM C	DIM D	UNIT PACK	MASTER PACK	LBS. / 100 PCS.	UPC #
C25T	3/8"	1/2"	1.63	0.41	0.85	0.51	50	500	9	38125
C35T	1/2"	1/2"	1.63	0.41	0.85	0.51	25	250	20	33513
C36T	3/4"	3/4"	1.81	0.50	1.10	0.62	10	100	25	33613
C37T	1"	1"	2.10	0.50	1.31	0.81	5	50	62	33713
C38T	1-1/4"	1-1/4"	2.75	0.65	1.83	1.12	-	10	120	33813
C39T	1-1/2"	1-1/2"	3.37	0.65	1.83	1.50	-	10	149	33913
C40T	2"	2"	5.00	0.81	2.75	1.70	-	5	309	34013
C65T	2-1/2"	2-1/2"	5.50	1.00	4.12	2.00	-	2	352	36513
C66T	3"	3"	6.62	1.00	4.50	2.25	-	1	553	36613
C67T	3-1/2"	3-1/2"	8.25	1.30	5.56	3.15	-	1	1216	36713
C68T	4"	4"	9.30	1.50	7.00	3.45	-	1	1437	36813

ZINC STRAIGHT CABLE CONNECTORS

FOR ARMORED CABLE AND FLEXIBLE METALLIC CONDUIT

APPLICATION

Used with a locknut to terminate steel or aluminum flexible metal conduit and armored cable to enclosure.

FEATURES

→ Assembled with die cast locknut and tri-combo screws

STANDARD MATERIALS

Zinc Die Cast



UL LISTED
E198258
CSA File No. LR57925



*Please see Cable Chart for Cable Connectors on page 158.

Squeeze Type

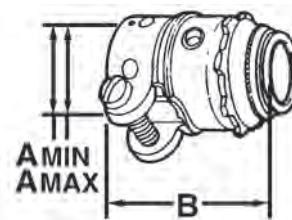
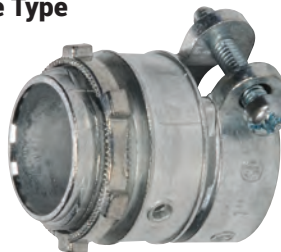

TYPE C27Z

CATALOG NUMBER	TRADE SIZE	DIM. A MIN.	DIM. A MAX	DIM B	UNIT PACK	MASTER PACK	LBS. /100 PCS.	UPC #
C47Z	3/8"	0.530	0.620	0.982	50	500	7	24708
C27Z	1/2"	0.850	0.914	1.470	25	250	10	32708
C28Z	3/4"	1.100	1.135	1.580	25	250	13	32808
C29Z	1"	1.255	1.375	1.750	10	100	20	32908
C30Z	1-1/4"	1.550	1.610	1.910	10	100	29	33008
C31Z	1-1/2"	1.810	1.895	2.090	5	50	39	33108
C32Z	2"	2.260	2.485	2.340	10	40	46	33208

Squeeze Type – Insulated Throat

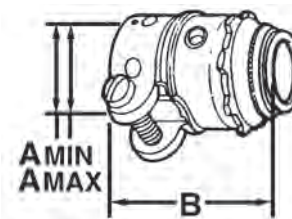

TYPE C27ZT

CATALOG NUMBER	TRADE SIZE	DIM. A MIN.	DIM. A MAX	DIM B	UNIT PACK	MASTER PACK	LBS. /100 PCS.	UPC #
C27ZT	1/2"	0.850	0.914	1.470	25	250	10	32757
C28ZT	3/4"	1.100	1.135	1.580	25	250	13	32867
C29ZT	1"	1.255	1.375	1.750	10	100	20	32967
C30ZT	1-1/4"	1.550	1.610	1.910	10	100	29	33067
C31ZT	1-1/2"	1.810	1.895	2.090	5	50	39	33167
C32ZT	2"	2.260	2.485	2.340	10	40	46	33267

ZINC 90° CABLE CONNECTORS

FOR ARMORED CABLE AND FLEXIBLE METALLIC CONDUIT

APPLICATION

Used with a locknut to terminate steel or aluminum flexible metal conduit and armored cable to enclosure to form a 90° bend

FEATURES

- Assembled with die cast locknut and tri-combo screws

STANDARD MATERIALS

Zinc Die Cast



UL LISTED
E198258
CSA File No. LR57925



*Please see Cable Chart for Cable Connectors on page 158.

Squeeze Type

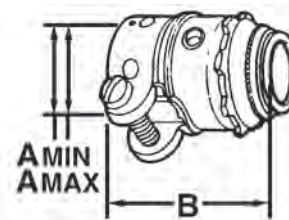

TYPE C40Z

CATALOG NUMBER	TRADE SIZE	DIM. A MIN.	DIM. A MAX	DIM B	UNIT PACK	MASTER PACK	LBS. / 100 PCS.	UPC #
C25Z	3/8"	0.440	0.750	0.180	50	500	7	32252
C35Z	1/2"	0.635	1.085	2.140	25	250	10	33516
C36Z	3/4"	0.830	1.380	2.380	10	100	13	33616
C37Z	1"	1.330	1.570	2.800	5	50	20	33716
C38Z	1-1/4"	1.625	1.940	3.930	10	40	29	33816
C39Z	1-1/2"	1.400	2.400	6.050	-	10	39	33916
C40Z	2"	1.400	2.400	6.050	-	5	46	34016

Squeeze Type – Insulated Throat

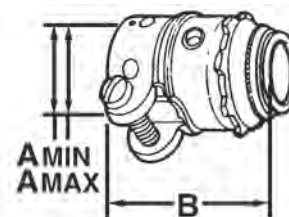

TYPE C40ZT

CATALOG NUMBER	TRADE SIZE	DIM. A MIN.	DIM. A MAX	DIM B	UNIT PACK	MASTER PACK	LBS. / 100 PCS.	UPC #
C25ZT	3/8"	0.440	0.750	0.180	50	500	7	32567
C35ZT	1/2"	0.635	1.085	2.140	25	250	10	33567
C36ZT	3/4"	0.830	1.380	2.380	10	100	13	33667
C37ZT	1"	1.330	1.570	2.800	5	50	20	33767
C38ZT	1-1/4"	1.625	1.940	3.930	10	40	29	33867
C39ZT	1-1/2"	1.400	2.400	6.050	-	10	39	33967
C40ZT	2"	1.400	2.400	6.050	-	5	46	34067

ZINC TWO SCREW TAKE-ALL CONNECTORS

FOR ARMORED CABLE, METAL CLAD, FLEXIBLE METALLIC CONDUIT
AND NON-METAL SHEATHED CABLE

APPLICATION

Used with locknut to terminate service entrance cable to enclosure.

FEATURES

- Take-all Type
- Concrete tight when tapped

STANDARD MATERIALS

Zinc Die Cast



TYPE C50Z

CATALOG NUMBER	TRADE SIZE	DIM. A MIN.	DIM. A MAX	DIM B	UNIT PACK	MASTER PACK	LBS. /100 PCS.	UPC #
C48Z	1/2"	0.40	0.95	1.87	25	250	10	32482
C49Z	3/4"	0.50	1.10	1.84	20	200	12	32492
C50Z	1"	0.62	1.14	2.00	10	100	15	32502
C51Z	1-1/4"	0.50	1.38	2.28	10	100	25	32512
C52Z	1-1/2"	0.75	1.61	2.49	10	100	38	32522
C53Z	2"	0.90	2.04	3.35	5	50	50	32632

*Please see Cable Chart for Cable Connectors on page 158.



TYPE C50ZT

CATALOG NUMBER	TRADE SIZE	DIM. A MIN.	DIM. A MAX	DIM B	UNIT PACK	MASTER PACK	LBS. /100 PCS.	UPC #
C48ZT	1/2"	0.40	0.95	1.87	25	250	10	34867
C49ZT	3/4"	0.50	1.10	1.84	20	200	12	34967
C50ZT	1"	0.62	1.14	2.00	10	100	15	35067
C51ZT	1-1/4"	0.50	1.38	2.28	10	100	25	35167
C52ZT	1-1/2"	0.75	1.61	2.49	10	100	38	35267
C53ZT	2"	0.90	2.04	3.35	5	50	50	35367

MALLEABLE IRON CABLE CONNECTORS

FOR ARMORED CABLE, METAL CLAD AND FLEXIBLE METALLIC CONDUIT

APPLICATION

Used to connect steel armored cable to box or enclosure.

FEATURES

- UL Listed flexible metal conduit fittings are suitable for use in Hazardous Locations under NEC 501-4(b) Class I Div. II, and suitable as a grounding means under NEC 350-5
- Male Hub Threads-NPSM
- Provided with steel locknuts

STANDARD MATERIALS

Malleable Iron / Steel Locknuts

STANDARD FINISH

Zinc Plated



*Please see Cable Chart for Cable Connectors on page 158.

Set-Screw



TYPE C22M

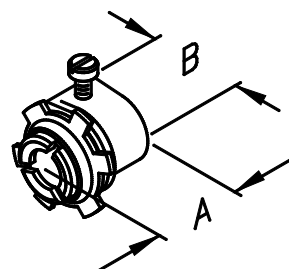

CATALOG NUMBER	TRADE SIZE	KO SIZE	DIM A	DIM B	UNIT PACK	MASTER PACK	LBS. / 100 PCS.	UPC #
C22M	3/8"	1/2"	1.000	0.438	100	1000	7	31240

APPLICATION

Strap type fitting used to connect flexible metal conduit or armored cable to box or enclosure.

FEATURES

- UL Listed flexible metal conduit fittings are suitable for use in Hazardous Locations under NEC 501-4(b) Class I Div. II, and suitable as a grounding means under NEC 350-5
- Male Hub Threads-NPSM
- Provided with steel locknuts
- Stamped Steel Covers

STANDARD MATERIALS

Malleable Iron / Steel Locknuts

STANDARD FINISH

Zinc Plated



Duplex



TYPE C270M

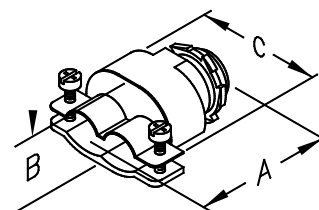

CATALOG NUMBER	TRADE SIZE	KO SIZE	DIM A	DIM B	DIM C	UNIT PACK	MASTER PACK	LBS. / 100 PCS.	UPC #
C270M	3/8"	1/2"	1.688	0.438	1.625	20	200	14	52802

MALLEABLE IRON CABLE CONNECTORS

FOR ARMORED CABLE, METAL CLAD AND FLEXIBLE METALLIC CONDUIT

APPLICATION

To make a 90° termination of flexible metal conduit or cable to a knockout or unthreaded slip hole in a dry location box or enclosure.

FEATURES

- Male Hub Threads - NPSM
- Provided with steel locknuts
- Stamped Steel Covers

STANDARD MATERIALS

Malleable Iron / Steel Locknuts

STANDARD FINISH

Zinc Plated



90° Duplex

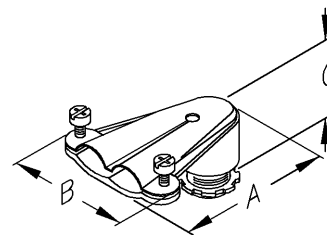

TYPE C271

CATALOG NUMBER	TRADE SIZE	KO SIZE	DIM A	DIM B	DIM C	UNIT PACK	MASTER PACK	LBS. / 100 PCS.	UPC #
C271	3/8"	1/2"	1.188	0.438	0.875	25	250	14	52713

*Please see Cable Chart for Cable Connectors on page 158.

APPLICATION

Connects conduit and terminates bonding conductor.

FEATURES

- Male Hub Threads - NPSM
- Provided with steel locknuts
- Stamped Steel Covers

STANDARD MATERIALS

Malleable Iron / Steel Locknuts

STANDARD FINISH

Zinc Plated



45° Angle

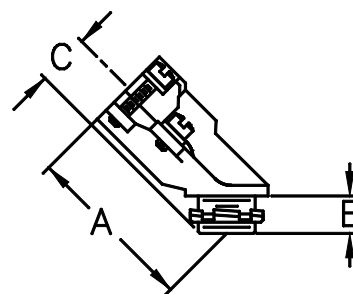

TYPE 315M

CATALOG NUMBER	TRADE SIZE	KO SIZE	DIM A	DIM B	DIM C	UNIT PACK	MASTER PACK	LBS. / 100 PCS.	UPC #
315M	3/8"	1/2"	1.750	0.438	1.125	25	250	10	31502
316M	1/2"	1/2"	1.938	0.438	1.750	25	250	12	70885
317M	3/4"	3/4"	1.938	0.500	2.000	25	250	15	70886

ZINC CABLE AND CONDUIT CONNECTORS

FOR ARMORED CABLE, METAL CLAD AND FLEXIBLE METALLIC CONDUIT

APPLICATION

For use with flexible metal conduit and reduced wall flexible metal conduit, metal clad and armored cable. They are used to connect two, Trade Size 3/8 (12) flexible metal conduits, two armored cable of appropriate size marked, or two metal clad cable of appropriate size marked to an enclosure through a Trade Size 1/2 (16) knockout.

FEATURES

- UL Listed Locknut
- Male hub NPS
- Tri-combo head screws

STANDARD MATERIALS

Zinc Die Cast



UL LISTED
E198258
CSA File No. LR57925



*Please see Cable Chart for Cable Connectors on page 158.

Duplex Single Screw-Clamp Type

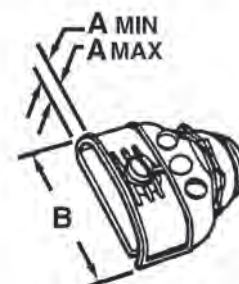

TYPE C270A

CATALOG NUMBER	TRADE SIZE	DIM. A MIN.	DIM. A MAX	DIM B	UNIT PACK	MASTER PACK	LBS. / 100 PCS.	UPC #
C270A	3/8"	0.438	1.688	1.625	25	250	13	52712

APPLICATION

Strap-type fitting used to connect flexible metal conduit or armored cable to box or enclosure.

FEATURES

- UL Listed Locknut
- Male Hub NPS
- Tri-combo head screws

STANDARD MATERIALS

Zinc Die Cast



UL LISTED
E198258
CSA File No. LR57925



Duplex Two-Screw Clamp Type

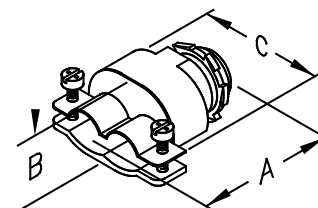

TYPE C270

CATALOG NUMBER	TRADE SIZE	DIM A	DIM B	DIM C	UNIT PACK	MASTER PACK	LBS. / 100 PCS.	UPC #
C270	3/8"	1.688	0.438	1.625	20	200	12	52702

ZINC CABLE AND CONDUIT CONNECTORS

APPLICATION

Used to connect steel armored cable and flexible metallic conduit to a box or enclosure.

FEATURES

- UL Listed Locknut
- End Stopped

STANDARD MATERIALS

Zinc Die Cast



UL LISTED
E198258
CSA File No. LR57925



Set-Screw for Armored Cable and Flexible Metallic Conduit

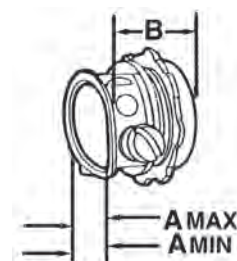

TYPE C22

CATALOG NUMBER	TRADE SIZE	DIM. A MIN.	DIM. A MAX	DIM B	UNIT PACK	MASTER PACK	LBS. /100 PCS.	UPC #
C22	3/8"	0.38	0.63	0.84	100	1000	5	31222

*Please see Cable Chart for Cable Connectors on page 158.

APPLICATION

To terminate regular wall steel or aluminum flexible conduit to a 1/2" knockout in a dry box enclosure.

FEATURES

- UL Listed Locknut
- End Stopped
- Male Hub NPS
- Combination Head Screw

STANDARD MATERIALS

Zinc Die Cast



UL LISTED
E198258
CSA File No. LR57925



Two Screw for Armored Cable, Metal Clad and Flexible Metallic Conduit

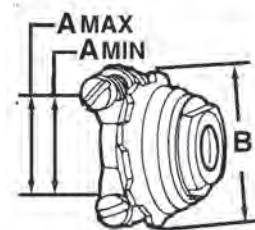

TYPE C23C

CATALOG NUMBER	TRADE SIZE	DIM. A MIN.	DIM. A MAX	DIM B	UNIT PACK	MASTER PACK	LBS. /100 PCS.	UPC #
C23C	3/8"	0.63	0.18	1.20	100	1000	6	32232

ZINC CABLE AND CONDUIT CONNECTORS

FOR ARMORED CABLE, METAL CLAD AND FLEXIBLE METALLIC CONDUIT

APPLICATION

To terminate armored cable in a 1/2" knockout in a dry location box or enclosure.

FEATURES

- Furnished with die cast locknuts
- Tri-combo head screws

STANDARD MATERIALS

Zinc Die Cast



UL LISTED
E309514
CSA File No. LR57925



Saddle Type



TYPE C920

CATALOG NUMBER	TRADE SIZE	DIM. A MIN.	DIM. B MAX	DIM B	UNIT PACK	MASTER PACK	LBS. / 100 PCS.	UPC #
C920	3/8"	0.12	0.63	0.98	50	500	8	13512

*Please see Cable Chart for Cable Connectors on page 158.

COMBINATION COUPLINGS

FOR FLEX METAL CONDUIT TO RIGID OR IMC CONDUIT

APPLICATION

To connect Flexible metal conduit to Rigid or IMC conduit.

FEATURES

- Rigid Conduit to Flex
- Female Hub Threads - NPTt

STANDARD MATERIALS

Malleable Iron

THIRD PARTY CERTIFICATION

STANDARD FINISH:

Zinc Plated



UL LISTED
E198258

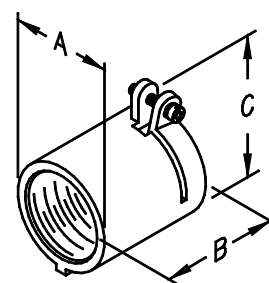

TYPE 22E

CATALOG NUMBER	TRADE SIZE	DIM A	DIM B	DIM C	UNIT PACK	MASTER PACK	LBS. / 100 PCS.	UPC #
22E	1/2"	1.19	1.50	1.69	25	250	14	55221
23E	3/4"	1.38	1.75	1.88	20	200	19	55231
24E	1"	1.63	1.81	2.31	20	100	32	55241
25E	1-1/4"	2.00	2.31	2.62	-	20	36	55251

ZINC COMBINATION COUPLINGS

FOR EMT CONDUIT AND FLEXIBLE METALLIC CONDUIT

APPLICATION

A combination coupling to provide a transition from E.M.T. to flexible metallic conduit.

FEATURES

→ Assembled with tri-combo screws

STANDARD MATERIALS

Zinc Die Cast



UL LISTED
E198258
CSA File No. LR57925



TYPE TYPE 170C

CATALOG NUMBER	TRADE SIZE	DIM A	DIM B	UNIT PACK	MASTER PACK	LBS. /100 PCS.	UPC #
*170C	1/2" EMT - 3/8" Flex	1.280	1.140	50	500	8	51702
171C	1/2" EMT - 1/2" Flex	1.645	1.340	25	250	10	51703
172C	3/4" EMT - 3/4" Flex	1.975	1.535	20	200	15	51704
173C	1" EMT - 1" Flex	2.285	1.700	10	100	26	51705

*Please see Cable Chart for Cable Connectors on page 158.

*EMT TO NM CABLE

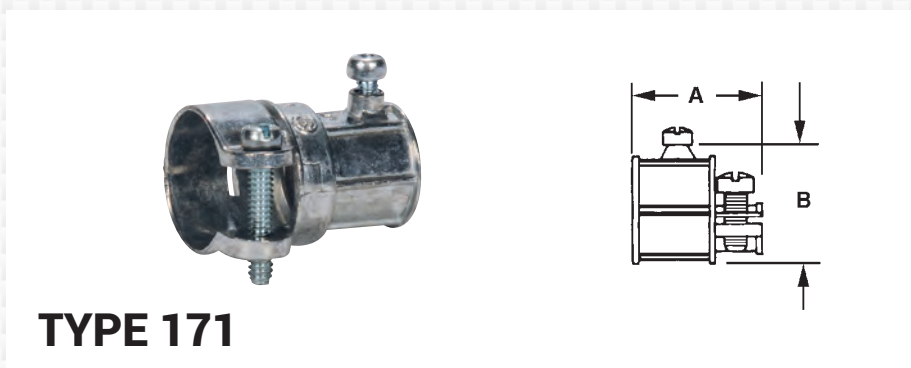

TYPE 171

CATALOG NUMBER	TRADE SIZE	DIM A	DIM B	UNIT PACK	MASTER PACK	LBS. /100 PCS.	UPC #
171	1/2" EMT - 1/2" FMC	1.645	1.340	25	250	10	51712
172	3/4" EMT - 3/4" FMC	1.975	1.535	20	200	15	51722

CABLE CHART FOR CABLE CONNECTORS

SEPCO NUMBERS	K.O. TRADE SIZE	AC CABLE RANGE		MCI CABLE RANGE		MCI-A CABLE RANGE		HCF MCI-A CABLE RANGE	
		STEEL	ALUMINUM	STEEL	ALUMINUM	STEEL	ALUMINUM	STEEL	ALUMINUM
171C	1/2"	8/2 - 6/3 0.630"-0.850"	8/2 - 6/3 0.630"-0.835"	8/3 - 6/2 0.690"-0.850"	8/3 - 6/3 0.690"-0.850"	-	8/3 - 6/3 0.675"-0.785"	-	-
173C	1"	2/4 - 1/0-3 1.151"-1.250"	2/4 - 1/0-3 1.151"-1.250"	1/3 - 1/0-3 1.145"-1.250"	1/3 - 1/0-3 1.145"-1.250"	-	1/3 - 1/0-3 1.145"-1.250"	-	-
315M	1/2"	14/2 - 12/4 0.470"-0.550"	14/2 - 12/4 0.470"-0.550"	14/2 - 8/2 0.470"-0.640"	14/4 - 8/2 0.500"-0.630"	-	14/2 - 8/2 0.400"-0.630"	-	-
316M	1/2"	-	-	-	-	-	-	-	-
317M	3/4"	4/3 0.980"-1.010"	4/3 0.980"-1.010"	6/4 - 4/3 0.950"-1.020"	6/4 - 4/3 0.950"-1.020"	-	6/4 1.050"-1.110"	-	1.050"-1.110"
C22	1/2"	14/2 - 10/2 0.460"-0.598"	-	14/2 - 10/3 0.469"-0.600"	-	-	-	-	-
C22M	1/2"	14/2 - 10/3 0.470"-0.630"	12/2 - 10/3 0.510"-0.625"	12/2 - 10/2 0.490"-0.525"	12/2 - 10/2 0.485"-0.545"	-	14/2 - 10/4 0.400"-0.590"	-	0.400"-0.590"
C23C	1/2"	14/2 - 10/2 0.463"-0.590"	14/2 - 10/2 0.470"-0.552"	14/2 - 10/3 0.460"-0.550"	14/2 - 10/3 0.465"-0.585"	-	12/2 - 10/2 0.435"-0.518"	-	12/2 - 10/2 0.418"-0.495"
C25	3/8"	14/2 - 10/3 0.460"-0.575"	14/2 - 10/3 0.480"-0.600"	14/2 - 10/3 0.469"-0.600"	14/2 - 10/3 0.470"-0.610"	-	-	-	-
C25T	3/8"	14/2 - 10/3 0.460"-0.575"	14/2 - 10/3 0.480"-0.600"	14/2 - 10/3 0.469"-0.600"	14/2 - 10/3 0.470"-0.610"	-	-	-	-
C25Z	1/2"	14/2 - 10/3 0.460"-0.575"	14/2 - 10/3 0.48"-0.60"	14/2 - 10/3 0.469"-0.60"	14/2 - 10/3 0.470"-0.610"	-	10/3 - 10/4 0.495"-0.538"	-	10/2 - 10/4 0.495"-0.584"
C25ZT	1/2"	14/2 - 10/3 0.460"-0.575"	14/2 - 10/3 0.48"-0.60"	14/2 - 10/3 0.469"-0.60"	14/2 - 10/3 0.470"-0.610"	-	10/3 - 10/4 0.495"-0.538"	-	10/2 - 10/4 0.495"-0.584"
C27	1/2"	-	-	-	-	-	-	-	-
C270	1/2"	14/2 - 10/3 0.460"-0.500"	14/2 - 10/3 0.480"-0.580"	14/2 - 10/3 0.470"-0.600"	14/2 - 10/3 0.435"-0.500"	-	-	-	-
C271	1/2"	14/2 - 10/3 0.470"-0.530"	14/2 - 10/3 0.460"-0.625"	14/2 - 10/2 0.485"-0.545"	14/2 - 12/4 0.468"-0.61"	-	14/2 - 8/2 0.400"-0.610"	-	0.400" - 0.610"
C270A	1/2"	14/2 - 10/3 0.460"-0.500"	14/2 - 10/3 0.480"-0.580"	14/2 - 10/3 0.470"-0.600"	14/2 - 10/3 0.468"-0.610"	-	14/2 - 10/3 0.370"-0.495"	-	12/2 - 10/2 0.418"-0.495"
C270M	1/2"	14/2 - 12/4 0.470"-0.560"	14/2 - 12/4 0.470"-0.560"	14/2 - 12/2 0.470"-0.500"	14/2 - 10/3 0.468"-0.610"	-	14/2 - 8/2 0.400"-0.610"	-	0.400"-0.610"
C27T	1/2"	-	-	-	-	-	-	-	-
C27Z	1/2"	6/3 0.885"	6/3 0.880"	6/3 0.860"	6/3 0.865"	-	-	-	-
C27ZT	1/2"	6/3 0.885"	6/3 0.880"	6/3 0.860"	6/3 0.865"	-	-	-	-
C28	3/4"	-	-	-	-	-	-	-	-
C28T	3/4"	-	-	-	-	-	-	-	-
C28Z	3/4"	-	-	-	-	-	-	-	-
C28ZT	3/4"	-	-	-	-	-	-	-	-
C29	1"	-	-	-	-	-	-	-	-
C29T	1"	-	-	-	-	-	-	-	-
C29Z	1"	-	-	-	-	-	-	-	-
C29ZT	1"	-	-	-	-	-	-	-	-
C30	1-1/4"	-	-	-	-	-	-	-	-
C30T	1-1/4"	-	-	-	-	-	-	-	-
C30Z	1-1/4"	-	-	-	-	-	-	-	-
C30ZT	1-1/4"	-	-	-	-	-	-	-	-
C31	1-1/2"	-	-	-	-	-	-	-	-



SEPCO NUMBERS	FMC TRADE SIZE		RWFMC TRADE SIZE		NM CABLE RANGE	FLEX CORD DIA. RANGE	SE OVAL CABLE RANGE	SER ROUND CABLE DIA. RANGE
	STEEL	ALUMINUM	STEEL	ALUMINUM				
171C	1/2"	1/2"	1/2"	1/2"	14/2 - 12/3 0.162" x 0.360" -0.347"	-	-	8/3 0.488"
173C	1"	1"	1"	1"	14/2 - 12/3 0.162" x 0.360" -0.347"	-	-	8/3 - 4/3 0.488" - 0.736"
315M	3/8"	3/8"	3/8"	3/8"	-	-	-	-
316M	1/2"	1/2"	1/2"	1/2"	-	-	-	-
317M	3/4"	3/4"	3/4"	3/4"	-	-	-	-
C22	-	-	-	-	-	-	-	-
C22M	3/8"	3/8"	3/8"	3/8"	-	-	-	-
C23C	3/8"	3/8"	-	-	-	-	-	-
C25	3/8"	3/8"	-	-	-	-	-	-
C25T	3/8"	3/8"	-	-	-	-	-	-
C25Z	3/8"	3/8"	3/8"	3/8"	-	-	-	-
C25ZT	3/8"	3/8"	3/8"	3/8"	-	-	-	-
C27	1/2"	1/2"	1/2"	1/2"	-	-	-	-
C270	3/8"	3/8"	3/8"	3/8"	-	-	-	-
C271	3/8"	3/8"	3/8"	3/8"	-	-	-	-
C270A	3/8"	3/8"	3/8"	3/8"	-	-	-	-
C270M	3/8"	3/8"	3/8"	3/8"	-	-	-	-
C27T	1/2"	1/2"	1/2"	1/2"	-	-	-	-
C27Z	1/2"	1/2"	1/2"	1/2"	-	-	-	-
C27ZT	1/2"	1/2"	1/2"	1/2"	-	-	-	-
C28	3/4"	3/4"	3/4"	3/4"	-	-	-	-
C28T	3/4"	3/4"	3/4"	3/4"	-	-	-	-
C28Z	3/4"	-	3/4"	-	-	-	-	-
C28ZT	3/4"	-	3/4"	-	-	-	-	-
C29	1"	1"	1"	1"	-	-	-	-
C29T	1"	1"	1"	1"	-	-	-	-
C29Z	1"	-	1"	-	-	-	-	-
C29ZT	1"	-	1"	-	-	-	-	-
C30	1-1/4"	1-1/4"	1-1/4"	1-1/4"	-	-	-	-
C30T	1-1/4"	1-1/4"	1-1/4"	1-1/4"	-	-	-	-
C30Z	1-1/4"	1-1/4"	1-1/4"	1-1/4"	-	-	-	-
C30ZT	1-1/4"	1-1/4"	1-1/4"	1-1/4"	-	-	-	-
C31	1-1/2"	1-1/2"	1-1/2"	1-1/2"	-	-	-	-

CABLE CHART FOR CABLE CONNECTORS

SEPCO NUMBERS	K.O. TRADE SIZE	AC CABLE RANGE		MCI CABLE RANGE		MCI-A CABLE RANGE		HCF MCI-A CABLE RANGE	
		STEEL	ALUMINUM	STEEL	ALUMINUM	STEEL	ALUMINUM	STEEL	ALUMINUM
C31T	1-1/2"	-	-	-	-	-	-	-	-
C31Z	1-1/2"	-	-	-	-	-	-	-	-
C31ZT	1-1/2"	-	-	-	-	-	-	-	-
C32	2"	-	-	-	-	-	-	-	-
C32T	2"	-	-	-	-	-	-	-	-
C32Z	2"	-	-	-	-	-	-	-	-
C32ZT	2"	-	-	-	-	-	-	-	-
C33	2-1/2"	-	-	-	-	-	-	-	-
C33T	2-1/2"	-	-	-	-	-	-	-	-
C34	3"	-	-	-	-	-	-	-	-
C34T	3"	-	-	-	-	-	-	-	-
C35	1/2"	8/2 - 8/3	8/2 - 8/3	8/2 - 8/3	8/2 - 8/3	-	-	-	-
C35T	1/2"	8/2 - 8/3	8/2 - 8/3	8/2 - 8/3	8/2 - 8/3	-	-	-	-
C35Z	1/2"	8/2 - 8/3	8/2 - 8/3	8/2 - 8/3	8/2 - 8/3	-	-	-	-
C35ZT	1/2"	8/2 - 8/3	8/2 - 8/3	8/2 - 8/3	8/2 - 8/3	-	-	-	-
C36	3/4"	-	-	-	-	-	-	-	-
C36T	3/4"	-	-	-	-	-	-	-	-
C36Z	3/4"	-	-	-	-	-	-	-	-
C36ZT	3/4"	-	-	-	-	-	-	-	-
C37	1"	-	-	-	-	-	-	-	-
C37T	1"	-	-	-	-	-	-	-	-
C37Z	1"	-	-	-	-	-	-	-	-
C37ZT	1"	-	-	-	-	-	-	-	-
C38	1-1/4"	-	-	-	-	-	-	-	-
C38T	1-1/4"	-	-	-	-	-	-	-	-
C38Z	1-1/4"	-	-	-	-	-	-	-	-
C38ZT	1-1/4"	-	-	-	-	-	-	-	-
C39	1-1/2"	-	-	-	-	-	-	-	-
C39T	1-1/2"	-	-	-	-	-	-	-	-
C39Z	1-1/2"	-	-	-	-	-	-	-	-
C39ZT	1-1/2"	-	-	-	-	-	-	-	-
C40	2"	-	-	-	-	-	-	-	-
C40T	2"	-	-	-	-	-	-	-	-
C40Z	2"	-	-	-	-	-	-	-	-
C40ZT	2"	-	-	-	-	-	-	-	-
C47A	3/8"	12/4 0.520"-0.575"	12/4 0.520"-0.575"	12/3 0.500"-0.539"	14/4 0.494"-0.503"	-	12/4 - 8/2 0.500"-0.590"	-	0.500"-0.610"
C47AT	3/8"	10/3 0.575"	10/3 0.600"	10/3 0.600"	-	-	-	-	-
C47Z	3/8"	12/2 - 10/3 0.525"-0.575"	-	-	-	-	-	-	-
C48Z	1/2"	8/2 - 6/3 0.630"-0.850"	8/2 - 6/3 0.630"-0.835"	8/3 - 6/2 0.690"-0.850"	8/3 - 6/3 0.690"-0.850"	-	8/3 - 6/3 0.675"-0.785"	-	-

SEPCO NUMBERS	FMC TRADE SIZE		RWFMC TRADE SIZE		NM CABLE RANGE	FLEX CORD DIA. RANGE	SE OVAL CABLE RANGE	SER ROUND CABLE DIA. RANGE
	STEEL	ALUMINUM	STEEL	ALUMINUM				
C31T	1-1/2"	1-1/2"	1-1/2"	1-1/2"	-	-	-	-
C31Z	1-1/2"	1-1/2"	1-1/2"	1-1/2"	-	-	-	-
C31ZT	1-1/2"	1-1/2"	1-1/2"	1-1/2"	-	-	-	-
C32	2"	2"	2"	2"	-	-	-	-
C32T	2"	2"	2"	2"	-	-	-	-
C32Z	2"	2"	2"	2"	-	-	-	-
C32ZT	2"	2"	2"	2"	-	-	-	-
C33	2-1/2"	2-1/2"	2-1/2"	2-1/2"	-	-	-	-
C33T	2-1/2"	2-1/2"	2-1/2"	2-1/2"	-	-	-	-
C34	3"	3"	3"	3"	-	-	-	-
C34T	3"	3"	3"	3"	-	-	-	-
C35	1/2"	1/2"	-	-	-	-	-	-
C35T	1/2"	1/2"	-	-	-	-	-	-
C35Z	1/2"	1/2"	1/2"	1/2"	-	-	-	-
C35ZT	1/2"	1/2"	1/2"	1/2"	-	-	-	-
C36	3/4"	3/4"	3/4"	3/4"	-	-	-	-
C36T	3/4"	3/4"	3/4"	3/4"	-	-	-	-
C36Z	3/4"	3/4"	3/4"	3/4"	-	-	-	-
C36ZT	3/4"	3/4"	3/4"	3/4"	-	-	-	-
C37	1"	1"	1"	1"	-	-	-	-
C37T	1"	1"	1"	1"	-	-	-	-
C37Z	1"	1"	1"	1"	-	-	-	-
C37ZT	1"	1"	1"	1"	-	-	-	-
C38	1-1/4"	1-1/4"	1-1/4"	1-1/4"	-	-	-	-
C38T	1-1/4"	1-1/4"	1-1/4"	1-1/4"	-	-	-	-
C38Z	1-1/4"	1-1/4"	1-1/4"	1-1/4"	-	-	-	-
C38ZT	1-1/4"	1-1/4"	1-1/4"	1-1/4"	-	-	-	-
C39	1-1/2"	1-1/2"	1-1/2"	1-1/2"	-	-	-	-
C39T	1-1/2"	1-1/2"	1-1/2"	1-1/2"	-	-	-	-
C39Z	1-1/2"	1-1/2"	1-1/2"	1-1/2"	-	-	-	-
C39ZT	1-1/2"	1-1/2"	1-1/2"	1-1/2"	-	-	-	-
C40	2"	2"	2"	2"	-	-	-	-
C40T	2"	2"	2"	2"	-	-	-	-
C40Z	2"	2"	2"	2"	-	-	-	-
C40ZT	2"	2"	2"	2"	-	-	-	-
C47A	-	-	3/8"	3/8"	-	-	-	-
C47AT	-	-	3/8"	3/8"	-	-	-	-
C47Z	3/8"	3/8"	-	-	-	-	-	-
C48Z	1/2"	1/2"	1/2"	1/2"	14/2 - 12/3	-	-	8/3 0.612"

CABLE CHART FOR CABLE CONNECTORS

SEPCO NUMBERS	K.O. TRADE SIZE	AC CABLE RANGE		MCI CABLE RANGE		MCI-A CABLE RANGE		HCF MCI-A CABLE RANGE	
		STEEL	ALUMINUM	STEEL	ALUMINUM	STEEL	ALUMINUM	STEEL	ALUMINUM
C48ZT	1/2"	8/2 - 6/3 0.630"-0.850"	8/2 - 6/3 0.630"-0.835"	8/3 - 6/2 0.690"-0.850"	8/3 - 6/3 0.690"-0.850"	-	8/3 - 6/3 0.675"-0.785"	-	-
C49Z	3/4"	6/3 - 4/2 0.850"-1.035"	4/3 1.095"	4/3 - 2/3 0.940"-1.080"	4/3 - 2/3 0.940"-1.070"	-	-	-	-
C49ZT	3/4"	6/3 - 4/2 0.850"-1.035"	4/3 1.095"	4/3 - 2/3 0.940"-1.080"	4/3 - 2/3 0.940"-1.070"	-	-	-	-
C50Z	1"	-	-	1/3 - 1/0-3 1.165"-1.220"	1/3 - 1/0-3 1.145"-1.250"	-	-	-	-
C50ZT	1"	-	-	1/3 - 1/0-3 1.165"-1.220"	1/3 - 1/0-3 1.145"-1.250"	-	-	-	-
C51Z	1 1/4"	-	-	1/0-4 - 2/0-4 1.340"-1.450"	-	-	-	-	-
C51ZT	1 1/4"	-	-	1/0-4 - 2/0-4 1.340"-1.450"	-	-	-	-	-
C52Z	1 1/2"	-	-	4/0-4 - 250-4 1.700"-1.845"	-	-	-	-	-
C52ZT	1 1/2"	-	-	4/0-4 - 250-4 1.700"-1.845"	-	-	-	-	-
C53Z	2"	-	-	350-4 - 400-4 2.070"-2.180"	-	-	-	-	-
C53ZT	2"	-	-	350-4 - 400-4 2.070"-2.180"	-	-	-	-	-
C65T	2-1/2"	-	-	-	-	-	-	-	-
C66	3"	-	-	-	-	-	-	-	-
C66T	3"	-	-	-	-	-	-	-	-
C67	3-1/2"	-	-	-	-	-	-	-	-
C67T	3-1/2"	-	-	-	-	-	-	-	-
C68	4"	-	-	-	-	-	-	-	-
C68T	4"	-	-	-	-	-	-	-	-
C920	1/2"	14/2 - 10/3 0.410"-0.610"	14/2 - 10/3 0.410"-0.610"	0.475"-0.600"	0.468"-0.600"	-	0.452"- 0.584"	-	0.452"- 0.584"
QL-50	1/2"	14/2 - 10/3 0.470"-0.630"	14/2 - 10/2 0.480"-0.580"	14/2 - 10/3 0.410"-0.610"	14/2 - 10/3 0.410"-0.610"	-	12/4 - 10/4 0.500"-0.610"	-	0.500"-0.610"
QL-50D**	1/2"	14/2 - 12/4 0.470"-0.575"	14/2 - 10/2 0.480"-0.580"	14/2 - 10/3 0.410"-0.610"	14/2 - 10/3 0.410"-0.610"	-	14/3 - 8/2 0.410"-0.610"	-	0.410"-0.610"
QL-75	3/4"	10/4 - 6/3 0.635"-0.870"	10/4 - 8/4 0.655"-0.810"	10/3 - 8/3 0.562"-0.725"	10/3 - 8/3 0.572"-0.730"	-	8/2 - 8/4 0.610" - 0.760"	-	0.610" - 0.760"

**Accepts 2 cables of each listed size



SEPCO NUMBERS	FMC TRADE SIZE		RWFMC TRADE SIZE		NM CABLE RANGE	FLEX CORD DIA. RANGE	SE OVAL CABLE RANGE	SER ROUND CABLE DIA. RANGE
	STEEL	ALUMINUM	STEEL	ALUMINUM				
C48ZT	1/2"	1/2"	1/2"	1/2"	14/2 - 12/3	-	-	8/3 0.612"
C49Z	3/4"	3/4"	3/4"	3/4"	14/3 - 8/3	-	-	8/3 - 6/3 0.612"-0.717"
C49ZT	3/4"	3/4"	3/4"	3/4"	14/3 - 8/3	-	-	8/3 - 6/3 0.612"-0.717"
C50Z	1" 1.300"-1.380"	1" 1.300"-1.380"	1" 1.300"-1.380"	1" 1.300"-1.380"	10/3 - 6/3 0.360"-0.650	-	4/3 0.499"-0.800"	-
C50ZT	1" 1.300"-1.380"	1" 1.300"-1.380"	1" 1.300"-1.380"	1" 1.300"-1.380"	10/3 - 6/3 0.360"-0.650	-	4/3 0.499"-0.800"	-
C51Z	1 1/4"	1 1/4"	1 1/4"	1 1/4"	8/3 - 2/3	-	-	-
C51ZT	1 1/4"	1 1/4"	1 1/4"	1 1/4"	8/3 - 2/3	-	-	-
C52Z	1 1/2"	1 1/2"	1 1/2"	1 1/2"	2/3	-	-	-
C52ZT	1 1/2"	1 1/2"	1 1/2"	1 1/2"	2/3	-	-	-
C53Z	2"	2"	2"	2"	-	-	-	-
C53ZT	2"	2"	2"	2"	-	-	-	-
C65T	2-1/2"	2-1/2"	2-1/2"	2-1/2"	-	-	-	-
C66	3"	3"	3"	3"	-	-	-	-
C66T	3"	3"	3"	3"	-	-	-	-
C67	3-1/2"	3-1/2"	3-1/2"	3-1/2"	-	-	-	-
C67T	3-1/2"	3-1/2"	3-1/2"	3-1/2"	-	-	-	-
C68	4"	4"	4"	4"	-	-	-	-
C68T	4"	4"	4"	4"	-	-	-	-
C920	3/8"	3/8"	3/8"	3/8"	14/2 - 10/2 0.485"-0.545"	-	-	-
QL-50	3/8"	3/8"	3/8"	3/8"	-	-	-	-
QL-50D**	3/8"	3/8"	3/8"	3/8"	-	-	-	-
QL-75	1/2"	1/2"	1/2"	1/2"	-	-	-	-

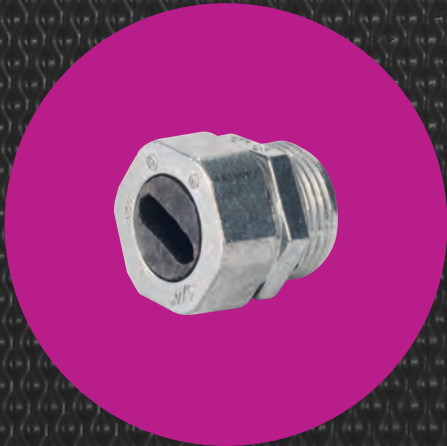

NM CABLE FITTINGS

Zinc Romex Connectors and Service Entrance Connectors.....	166
Zinc Non-Watertight Short Body Connectors.....	167
Zinc Two Screw Take-All Connectors.....	168
Zinc Combination Couplings.....	169
Zinc Underground Feeder Connectors.....	169
Cable Chart for Cable Connectors.....	170

ZINC CABLE AND CONDUIT CONNECTORS

FOR NON-METALLIC SHEATHED CABLE

APPLICATION

Used to connect non-metallic sheath cable and flexible cord from 0.290 to 0.450 in. in diameter to outlet boxes, enclosures, or raceway systems in dry locations.

FEATURES

- Assembled with die cast locknut and tri-combo screws

STANDARD MATERIALS

Zinc Die Cast



Romex Connector



TYPE C23

CATALOG NUMBER	TRADE SIZE	DIM. A MIN.	DIM. A MAX	DIM B	UNIT PACK	MASTER PACK	LBS. / 100 PCS.	UPC #
C23	3/8"	0.64	0.18	1.21	100	1000	5	31232

One or two non-metallic cable 14-2 to 12-2 or 0.29" to 0.45" diameter flexible cord

*Please see Cable Chart for Cable Connectors on page 170.

APPLICATION

Non-watertight. To make a termination of non-metallic sheathed cable and service entrance.

FEATURES

- Assembled with die cast locknut and tri-combo screws

STANDARD MATERIALS

Zinc Die Cast



Service Entrance Connector

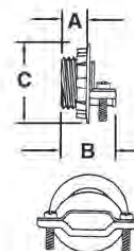
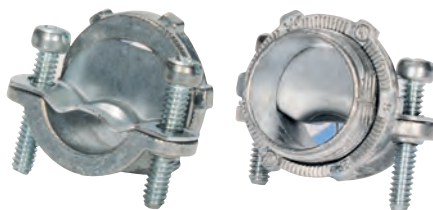

TYPE SC1

CATALOG NUMBER	TRADE SIZE	DIM A	DIM B	DIM C	UNIT PACK	MASTER PACK	LBS. / 100 PCS.	UPC #
SC1	3/4"	0.450	1.031	1.220	25	250	10	32012
SC2	1"	0.645	1.190	1.500	20	200	16	32022
SC3	1-1/4"	0.660	1.330	1.900	10	100	25	32031
SC4	1-1/2"	0.740	1.470	2.115	10	100	36	32042
SC5	2"	0.750	1.620	2.640	5	50	50	32052

CATALOG NUMBER	SE/OVAL DIAMETER IN.	SER/ROUND DIAMETER IN.
SC1	(.52 by .61) and (.51 by .80)	(.57) and (.69)
SC2	(.51 by .80) and (.62 by .975)	(.69) and (.92)
SC3	(1.065 by 0.635) and (1.250 by 0.740)	-
SC4	(1.065 by 0.635) and (1.250 by 0.740)	-
SC5	(1.405 by 0.875) and (1.450 by 0.875)	-

*Please see Cable Chart for Cable Connectors on page 170.

ZINC NON-WATERTIGHT SHORT BODY CONNECTORS

FOR NON-METALLIC SHEATHED CABLE AND SERVICE ENTRANCE CABLE

APPLICATION

Used with locknut to terminate service entrance cable to enclosure.

FEATURES

- Assembled with die cast locknut and tri-combo screws
- For round cable

STANDARD MATERIALS

Zinc Die Cast



*Please see Cable Chart for Cable Connectors on page 170.



CATALOG NUMBER	TRADE SIZE	DIM. A MIN.	DIM. A MAX	DIM B	UNIT PACK	MASTER PACK	LBS. / 100 PCS.	UPC #
C50S	1"	0.620	1.140	1.500	10	100	15	64601
C51S	1-1/4"	0.700	1.380	1.900	10	100	24	64602
C52S	1-1/2"	0.750	1.610	2.115	10	100	34	64603
C53S	2"	0.900	2.040	2.640	5	50	46	64604



CATALOG NUMBER	TRADE SIZE	DIM. A MIN.	DIM. A MAX	DIM B	UNIT PACK	MASTER PACK	LBS. / 100 PCS.	UPC #
C50ST	1"	0.620	1.140	1.500	10	100	15	90138
C51ST	1-1/4"	0.700	1.380	1.900	10	100	24	90139
C52ST	1-1/2"	0.750	1.610	2.115	10	100	34	90140
C53ST	2"	0.900	2.040	2.640	5	50	46	90141

CATALOG NUMBER	SE/OVAL DIAMETER IN.	SER/ROUND DIAMETER IN.
C50S and C50ST Non-Metallic Cable 10-3 through 4-3	(.51 by .80) and (.62 by .975)	(.69) and (.92)
C51S and C51ST Non-Metallic Cable 4-3 through 2-3	(.67 by 1.06) and (.73 by 1.235)	1.19
C52S and C52ST	(1.15 by 0.73) and (1.41 by 0.89)	1.48
C53S and C53ST	(1.405 by 0.875) and (1.450 by 0.875)	-

*Please see Cable Chart for Cable Connectors on page 170.

ZINC TWO SCREW TAKE-ALL CONNECTORS

FOR ARMORED CABLE, METAL CLAD, FLEXIBLE METALLIC CONDUIT AND NON-METAL SHEATHED CABLE

APPLICATION

Used with locknut to terminate service entrance cable to enclosure.

FEATURES

- Take-all Type
- Concrete tight when tapped

STANDARD MATERIALS

Zinc Die Cast



TYPE C50Z

CATALOG NUMBER	TRADE SIZE	DIM. A MIN.	DIM. A MAX	DIM B	UNIT PACK	MASTER PACK	LBS. / 100 PCS.	UPC #
C48Z	1/2"	0.40	0.95	1.87	25	250	10	32482
C49Z	3/4"	0.50	1.10	1.84	20	200	12	32492
C50Z	1"	0.62	1.14	2.00	10	100	15	32502
C51Z	1-1/4"	0.50	1.38	2.28	10	100	25	32512
C52Z	1-1/2"	0.75	1.61	2.49	10	100	38	32522
C53Z	2"	0.90	2.04	3.35	5	50	50	32632

*Please see Cable Chart for Cable Connectors on page 170.



TYPE C50ZT

CATALOG NUMBER	TRADE SIZE	DIM. A MIN.	DIM. A MAX	DIM B	UNIT PACK	MASTER PACK	LBS. / 100 PCS.	UPC #
C48ZT	1/2"	0.40	0.95	1.87	25	250	10	34867
C49ZT	3/4"	0.50	1.10	1.84	20	200	12	34967
C50ZT	1"	0.62	1.14	2.00	10	100	15	35067
C51ZT	1-1/4"	0.50	1.38	2.28	10	100	25	35167
C52ZT	1-1/2"	0.75	1.61	2.49	10	100	38	35267
C53ZT	2"	0.90	2.04	3.35	5	50	50	35367

*Please see Cable Chart for Cable Connectors on page 170.

ZINC CABLE AND CONDUIT FITTINGS

FOR NON-METALLIC SHEATHED CABLE

APPLICATION

Used to join 1/2" steel EMT to 12-2 non-metallic sheath cable.

FEATURES

- Assembled with tri-combo screws

STANDARD MATERIALS

Zinc Die Cast



Combination Couplings

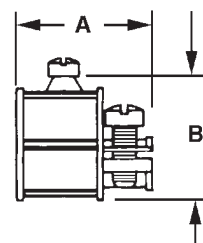

TYPE 170C

CATALOG NUMBER	TRADE SIZE	DIM A	DIM B	UNIT PACK	MASTER PACK	LBS. / 100 PCS.	UPC #
*170C	1/2" E.M.T. - 3/8" Flex	1.28	1.14	50	500	8	51702

* EMT to NM Cable

APPLICATION

Used to connect underground feeder cables to enclosures in wet locations.

FEATURES

- Assembled with a rubber grommet and steel washer

STANDARD MATERIALS

Zinc Die Cast



Underground Feeder Connectors (UF) For Service Entrance Cable and Non-Metallic Sheathed Cable

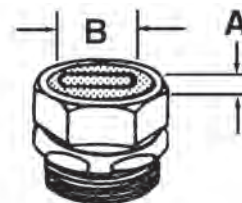

TYPE UF10

CATALOG NUMBER	TRADE SIZE	TYPE	MINIMUM WIRE SIZE		MAX. WIRE SIZE GROM. OPENING		UNIT PACK	MASTER PACK	LBS. / 100 PCS.	UPC #
			A	B	A	B				
UF10	1/2"	12-2	0.100	0.475	0.220	0.440	25	250	17	49899
UF20	3/4"	12-3	0.175	0.800	0.220	0.660	25	250	26	49900

CABLE CHART FOR CABLE CONNECTORS

SEPCO NUMBERS	K.O. TRADE SIZE	AC CABLE RANGE		MCI CABLE RANGE		MCI-A CABLE RANGE		HCF MCI-A CABLE RANGE	
		STEEL	ALUMINUM	STEEL	ALUMINUM	STEEL	ALUMINUM	STEEL	ALUMINUM
C23	3/8"	-	-	-	-	-	-	-	-
C50S	1"	-	-	-	-	-	-	-	-
C50ST	1"	-	-	-	-	-	-	-	-
C51S	1 1/4"	-	-	-	-	-	-	-	-
C51ST	1 1/4"	-	-	-	-	-	-	-	-
C52S	1 1/2"	-	-	-	-	-	-	-	-
C52ST	1 1/2"	-	-	-	-	-	-	-	-
C53S	2"	-	-	-	-	-	-	-	-
C53ST	2"	-	-	-	-	-	-	-	-
C48Z	1/2"	8/2 - 6/3 0.630"-0.850"	8/2 - 6/3 0.630"-0.835"	8/3 - 6/2 0.690"-0.850"	8/3 - 6/3 0.690"-0.850"	-	8/3 - 6/3 0.675"-0.785"	-	-
C48ZT	1/2"	8/2 - 6/3 0.630"-0.850"	8/2 - 6/3 0.630"-0.835"	8/3 - 6/2 0.690"-0.850"	8/3 - 6/3 0.690"-0.850"	-	8/3 - 6/3 0.675"-0.785"	-	-
C49Z	3/4"	6/3 - 4/2 0.850"-1.035"	4/3 1.095"	4/3 - 2/3 0.940"-1.080"	4/3 - 2/3 0.940"-1.070"	-	-	-	-
C49ZT	3/4"	6/3 - 4/2 0.850"-1.035"	4/3 1.095"	4/3 - 2/3 0.940"-1.080"	4/3 - 2/3 0.940"-1.070"	-	-	-	-
C50Z	1"	-	-	1/3 - 1/0-3 1.165"-1.220"	1/3 - 1/0-3 1.145"-1.250"	-	-	-	-
C50ZT	1"	-	-	1/3 - 1/0-3 1.165"-1.220"	1/3 - 1/0-3 1.145"-1.250"	-	-	-	-
C51Z	1 1/4"	-	-	1/0-4 - 2/0-4 1.340"-1.450"	-	-	-	-	-
C51ZT	1 1/4"	-	-	1/0-4 - 2/0-4 1.340"-1.450"	-	-	-	-	-
C52Z	1 1/2"	-	-	4/0-4 - 250-4 1.700"-1.845"	-	-	-	-	-
C52ZT	1 1/2"	-	-	4/0-4 - 250-4 1.700"-1.845"	-	-	-	-	-
C53Z	2"	-	-	350-4 - 400-4 2.070"-2.180"	-	-	-	-	-
C53ZT	2"	-	-	350-4 - 400-4 2.070"-2.180"	-	-	-	-	-
SC1	3/4"	-	-	1/0-4 - 2/0-4 1.340"-1.450"	-	-	-	-	-
SC2	1"	-	-	1/0-4 - 2/0-4 1.340"-1.450"	-	-	-	-	-
SC3	1 1/4"	-	-	1/0-4 - 2/0-4 1.340"-1.450"	-	-	-	-	-
SC4	1 1/2"	-	-	1/0-4 - 2/0-4 1.340"-1.450"	-	-	-	-	-
SC5	2"	-	-	1/0-4 - 2/0-4 1.340"-1.450"	-	-	-	-	-

CABLE CHART FOR CABLE CONNECTORS

SEPCO NUMBERS	FMC TRADE SIZE		RWFMC TRADE SIZE		NM CABLE RANGE	FLEX CORD DIA. RANGE	SE OVAL CABLE RANGE	SER ROUND CABLE DIA. RANGE
	STEEL	ALUMINUM	STEEL	ALUMINUM				
C23	-	-	-	-	(1) 14/2 - 12/2 (2) 14/2	0.209" - 0.450"	-	-
C50S	-	-	-	-	10/3 - 4/3	-	0.510" X 0.800" 0.620" X 0.975"	0.690"-0.920"
C50ST	-	-	-	-	10/3 - 4/3	-	0.510" X 0.800" 0.620" X 0.975"	0.690"-0.920"
C51S	-	-	-	-	4/3 - 2/3	-	0.670" X 0.1.060" 0.730" X 1.235	1.190"
C51ST	-	-	-	-	4/3 - 2/3	-	0.670" X 0.1.060" 0.730" X 1.235	1.190"
C52S	-	-	-	-	-	-	0.730" X 1.150" 0.890" X 1.410"	1.480"
C52ST	-	-	-	-	-	-	0.730" X 1.150" 0.890" X 1.410"	1.480"
C53S	-	-	-	-	-	-	0.875" X 1.405" 0.875" X 1.450"	-
C53ST	-	-	-	-	-	-	0.875" X 1.405" 0.875" X 1.450"	-
C48Z	1/2"	1/2"	1/2"	1/2"	14/2 - 12/3	-	-	8/3 0.612"
C48ZT	1/2"	1/2"	1/2"	1/2"	14/2 - 12/3	-	-	8/3 0.612"
C49Z	3/4"	3/4"	3/4"	3/4"	14/3 - 8/3	-	-	8/3 - 6/3 0.612"-0.717"
C49ZT	3/4"	3/4"	3/4"	3/4"	14/3 - 8/3	-	-	8/3 - 6/3 0.612"-0.717"
C50Z	1" 1.300"-1.380"	1" 1.300"-1.380"	1" 1.300"-1.380"	1" 1.300"-1.380"	10/3 - 6/3 0.360"-0.650	-	4/3 0.499"-0.800"	-
C50ZT	1" 1.300"-1.380"	1" 1.300"-1.380"	1" 1.300"-1.380"	1" 1.300"-1.380"	10/3 - 6/3 0.360"-0.650	-	4/3 0.499"-0.800"	-
C51Z	1 1/4"	1 1/4"	1 1/4"	1 1/4"	8/3 - 2/3	-	-	-
C51ZT	1 1/4"	1 1/4"	1 1/4"	1 1/4"	8/3 - 2/3	-	-	-
C52Z	1 1/2"	1 1/2"	1 1/2"	1 1/2"	2/3	-	-	-
C52ZT	1 1/2"	1 1/2"	1 1/2"	1 1/2"	2/3	-	-	-
C53Z	2"	2"	2"	2"	-	-	-	-
C53ZT	2"	2"	2"	2"	-	-	-	-
SC1	-	-	-	-	10/3 - 8/2	-	0.520" X 0.610" 0.510" X 0.800"	0.57" - 0.69"
SC2	-	-	-	-	10/3 - 4/3	-	0.510" X 0.800" 0.620" X 0.965"	0.69" - 0.92"
SC3	-	-	-	-	-	-	0.635" X 1.065 0.740" X 1.250"	-
SC4	-	-	-	-	-	-	0.635" X 1.065 0.740" X 1.250"	-
SC5	-	-	-	-	-	-	0.875" X 1.405" 0.875" X 1.450"	-



CORD GRIP FITTINGS

Steel Straight Cord Grip Strain Relief Connectors.....	174
Malleable Iron 90° Cord Grip Strain Relief Connectors.....	175
Malleable Iron 45° Cord Grip Strain Relief Connectors.....	176

STEEL STRAIGHT CORD GRIP STRAIN RELIEF CONNECTORS

COLOR CODED - STRAIGHT

APPLICATION

To secure and seal cords or cables entering enclosures or raceways.

FEATURES

- Neoprene Grommet for a moisture proof seal
- Simple installation, cord can be installed without disassembly of the fitting
- Liquidtight/Oiltight/Raintight
- Suitable for NEMA 4 enclosures and other wet locations
- Male tapered thread NPT
- Colored gripper allows for easy identification

STANDARD MATERIALS

Steel Body / Steel Gland Nut Neoprene Grommet

STANDARD FINISH

Zinc Plated



TYPE CG50-250

CATALOG NUMBER	TRADE SIZE	COLOR	CABLE RANGE		UNIT PACK	MASTER PACK	LBS. / 100 PCS.	UPC #
			MIN	MAX				
1/2"								
CG50-250	1/2"	Red	0.15	0.25	25	100	10	85001
CG50-350	1/2"	White	0.25	0.35	25	100	10	85002
CG50-450	1/2"	Blue	0.34	0.45	25	100	10	85003
CG50-560	1/2"	Green	0.45	0.56	25	100	10	85004
CG50-650	1/2"	Brown	0.55	0.65	25	100	10	85005
3/4"								
CG75-250	3/4"	Red	0.15	0.25	10	50	14	85101
CG75-350	3/4"	White	0.25	0.35	10	50	14	85102
CG75-450	3/4"	Blue	0.35	0.45	10	50	14	85103
CG75-560	3/4"	Green	0.45	0.56	10	50	14	85104
CG75-650	3/4"	Brown	0.55	0.65	10	50	14	85105
CG75-750	3/4"	Yellow	0.65	0.75	10	50	14	85106
CG75-850	3/4"	Purple	0.75	0.85	10	50	14	85107
1"								
CG100-560	1"	Green	0.45	0.56	5	25	20	85201
CG100-650	1"	Brown	0.50	0.65	5	25	20	85202
CG100-750	1"	Yellow	0.65	0.75	5	25	20	85203
CG100-850	1"	Purple	0.75	0.85	5	25	20	85204
CG100-950	1"	Grey	0.85	0.95	5	25	20	85205
CG100-1050	1"	Black	0.95	1.05	5	25	20	85206
1-1/4"								
CG125-850	1-1/4"	Purple	0.75	0.85	5	25	40	85301
CG125-950	1-1/4"	Grey	0.85	0.95	5	25	40	85302
CG125-1050	1-1/4"	Black	0.95	1.05	5	25	40	85303
CG125-1150	1-1/4"	Orange	1.05	1.15	5	25	40	85304
CG125-1250	1-1/4"	Red	1.15	1.25	5	25	40	85305
CG125-1375	1-1/4"	White	1.25	1.38	5	25	40	85306
1-1/2"								
CG150-1050	1-1/2"	Black	0.95	1.05	2	10	70	85401
CG150-1150	1-1/2"	Orange	1.05	1.15	2	10	70	85402
CG150-1250	1-1/2"	Red	1.15	1.25	2	10	70	85403
CG150-1375	1-1/2"	White	1.25	1.38	2	10	70	85404

Suitable for use in Hazardous Locations under NEC 501-4(b), 502- 4(a), and 503-3(a). For Class I, Div. 2, Class II, Div. 1, 2, and Class III, Div. 1, 2.



Steel Electric
PRODUCTS

Ph: 718.259.6100 / 800.626.1223 Fax: 718.331.1874

www.sepco-usa.com

MALLEABLE IRON CORD GRIP STRAIN RELIEF CONNECTORS

COLOR CODED - 90°

APPLICATION

To secure and seal cords or cables entering enclosures or raceways.

FEATURES

- Neoprene Grommet for a moisture proof seal
- Simple installation, cord can be installed without disassembly of the fitting
- Liquidtight/Oiltight/Raintight
- Suitable for NEMA 4 enclosures and other wet locations
- Male tapered thread NPT
- Colored gripper allows for easy identification

STANDARD MATERIALS

Malleable Iron Body/Steel Gland Nut/
Neoprene Grommet

STANDARD FINISH

Zinc Plated



CATALOG NUMBER	TRADE SIZE	COLOR	CABLE RANGE		UNIT PACK	MASTER PACK	LBS. / 100 PCS.	UPC #
			MIN	MAX				
1/2"								
CG50-25090	1/2"	Red	0.15	0.25	25	100	10	85501
CG50-35090	1/2"	White	0.25	0.35	25	100	10	85502
CG50-45090	1/2"	Blue	0.34	0.45	25	100	10	85503
CG50-56090	1/2"	Green	0.45	0.56	25	100	10	85504
CG50-65090	1/2"	Brown	0.55	0.65	25	100	10	85505
3/4"								
CG75-25090	3/4"	Red	0.15	0.25	10	50	14	85601
CG75-35090	3/4"	White	0.25	0.35	10	50	14	85602
CG75-45090	3/4"	Blue	0.35	0.45	10	50	14	85603
CG75-56090	3/4"	Green	0.45	0.56	10	50	14	85604
CG75-65090	3/4"	Brown	0.55	0.65	10	50	14	85605
CG75-75090	3/4"	Yellow	0.65	0.75	10	50	14	85606
CG75-85090	3/4"	Purple	0.75	0.85	10	50	14	85607
1"								
CG100-56090	1"	Green	0.45	0.56	5	25	20	85701
CG100-65090	1"	Brown	0.50	0.65	5	25	20	85702
CG100-75090	1"	Yellow	0.65	0.75	5	25	20	85703
CG100-85090	1"	Purple	0.75	0.85	5	25	20	85704
CG100-95090	1"	Grey	0.85	0.95	5	25	20	85705
CG100-105090	1"	Black	0.95	1.05	5	25	20	85706
1-1/4"								
CG125-85090	1-1/4"	Purple	0.75	0.85	5	25	40	85801
CG125-95090	1-1/4"	Grey	0.85	0.95	5	25	40	85802
CG125-105090	1-1/4"	Black	0.95	1.05	5	25	40	85803
CG125-115090	1-1/4"	Orange	1.05	1.15	5	25	40	85804
CG125-125090	1-1/4"	Red	1.15	1.25	5	25	40	85805
CG125-137590	1-1/4"	White	1.25	1.38	5	25	40	85806
1-1/2"								
CG150-105090	1-1/2"	Black	0.95	1.05	2	10	70	85901
CG150-115090	1-1/2"	Orange	1.05	1.15	2	10	70	85902
CG150-125090	1-1/2"	Red	1.15	1.25	2	10	70	85903
CG150-137590	1-1/2"	White	1.25	1.38	2	10	70	85904

Suitable for use in Hazardous Locations under NEC 501-4(b), 502-4(a), and 503-3(a). For Class I, Div. 2, Class II, Div. 1, 2, and Class III, Div. 1, 2.

MALLEABLE IRON CORD GRIP STRAIN RELIEF CONNECTORS

COLOR CODED - 45°

APPLICATION

To secure and seal cords or cables entering enclosures or raceways.

FEATURES

- Neoprene Grommet for a moisture proof seal
- Simple installation, cord can be installed without disassembly of the fitting
- Liquidtight/Oiltight/Raintight
- Suitable for NEMA 4 enclosures and other wet locations
- Male tapered thread NPT
- Colored gripper allows for easy identification

STANDARD MATERIALS

Malleable Iron Body/Steel Gland Nut/
Neoprene Grommet

STANDARD FINISH

Zinc Plated

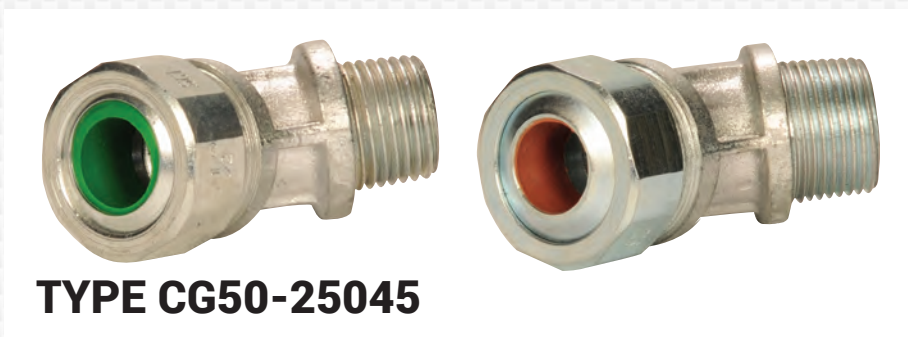

TYPE CG50-25045

CATALOG NUMBER	TRADE SIZE	COLOR	CABLE RANGE		UNIT PACK	MASTER PACK	LBS. / 100 PCS.	UPC #
			MIN	MAX				
1/2"								
CG50-25045	1/2"	Red	0.15	0.25	25	100	10	86001
CG50-35045	1/2"	White	0.25	0.35	25	100	10	86002
CG50-45045	1/2"	Blue	0.34	0.45	25	100	10	86003
CG50-56045	1/2"	Green	0.45	0.56	25	100	10	86004
CG50-65045	1/2"	Brown	0.55	0.65	25	100	10	86005
3/4"								
CG75-25045	3/4"	Red	0.15	0.25	10	50	14	86101
CG75-35045	3/4"	White	0.25	0.35	10	50	14	86102
CG75-45045	3/4"	Blue	0.35	0.45	10	50	14	86103
CG75-56045	3/4"	Green	0.45	0.56	10	50	14	86104
CG75-65045	3/4"	Brown	0.55	0.65	10	50	14	86105
CG75-75045	3/4"	Yellow	0.65	0.75	10	50	14	86106
CG75-85045	3/4"	Purple	0.75	0.85	10	50	14	86107
1"								
CG100-56045	1"	Green	0.45	0.56	5	25	20	86201
CG100-65045	1"	Brown	0.50	0.65	5	25	20	86202
CG100-75045	1"	Yellow	0.65	0.75	5	25	20	86203
CG100-85045	1"	Purple	0.75	0.85	5	25	20	86204
CG100-95045	1"	Grey	0.85	0.95	5	25	20	86205
CG100-105045	1"	Black	0.95	1.05	5	25	20	86206
1-1/4"								
CG125-85045	1-1/4"	Purple	0.75	0.85	5	25	40	86301
CG125-95045	1-1/4"	Grey	0.85	0.95	5	25	40	86302
CG125-105045	1-1/4"	Black	0.95	1.05	5	25	40	86303
CG125-115045	1-1/4"	Orange	1.05	1.15	5	25	40	86304
CG125-125045	1-1/4"	Red	1.15	1.25	5	25	40	86305
CG125-137545	1-1/4"	White	1.25	1.38	5	25	40	86306
1-1/2"								
CG150-105045	1-1/2"	Black	0.95	1.05	2	10	70	86401
CG150-115045	1-1/2"	Orange	1.05	1.15	2	10	70	86402
CG150-125045	1-1/2"	Red	1.15	1.25	2	10	70	86403
CG150-137545	1-1/2"	White	1.25	1.38	2	10	70	86404

Suitable for use in Hazardous Locations under NEC 501-4(b), 502- 4(a), and 503-3(a). For Class I, Div. 2, Class II, Div. 1, 2, and Class III, Div. 1, 2.

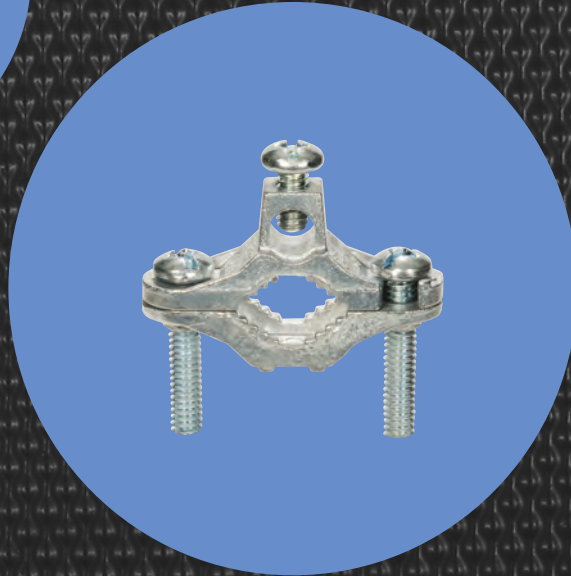
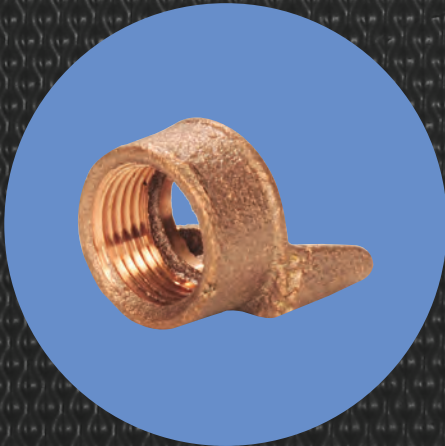
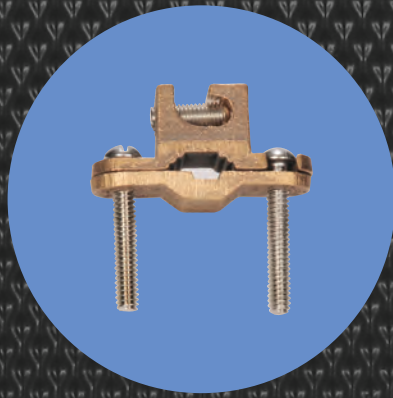

GROUNDING FITTINGS

Ground Clamps.....	178
Ground Clamps, Rod Clamps and Hubs.....	180

GROUND CLAMPS

FOR BARE WIRE

APPLICATION

Used to connect bare copper wire to water pipe, rebar, ground rod or copper water tubing for grounding

STANDARD MATERIALS

Bronze with Steel Screws



UL LISTED
E93683
CSA file No. LR57925



With Steel Screws

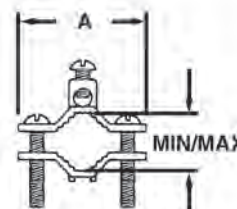

TYPE 34B

CATALOG NUMBER	TRADE SIZE	WIRE SIZE		DIM A	MIN.	MAX.	UNIT PACK	MASTER PACK	LBS. / 100 PCS.	UPC #
		MIN	MAX							
10B	1/2" - 1"	10 SOL.	2 STR.	2.430	0.500	1.380	25	250	19	41054
34B	1-1/4" - 2"	10 SOL.	2 STR.	2.275	0.675	1.850	-	50	40	43414
35A	2-1/2" - 4"	10 SOL.	2 STR.	6.350	2.700	5.900	-	10	135	43514
36A	4" - 6"	10 SOL.	2 STR.	8.000	4.000	7.900	-	5	160	43614

APPLICATION

Used to connect bare copper wire to water pipe, rebar, ground rod or copper water tubing for grounding

STANDARD MATERIALS

Bronze with Bronze Screws



UL LISTED
E93683
CSA file No. LR57925



With Bronze Screws for Direct Burial

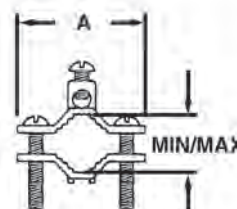

TYPE 10 BR

CATALOG NUMBER	TRADE SIZE	WIRE SIZE		DIM A	MIN.	MAX.	UNIT PACK	MASTER PACK	LBS. / 100 PCS.	UPC #
		MIN	MAX							
10BR	1/2" - 1"	10 SOL.	2 STR.	3.600	1.065	2.680	25	250	21	41084

APPLICATION

Used to connect bare copper wire to water pipe, ground rod or copper water tubing for grounding.

STANDARD MATERIALS

Zinc Die Cast with Steel Screws



UL LISTED
E93683
CSA file No. LR57925



Zinc Die Cast

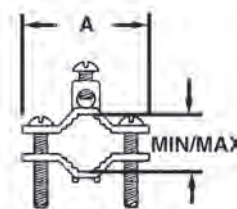

TYPE 10BG

CATALOG NUMBER	TRADE SIZE	WIRE SIZE		DIM A	MIN.	MAX.	UNIT PACK	MASTER PACK	LBS. / 100 PCS.	UPC #
		MIN	MAX							
10BG	1/2" - 1"	8 SOL.	2 STR.	2.220	0.545	1.575	25	250	17	41074
*10BB	1/2" - 1"	8 SOL.	2 STR.	2.400	0.625	2.000	25	250	17	41064

*Brass Colored Zinc Plated

GROUND CLAMPS

FOR ARMORED CABLE

APPLICATION

Used to connect armored cable to water pipe for grounding.

FEATURES

- Special pressure bar grips armored cable insulation to decrease chances of grounding conductor being pulled out

STANDARD MATERIALS

Solid Brass with Steel Screws



UL LISTED
E93683
CSA file No. LR57925



With Steel Screws

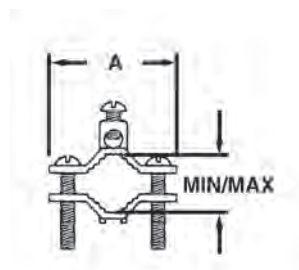
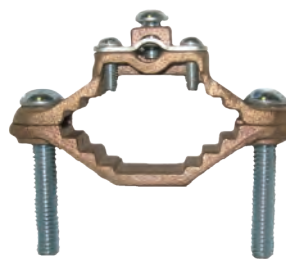

TYPE 35B

CATALOG NUMBER	TRADE SIZE	WIRE SIZE		DIM A	MIN.	MAX.	UNIT PACK	MASTER PACK	LBS. / 100 PCS.	UPC #
		MIN	MAX							
35B	2-1/2" - 4"	8 SOL.	4 STR.	6.350	2.700	5.900	-	10	150	43524

APPLICATION

Integral cast, lay-in lug style direct burial ground clamps are for making connection with #10AWG solid to #2 AWG stranded copper wire to 1/2" to 1" ground water pipe or 3/8" to 1" rebar. Clamps meet both UL and NEC requirements for burial in earth or embedment in concrete. Typical installations include swimming pool and service grounding.

FEATURES

- Combines FOUR clamps into ONE
- It eliminates, rebar clamp, clamp with steel screws, clamp with brass screws, and direct burial clamp
- Configure any job in 1/3 the time by presetting clamps with lay-in feature

STANDARD MATERIALS

Bronze Alloy with Stainless Steel Screws

Patent Pending



UL LISTED
E93683
Listed for Direct Burial
in Earth & Concrete

Patent Pending Direct Burial-Ground Clamp for Rebar



TYPE RBC-50

CATALOG NUMBER	PIPE RANGE	REBAR RANGE	GROUND ROD RANGE	WIRE RANGE	MECHANICAL CONNECTION/ SPLICE	UNIT PACK	MASTER PACK	LBS. / 100 PCS.	UPC #
RBC-50	1/2" - 1"	3/8" - 1"	1/4" - 1"	#10 SOL - #2 STR	TWO #8 SOL	25	250	21	66101

GROUND CLAMPS, ROD CLAMPS AND HUBS

FOR RIGID CONDUIT

APPLICATION

Used to connect grounding conductor in rigid conduit to water pipe for grounding.

STANDARD MATERIALS

Solid Brass with Steel Screws



TYPE 307

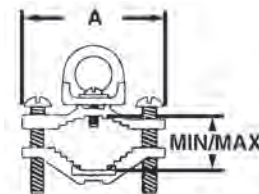
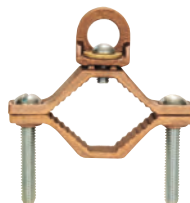

CATALOG NUMBER	TRADE SIZE	HUB SIZE	DIM A	MIN.	MAX.	UNIT PACK	MASTER PACK	LBS. / 100 PCS.	UPC #
301	1/2" - 1"	1/2"	2.250	0.550	1.795	10	100	25	43014
302	1/2" - 1"	3/4"	2.250	0.550	1.795	10	100	30	43024
310	1/2" - 1"	1"	2.250	0.550	1.795	10	50	35	43104
307	1-1/4" - 2"	1/2"	3.600	1.390	3.000	10	50	75	43074
308	1-1/4" - 2"	3/4"	3.600	1.390	3.000	10	50	80	43084
309	1-1/4" - 2"	1"	3.600	1.390	3.600	-	25	85	43094
35C	2-1/2" - 4"	1/2"	2.430	0.500	1.380	-	10	140	43534
36C	4" - 6"	1/2"	8.000	4.000	7.900	-	2	175	43634
35D	2-1/2" - 4"	3/4"	2.430	0.500	1.380	-	10	185	43544
36D	4" - 6"	3/4"	8.000	4.000	7.900	-	2	215	43644
35E	2-1/2" - 4"	1"	2.430	0.500	1.380	-	10	225	43554
36E	4" - 6"	1"	8.000	4.000	7.900	-	2	280	43654

APPLICATION

Used to connect a grounding conductor to a drive.

FEATURES

- Approved for direct burial in ground and concrete
- Assembled with bronze hexagon headed bolt

STANDARD MATERIALS

Copper Alloy with Bronze Bolt

THIRD PARTY CERTIFICATION



Ground Rod Clamps - Listed for Direct Burial

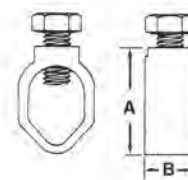

TYPE 201

CATALOG NUMBER	TRADE SIZE	DIM A	DIM B	UNIT PACK	MASTER PACK	LBS. / 100 PCS.	UPC #
200	1/2"	1.250	0.875	-	100	13	52004
201	5/8"	1.275	0.690	-	100	18	52014
202	3/4"	1.445	1.030	-	50	25	52024

APPLICATION

Used with ground pipe clamp to connect rigid conduit to water pipe for grounding.

STANDARD MATERIALS

Copper Alloy

THIRD PARTY CERTIFICATION



Conduit Hubs

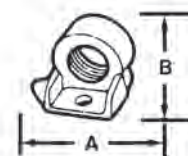

TYPE 311

CATALOG NUMBER	TRADE SIZE	DIM A	DIM B	UNIT PACK	MASTER PACK	LBS. / 100 PCS.	UPC #
311	1/2"	1.000	1.500	25	100	9	43114
312	3/4"	1.250	1.880	25	100	17	43124
313	1"	1.500	2.136	25	100	20	43134

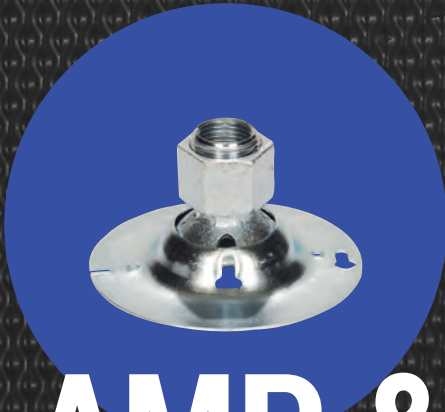

CLAMP & HANGER FITTINGS

Conduit Hangers.....	182
Conduit Clamps.....	183
Conduit Beam Clamps.....	185

CONDUIT HANGERS

FOR THREADED RIGID CONDUIT, IMC, EMT CONDUIT OR PVC CONDUIT

APPLICATION

Secure and suspend rigid conduit, IMC, E.M.T. or PVC conduit overhead supports.

FEATURES

- Supplied with bolts and nuts

STANDARD MATERIALS

Steel

STANDARD FINISH

Zinc Plated



UL LISTED
E198338

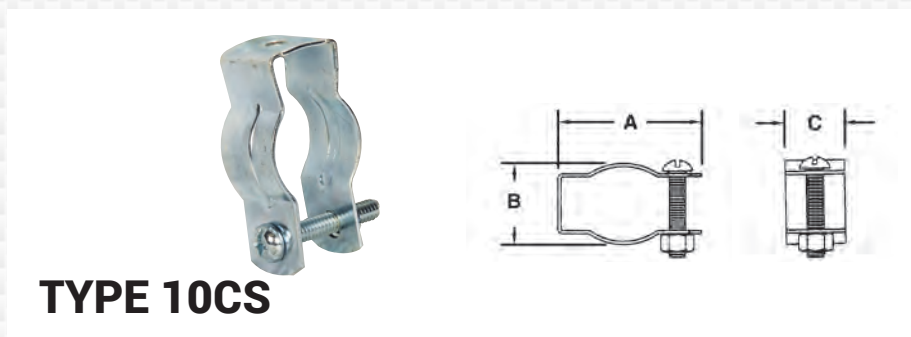

TYPE 10CS

CATALOG NUMBER	TRADE SIZE	DIM A	DIM B	DIM C	UNIT PACK	MASTER PACK	LBS. / 100 PCS.	UPC #
10CS	3/8" - 1/2"	1.875	0.900	0.780	100	500	10	11072
11CS	3/4"	2.175	1.260	0.875	-	100	11	11172
12CS	1"	2.370	1.295	0.875	-	100	12	11272
13CS (Rigid)	1-1/4"	3.255	1.875	0.830	-	100	12	11372
13CSA (E.M.T.)	1-1/4"	3.175	1.965	0.850	-	100	12	11069
14CS	1-1/2"	3.780	2.220	1.065	-	100	21	11472
15CS	2"	4.100	2.450	1.210	-	50	27	11572
16CS	2-1/2"	4.800	3.180	1.240	-	50	30	11672
17CS	3"	5.375	3.750	1.220	-	50	40	11772
18CS	3-1/2"	6.187	4.187	1.270	-	25	42	11872
19CS	4"	6.240	4.430	1.250	-	25	42	11972

APPLICATION

Ball type swivel fixture covers for mounting pendant or fluorescent lighting fixtures to box. Furnished with 3/4" x 1/2" steel reducing bushing.

FEATURES

- For use with 1/2" x 3/4" fixture conduit stems
- Available for use with octagonal or square boxes
- Easily attached by 2 screws
- Suitable for damp locations
- Vertical max slope angles 25°

STANDARD MATERIALS

Steel/Malleable Iron

STANDARD FINISH

Zinc Plated



UL LISTED
E198259

Swivel Fixture Hangers

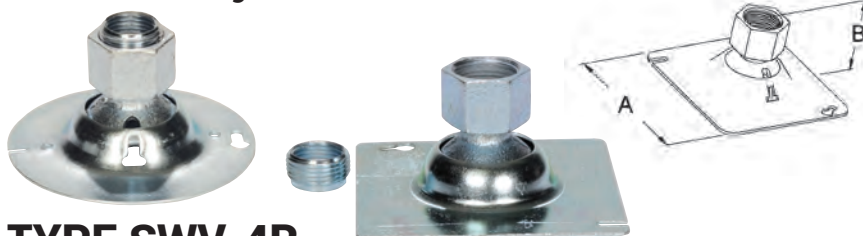

TYPE SWV-4R

CATALOG NUMBER	TRADE SIZE	DIAMETER	DIM A	DIM B	UNIT PACK	MASTER PACK	LBS. / 100 PCS.	UPC #
SWV-4R	3/4"	4.125	X	2.813	-	25	78	95001
SWV-4S	3/4"	X	4.125	2.813	-	25	78	95002

Loading Capacity 50 pounds

CONDUIT CLAMPS

FOR THREADED RIGID CONDUIT, IMC AND EMT CONDUIT

APPLICATION

Used to secure conduit or E.M.T. across, parallel, or perpendicular to beam, channel and angle supports.

FEATURES

- Easily Installed
- Capable of withstanding heavy loads
- A Mechanically Galvanized finish provides a plating thickness equivalent to Hot-Dip process meeting ASTM A-153 performance criteria

STANDARD MATERIALS

Malleable Iron with Steel U-Bolts and Nuts

STANDARD FINISH

Hot-Dip Galvanized



Right Angle Type Conduit Clamps

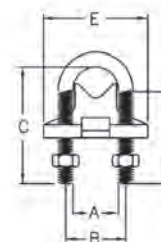

TYPE RA75

CATALOG NUMBER	TRADE SIZE	DIM A	DIM B	DIM C	DIM D	DIM E	UNIT PACK	MASTER PACK	LBS. / 100 PCS.	UPC #
RA50	1/2"	1.000	1.250	2.500	1.813	2.063	-	50	34	74050
RA75	3/4"	1.125	1.375	2.813	1.813	2.250	-	50	38	74075
RA100	1"	1.375	1.625	3.063	1.813	2.563	-	50	45	74100
RA125	1-1/4"	1.750	2.000	3.188	1.813	2.875	-	25	49	74125
RA150	1-1/2"	2.000	2.375	3.500	1.813	3.250	-	25	54	74150
RA200	2"	2.500	2.500	4.500	2.625	4.063	-	25	71	74200
RA250	2-1/2"	3.000	3.250	4.875	2.625	4.500	-	10	90	74250
RA300	3"	3.625	3.875	5.375	2.625	5.125	-	10	101	74300
RA350	3-1/2"	4.063	4.563	5.875	2.625	5.625	-	10	110	74350
RA400	4"	4.688	5.063	6.688	2.625	6.125	-	10	128	74400

Parallel Type Conduit Clamps

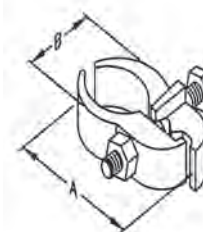

TYPE PAR50

CATALOG NUMBER	TRADE SIZE	DIM A	DIM B	UNIT PACK	MASTER PACK	LBS. / 100 PCS.	UPC #
PAR50	1/2"	2.875	1.438	-	50	54	75550
PAR75	3/4"	3.063	1.688	-	50	61	75551
PAR100	1"	3.250	2.000	-	50	62	75552
PAR125	1-1/4"	3.625	2.125	-	50	82	75553
PAR150	1-1/2"	3.875	2.188	-	50	85	75554
PAR200	2"	4.625	2.875	-	50	103	75556
PAR250	2-1/2"	5.250	3.250	-	50	127	75557
PAR300	3"	5.875	3.875	-	50	154	75558
PAR350	3-1/2"	6.313	4.313	-	50	163	75559
PAR400	4"	6.813	4.813	-	50	180	75560

CONDUIT CLAMPS

FOR THREADED RIGID CONDUIT, IMC AND EMT CONDUIT

APPLICATION

Used to secure conduit or E.M.T. across, parallel, or perpendicular to beam, channel and angle supports.

FEATURES

- Easily Installed
- Capable of withstanding heavy loads
- A Mechanically Galvanized finish provides a plating thickness equivalent to Hot-Dip process meeting ASTM A-153 performance criteria

STANDARD MATERIALS

Malleable Iron/Steel U-Bolts and Nuts

STANDARD FINISH

Hot-Dip Galvanized



Edge Type Conduit Clamps

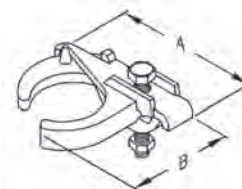

TYPE EDG75

CATALOG NUMBER	TRADE SIZE	DIM A	DIM B	UNIT PACK	MASTER PACK	LBS. / 100 PCS.	UPC #
EDG50	1/2"	2.813	2.125	-	50	10	30750
EDG75	3/4"	2.938	2.375	-	50	11	37075
EDG100	1"	3.063	2.625	-	50	12	37100
EDG125	1-1/4"	3.063	3.063	-	25	12	37125
EDG150	1-1/2"	3.938	3.250	-	25	12	37150
EDG200	2"	4.500	4.063	-	25	21	37200
EDG250	2-1/2"	5.125	4.625	-	10	27	37250
EDG300	3"	5.750	5.250	-	10	30	37300

APPLICATION

For use with all types metallic and flex conduit. Design of clamp style can be used for application where conduit is clamped directly to beam. Can be used for parallel to beam and 90° conduit runs.

STANDARD MATERIALS

Malleable Iron/Steel Bolt-Case Hardened

STANDARD FINISH

Zinc Plated



J-Clamp

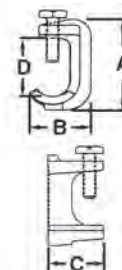

TYPE JC50

CATALOG NUMBER	TRADE SIZE	TAP SIZE	DIM A	DIM B	DIM C	DIM D	UNIT PACK	MASTER PACK	LBS. / 100 PCS.	UPC #
JC50	1/2"	5/16"	2.500	1.563	1.375	1.625	25	100	10	72050
JC75	3/4"	5/16"	2.875	1.875	1.375	2.000	25	100	11	72075
JC100	1"	5/16"	3.500	2.188	1.750	2.188	10	100	12	72100
JC125	1-1/4"	3/8"	3.750	2.500	1.750	2.188	-	25	12	72125
JC150	1-1/2"	3/8"	4.063	2.875	2.000	2.750	-	25	12	72150
JC200	2"	1/2"	4.938	3.250	2.188	3.438	-	25	21	72200



Steel Electric
PRODUCTS

Ph: 718.259.6100 / 800.626.1223 Fax: 718.331.1874

www.sepco-usa.com

CONDUIT BEAM CLAMPS

FOR THREADED RIGID CONDUIT

APPLICATION

Provides support for conduit hanging systems.

FEATURES

- Steel bolt - case hardened
- Standard Sizes 1"-2 1/2"
Jaw Opening 3/4"-1 1/4"

STANDARD MATERIALS

Malleable Iron/Steel Bolt-Case Hardened

STANDARD FINISH

Zinc Plated

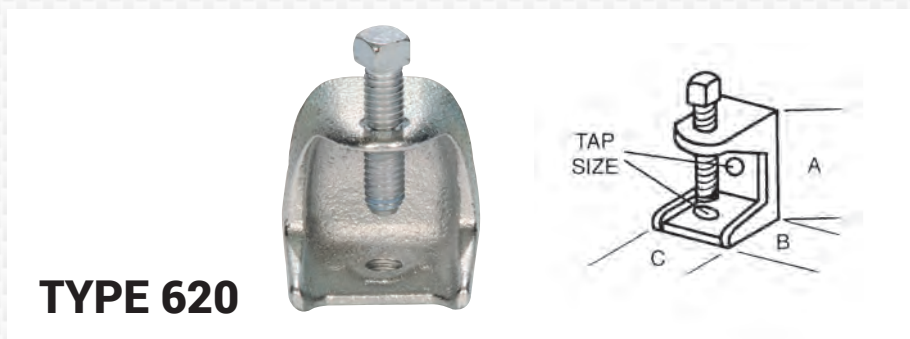

TYPE 620

CATALOG NUMBER	TRADE SIZE	TAP SIZE	JAW OPENING	DIM A	DIM B	DIM C	UNIT PACK	MASTER PACK	LBS. / 100 PCS.	UPC #
620	1"	1/4" - 20"	0.750	1.125	1.400	1.385	25	250	22	16201
621	1"	3/8" - 16"	0.750	1.125	1.400	1.385	25	250	22	16211
625	2"	3/8" - 16"	0.875	1.990	1.755	1.885	-	50	90	16251
626	2"	1/2" - 13"	0.875	1.990	1.755	1.885	-	25	90	16261
627	2-1/2"	1/2" - 13"	1.250	2.530	2.140	2.500	-	25	160	16271

Loading Capacity

CATALOG NUMBER	TRADE SIZE	WORKING LOAD	TEST LOAD FOR 5 MIN.
620	1"	250 LBS	750 LBS
621	1"	250 LBS	750 LBS
625	2"	500 LBS	1500 LBS
626	2"	500 LBS	1500 LBS
627	2-1/2"	500 LBS	1500 LBS

APPLICATION

Clamp on to structure member to provide mounting means for the attachment of conduit hangers either directly or by means of threaded rod.

STANDARD MATERIALS

- Steel

STANDARD FINISH

Zinc Plated



Insulator Supports

TYPE S620

CATALOG NUMBER	TRADE SIZE	DIM A	DIM B	DIM C	UNIT PACK	MASTER PACK	LBS. / 100 PCS.	UPC #
S620	1/4" - 20"	0.920	1.400	1.625	25	250	15	16207



SERVICE ENTRANCE FITTINGS

Zinc Watertight Connectors.....	188	Zinc Cable and Conduit Connectors.....	193
Aluminum Service Entrance Heads.....	189	Zinc Non-Watertight Short Body Connectors.....	194
Aluminum Service Entrance Ells with Cover and Gasket.....	191	Zinc Two Screw Take-All Connectors.....	195
Entrance Heads.....	192	Service Entrance Straps and Sill Plates.....	196
		Cable Chart for Cable Connectors.....	197

ZINC WATERTIGHT CONNECTORS

FOR SERVICE ENTRANCE CABLE

APPLICATION

Used to connect service entrance cable to a service enclosure in wet locations.

FEATURES

- 2 Insulating Connectors, 1 Bare
- U-Flat Style
- Assembled with rubber grommet and steel washer

STANDARD MATERIALS

Zinc Die Cast

STANDARD FINISH

Zinc Die Cast



UL LISTED
E198257



TYPE 1069C

CATALOG NUMBER	TRADE SIZE	WIRE SIZE	MINIMUM WIRE SIZE		MAX. WIRE SIZE GROM OPENING		UNIT PACK	MASTER PACK	LBS./100 PCS.	UPC #
			A	B	A	B				
1060	1"	3 #6	0.310	0.585	0.460	0.715	10	100	34	13642
1060A	1"	3 #4	0.355	0.680	0.530	0.850	10	100	34	13652
1064	1-1/4"	3 #3	0.455	0.815	0.550	0.910	10	100	52	13662
1066	1-1/4"	3 #2	0.480	0.845	0.580	0.960	10	100	52	13672
1066A	1-1/4"	3 #1	0.525	0.955	0.660	1.120	10	100	52	10660
1068	1-1/2"	3 #1/0	0.555	1.095	0.705	1.195	5	50	65	13682
1068A	1-1/2"	3 #2/0	0.595	1.125	0.740	1.235	5	50	65	13683
1069	2"	3 #1/0	0.585	1.085	0.750	1.195	5	50	87	13692
1069A	2"	3 #2/0	0.635	1.165	0.740	1.235	5	50	87	13693
1069B	2"	3 #3/0	0.685	1.285	0.830	1.415	5	50	87	1369420
1069C	2"	3 #4/0	0.655	1.275	0.890	1.540	5	50	87	13695
1069D	2"	3 #4/0	0.705	1.385	0.995	1.580	5	50	87	13696

ALUMINUM SERVICE ENTRANCE HEADS

FOR THREADED RIGID CONDUIT

APPLICATION

Threaded type head used with threaded rigid conduit and IMC for pulling service drop conductors

FEATURES

- Weather resistant
- Assembled with electrical grade phenolic insulator with multiple hole

STANDARD MATERIALS

Aluminum
Phenolic Insulator



UL LISTED
E198257



Threaded

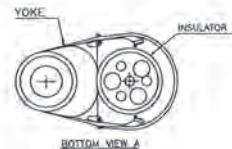
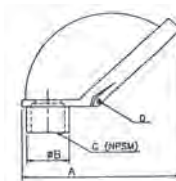

TYPE 400

CATALOG NUMBER	TRADE SIZE	DIM A	DIM B	NPSM THREAD 'C' SIZE	HOOD + YOKE SCREW 'D' (2NOS.)	INSULATOR 'E' CAP SIZE	UNIT PACK	MASTER PACK	LBS. / 100 PCS.	UPC #
400	1/2"	2.7462	1.3435	1/2 - 14	10-24 x 1/2	ECI-050	10	50	25	40050
401	3/4"	3.1244	1.4342	3/4 - 14	10-24 x 1/2	ECI-075	10	50	32	40150
402	1"	3.4475	1.7139	1 - 11.5	10-24 x 1/2	ECI-100	10	50	48	40250
403	1-1/4"	4.1567	1.8835	1-1/4 - 11.5	10-24 x 1/2	ECI-125	-	25	53	40350
404	1-1/2"	5.2087	2.1670	1-1/2 - 11.5	10-24 x 1/2	ECI-150	-	10	112	40450
405	2"	6.6744	2.6950	2 - 11.5	10-24 x 1/2	ECI-200	-	5	130	40550
406	2-1/2"	9.3142	3.3057	2-1/2 - 8	5/16 - 18 x 25/32	ECI-250	-	2	416	40650
407	3"	12.2731	4.1252	3 - 8	5/16 - 18 x 25/32	ECI-250	-	1	418	40750
408	3-1/2"	12.7656	4.5940	3-1/2 - 8	5/16 - 18 x 25/32	ECI-300-7	-	1	810	40850
409	4"	12.7656	5.0787	4 - 8	5/16 - 18 x 25/32	ECI-300-6	-	1	835	40950

ALUMINUM SERVICE ENTRANCE HEADS

FOR THREADED RIGID CONDUIT, IMC AND EMT CONDUIT

APPLICATION

Clamp-on type head used with rigid conduit, IMC or E.M.T. for pulling service drop conductors

FEATURES

- Bar type Clamp
- Heavy pressure clamp in body
- Screw does not bear directly on conduit
- Weather resistant
- Assembled with electrical grade phenolic insulator with multiple holes

STANDARD MATERIALS

Aluminum
Phenolic Insulator



Clamp-On Type

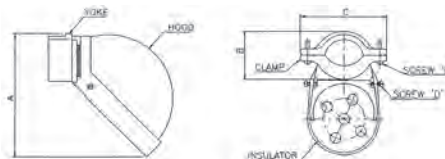

TYPE 425

CATALOG NUMBER	TRADE SIZE	DIM A	DIM B	DIM C	HOOD + YOKE SCREW 'D' (2NOS.)	CLAMP + YOKE SCREW 'E' (2NOS.)	INSULATOR 'F' CAP SIZE	UNIT PACK	MASTER PACK	LBS. / 100 PCS.	UPC #
425	1/2"	2.7462	1.1584	2.2694	10-24 x 1/2	10-24 x 1	ECI-050	10	50	30	42250
426	3/4"	3.1244	1.3711	2.4743	10-24 x 1/2	10-24 x 1	ECI-075	5	25	39	42650
427	1"	3.4475	1.6233	2.7580	10-24 x 1/2	10-24 x 1	ECI-100	5	25	54	42750
428	1-1/4"	4.1567	2.0015	3.1205	10-24 x 1/2	10-24 x 1-1/4	ECI-125	5	25	56	42850
429	1-1/2"	5.2087	2.2694	3.7509	10-24 x 1/2	10-24 x 1-1/4	ECI-150	-	10	88	42950
430	2"	6.6744	2.6634	4.3340	10-24 x 1/2	10-24 x 1-1/4	ECI-200	-	5	135	43000
431	2-1/2"	9.3142	3.6406	5.6421	5/16-18 x 25/32	5/16-18 x 2	ECI-250	-	2	445	43150
432	3"	9.3142	3.9400	6.3670	5/16-18 x 25/32	5/16-18 x 2	ECI-250	-	1	448	43250
433	3-1/2"	12.7656	4.8186	6.9226	5/16-18 x 25/32	5/16-18 x 2	ECI-300-7	-	1	810	43350
434	4"	12.7656	5.2205	7.6239	5/16-18 x 25/32	5/16-18 x 2	ECI-300-7	-	1	875	43450

ALUMINUM SERVICE ENTRANCE HEADS

FOR THREADED RIGID CONDUIT, IMC AND EMT CONDUIT

APPLICATION

Combination entrance cap to fit 2 - 2 1/2" mast and has 1 1/4 - 2" cap.

FEATURES

→ Set-screw type.

STANDARD MATERIALS

Aluminum
Phenolic Insulator



Mast Type

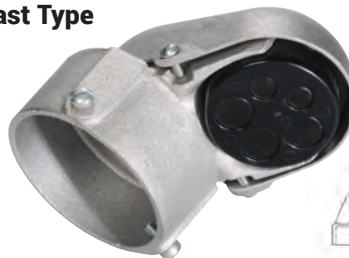

TYPE 3032

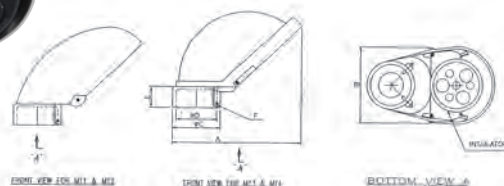

CATALOG NUMBER	TRADE SIZE	DIM A	DIM B	DIM C	DIM D	DIM E	SET SCREW SIZE 'F' (2NOS.)	CONDUIT SIZE	INSULATOR CAP SIZE	UNIT PACK	MASTER PACK	LBS. / 100 PCS.	UPC #
3032	2"	4.7595	3.4396	2.6713	2.4586	1.4026	1/4 - 20 x 5/8	2	1-1/4	-	10	80	30325
3033	2-1/2"	5.3032	3.4120	3.2150	2.9708	1.5602	1/4 - 20 x 1/2	2-1/2	1-1/4	-	10	90	30335
3035	2-1/2"	6.5995	4.6256	3.1441	2.9471	1.1820	1/4 - 20 x 5/8	2-1/2	2	-	5	155	30355

ALUMINUM SERVICE ENTRANCE ELLS WITH COVER AND GASKET

FOR THREADED RIGID CONDUIT AND IMC

APPLICATION

To provide access to the inside of a service raceway, for wire pulling, where the raceway changes direction. Material finish is metallic gray.

FEATURES

→ Assembled with fiber gasket and aluminum die cast cover

STANDARD MATERIALS

Aluminum

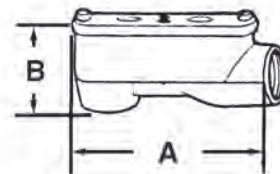

TYPE 412

CATALOG NUMBER	TRADE SIZE	DIM A	DIM B	UNIT PACK	MASTER PACK	LBS. / 100 PCS.	UPC #
412	1/2"	3.79	1.76	10	50	26	41250
413	3/4"	4.02	1.99	10	50	31	41350
414	1"	4.94	2.50	5	25	54	41450
415	1-1/4"	5.60	2.72	-	10	105	41550
415XL*	1-1/4"	7.91	2.75	-	10	140	41551
416	1-1/2"	6.79	3.10	-	10	130	41650
417	2"	7.74	3.88	-	5	170	41750

*Extra Long

ENTRANCE HEADS

FOR THREADED RIGID CONDUIT, IMC, PVC AND EMT CONDUIT

APPLICATION

For outlet boxes and hubs.

FEATURES

→ Water resistant design

STANDARD MATERIALS

PVC

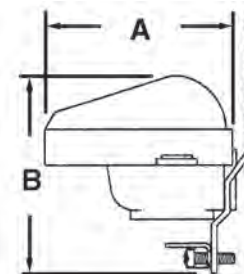

TYPE NS11

CATALOG NUMBER	TRADE SIZE	DIM A	DIM B	UNIT PACK	MASTER PACK	LBS. / 100 PCS.	UPC #
NS9	3-#8,6,4,2	2.75	2.50	-	50	28	34096
NS11	3-#3/0 - 4/0	4.25	4.81	-	10	70	34116

APPLICATION

Used with Type U service entrance cable.

FEATURES

→ Removable cap and two-piece insulator make wire pulling and assembly easy

STANDARD MATERIALS

Aluminum



UL LISTED
E198257



Service Entrance Heads

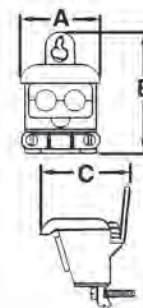

TYPE NS7A

CATALOG NUMBER	TRADE SIZE	DIM A	DIM B	DIM C	UNIT PACK	MASTER PACK	LBS. / 100 PCS.	UPC #
NS2	3-#8 to 3-#1	2.06	2.97	2.26	-	50	26	34025
NS7A	1/0 - 4/0	3.18	4.52	3.60	-	10	31	34175

ZINC CABLE AND CONDUIT CONNECTORS

FOR NON-METALLIC SHEATHED CABLE AND SERVICE ENTRANCE CABLE

APPLICATION

Non-watertight. To make a termination of non-metallic sheathed cable and service entrance.

FEATURES

- Assembled with die cast locknut and tri-combo screws

STANDARD MATERIALS

Zinc Die Cast



Service Entrance Connector

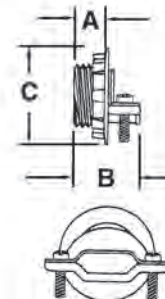
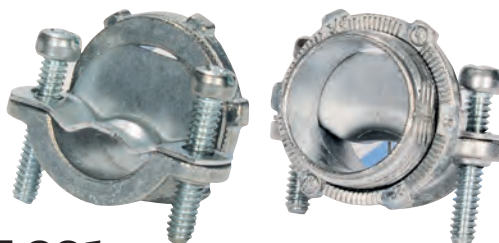

TYPE SC1

CATALOG NUMBER	TRADE SIZE	DIM A	DIM B	DIM C	UNIT PACK	MASTER PACK	LBS. / 100 PCS.	UPC #
SC1	3/4"	0.450	1.031	1.220	25	250	10	32012
SC2	1"	0.645	1.190	1.500	20	200	16	32022
SC3	1-1/4"	0.660	1.330	1.900	10	100	25	32031
SC4	1-1/2"	0.740	1.470	2.115	10	100	36	32042
SC5	2"	0.750	1.620	2.640	5	50	50	32052

CATALOG NUMBER	SE/OVAL DIAMETER IN.	SER/ROUND DIAMETER IN.
SC1 Non-Metallic Cable 10-3 through 8-2	(.52 by .61) and (.51 by .80)	(.59) and (.69)
SC2 Non-Metallic Cable 10-3 through 4-3	(.51 by .80) and (.62 by .975)	(.69) and (.92)
SC3	(1.065 by 0.635) and (1.250 by 0.740)	-
SC4	(1.065 by 0.635) and (1.250 by 0.740)	-
SC5	(1.405 by 0.875) and (1.450 by 0.875)	-

*Please see Cable Chart for Cable Connectors on page 197.

ZINC NON-WATERTIGHT SHORT BODY CONNECTORS

FOR NON-METALLIC SHEATHED CABLE AND SERVICE ENTRANCE CABLE

APPLICATION

Used with locknut to terminate service entrance cable to enclosure.

FEATURES

- Assembled with die cast locknut and tri-combo screws
- For round cable

STANDARD MATERIALS

Zinc Die Cast



*Please see Cable Chart for Cable Connectors on page 197.



TYPE C50S

CATALOG NUMBER	TRADE SIZE	DIM. A MIN.	DIM. A MAX.	DIM B	UNIT PACK	MASTER PACK	LBS. / 100 PCS.	UPC #
C50S	1"	0.620	1.140	1.500	10	100	15	64601
C51S	1-1/4"	0.700	1.380	1.900	10	100	24	64602
C52S	1-1/2"	0.750	1.610	2.115	10	100	34	64603
C53S	2"	0.900	2.040	2.640	5	50	46	64604



TYPE C50ST

CATALOG NUMBER	TRADE SIZE	DIM. A MIN.	DIM. A MAX.	DIM B	UNIT PACK	MASTER PACK	LBS. / 100 PCS.	UPC #
C50ST	1"	0.620	1.140	1.500	10	100	15	90138
C51ST	1-1/4"	0.700	1.380	1.900	25	250	24	90139
C52ST	1-1/2"	0.750	1.610	2.115	25	250	34	90140
C53ST	2"	0.900	2.040	2.640	10	100	46	90141

CATALOG NUMBER	SE/OVAL DIAMETER IN.	SER/ROUND DIAMETER IN.
C50S and C50ST Non-Metallic Cable 10-3 through 4-3	(.51 by .80) and (.62 by .975)	(.69) and (.92)
C51S and C51ST Non-Metallic Cable 4-3 through 2-3	(.67 by 1.06) and (.73 by 1.235)	1.19
C52S and C52ST	(1.15 by 0.73) and (1.41 by 0.89)	1.48
C53S and C53ST	(1.405 by 0.875) and (1.450 by 0.875)	-

*Please see Cable Chart for Cable Connectors on page 197.

ZINC TWO SCREW TAKE-ALL CONNECTORS

FOR ARMORED CABLE, METAL CLAD, FLEXIBLE METALLIC CONDUIT AND NON-METAL SHEATHED CABLE

APPLICATION

Used with locknut to terminate service entrance cable to enclosure.

FEATURES

- Take-all Type
- Concrete tight when tapped

STANDARD MATERIALS

Zinc Die Cast



TYPE C50Z

CATALOG NUMBER	TRADE SIZE	DIM. A MIN.	DIM. A MAX.	DIM B	UNIT PACK	MASTER PACK	LBS. / 100 PCS.	UPC #
C48Z	1/2"	0.40	0.95	1.87	25	250	10	32482
C49Z	3/4"	0.50	1.10	1.84	20	200	12	32492
C50Z	1"	0.62	1.14	2.00	10	100	15	32502
C51Z	1-1/4"	0.50	1.38	2.28	10	100	25	32512
C52Z	1-1/2"	0.75	1.61	2.49	10	100	38	32522
C53Z	2"	0.90	2.04	3.35	5	50	50	32632

*Please see Cable Chart for Cable Connectors on page 197.

Insulated



TYPE C50ZT

CATALOG NUMBER	TRADE SIZE	DIM. A MIN.	DIM. A MAX.	DIM B	UNIT PACK	MASTER PACK	LBS. / 100 PCS.	UPC #
C48ZT	1/2"	0.40	0.95	1.87	25	250	10	34867
C49ZT	3/4"	0.50	1.10	1.84	20	200	12	34967
C50ZT	1"	0.62	1.14	2.00	10	100	15	35067
C51ZT	1-1/4"	0.50	1.38	2.28	10	100	25	35167
C52ZT	1-1/2"	0.75	1.61	2.49	10	100	38	35267
C53ZT	2"	0.90	2.04	3.35	5	50	50	35367

*Please see Cable Chart for Cable Connectors on page 197.

SERVICE ENTRANCE STRAPS AND SILL PLATES

FOR SERVICE ENTRANCE CABLE

APPLICATION

For oval service cable.

FEATURES

→ Steel



TYPE 870S

CATALOG NUMBER	TRADE SIZE	DIM A	DIM B	DIM C	DIM D	UNIT PACK	MASTER PACK	LBS. / 100 PCS.	UPC #
850S	"3-#8, #6, or #4"	1.695	0.400	0.570	0.275	100	1000	2	18507
860S	3-#3 or #2	1.950	0.615	0.580	0.275	100	1000	2	18607
870S	"3-#1#0, #1/0 or #2/0"	2.480	0.800	1.000	0.325	100	1000	8	18707
880S	"3-#3/0, #4/0"	2.795	0.920	1.010	0.325	100	1000	9	18807

APPLICATION

Prevents water from entering structure when used with sealing compound.

STANDARD MATERIALS

Aluminum



TYPE 260L

CATALOG NUMBER	TRADE SIZE	UNIT PACK	MASTER PACK	LBS. / 100 PCS.	UPC #
260L	3/0-4/0"	-	10	70	10010

CABLE CHART FOR CABLE CONNECTORS

SEPCO NUMBERS	K.O. TRADE SIZE	AC CABLE RANGE		MCI CABLE RANGE		MCI-A CABLE RANGE		HCF MCI-A CABLE RANGE	
		STEEL	ALUMINUM	STEEL	ALUMINUM	STEEL	ALUMINUM	STEEL	ALUMINUM
C50S	1"	-	-	-	-	-	-	-	-
C50ST	1"	-	-	-	-	-	-	-	-
C51S	1 1/4"	-	-	-	-	-	-	-	-
C51ST	1 1/4"	-	-	-	-	-	-	-	-
C52S	1 1/2"	-	-	-	-	-	-	-	-
C52ST	1 1/2"	-	-	-	-	-	-	-	-
C53S	2"	-	-	-	-	-	-	-	-
C53ST	2"	-	-	-	-	-	-	-	-
C48Z	1/2"	8/2 - 6/3 0.630"-0.850"	8/2 - 6/3 0.630"-0.835"	8/3 - 6/2 0.690"-0.850"	8/3 - 6/3 0.690"-0.850"	-	8/3 - 6/3 0.675"-0.785"	-	-
C48ZT	1/2"	8/2 - 6/3 0.630"-0.850"	8/2 - 6/3 0.630"-0.835"	8/3 - 6/2 0.690"-0.850"	8/3 - 6/3 0.690"-0.850"	-	8/3 - 6/3 0.675"-0.785"	-	-
C49Z	3/4"	6/3 - 4/2 0.850"- 1.035"	4/3 1.095"	4/3 - 2/3 0.940"-1.080"	4/3 - 2/3 0.940"-1.070"	-	-	-	-
C49ZT	3/4"	6/3 - 4/2 0.850"- 1.035"	4/3 1.095"	4/3 - 2/3 0.940"-1.080"	4/3 - 2/3 0.940"-1.070"	-	-	-	-
C50Z	1"	-	-	1/3 - 1/0-3 1.165"-1.220"	1/3 - 1/0-3 1.145"-1.250"	-	-	-	-
C50ZT	1"	-	-	1/3 - 1/0-3 1.165"-1.220"	1/3 - 1/0-3 1.145"-1.250"	-	-	-	-
C51Z	1 1/4"	-	-	1/0-4 - 2/0-4 1.340"-1.450"	-	-	-	-	-
C51ZT	1 1/4"	-	-	1/0-4 - 2/0-4 1.340"-1.450"	-	-	-	-	-
C52Z	1 1/2"	-	-	4/0-4 - 250-4 1.700"-1.845"	-	-	-	-	-
C52ZT	1 1/2"	-	-	4/0-4 - 250-4 1.700"-1.845"	-	-	-	-	-
C53Z	2"	-	-	350-4 - 400-4 2.070"-2.180"	-	-	-	-	-
C53ZT	2"	-	-	350-4 - 400-4 2.070"-2.180"	-	-	-	-	-
SC1	3/4"	-	-	1/0-4 - 2/0-4 1.340"-1.450"	-	-	-	-	-
SC2	1"	-	-	1/0-4 - 2/0-4 1.340"-1.450"	-	-	-	-	-
SC3	1 1/4"	-	-	1/0-4 - 2/0-4 1.340"-1.450"	-	-	-	-	-
SC4	1 1/2"	-	-	1/0-4 - 2/0-4 1.340"-1.450"	-	-	-	-	-
SC5	2"	-	-	1/0-4 - 2/0-4 1.340"-1.450"	-	-	-	-	-

CABLE CHART FOR CABLE CONNECTORS

SEPCO NUMBERS	FMC TRADE SIZE		RWFMC TRADE SIZE		NM CABLE RANGE	FLEX CORD DIA. RANGE	SE OVAL CABLE RANGE	SER ROUND CABLE DIA. RANGE
	STEEL	ALUMINUM	STEEL	ALUMINUM				
C50S	-	-	-	-	10/3 - 4/3	-	0.510" X 0.800" 0.620" X 0.975"	0.690"-0.920"
C50ST	-	-	-	-	10/3 - 4/3	-	0.510" X 0.800" 0.620" X 0.975"	0.690"-0.920"
C51S	-	-	-	-	4/3 - 2/3	-	0.670" X 0.1.060" 0.730" X 1.235"	1.190"
C51ST	-	-	-	-	4/3 - 2/3	-	0.670" X 0.1.060" 0.730" X 1.235"	1.190"
C52S	-	-	-	-	-	-	0.730" X 1.150" 0.890" X 1.410"	1.480"
C52ST	-	-	-	-	-	-	0.730" X 1.150" 0.890" X 1.410"	1.480"
C53S	-	-	-	-	-	-	0.875" X 1.405" 0.875" X 1.450"	-
C53ST	-	-	-	-	-	-	0.875" X 1.405" 0.875" X 1.450"	-
C48Z	1/2"	1/2"	1/2"	1/2"	14/2 - 12/3	-	-	8/3 0.612"
C48ZT	1/2"	1/2"	1/2"	1/2"	14/2 - 12/3	-	-	8/3 0.612"
C49Z	3/4"	3/4"	3/4"	3/4"	14/3 - 8/3	-	-	8/3 - 6/3 0.612"-0.717"
C49ZT	3/4"	3/4"	3/4"	3/4"	14/3 - 8/3	-	-	8/3 - 6/3 0.612"-0.717"
C50Z	1" 1.300"-1.380"	1" 1.300"-1.380"	1" 1.300"-1.380"	1" 1.300"-1.380"	10/3 - 6/3 0.360"-0.650"	-	4/3 0.499"-0.800"	-
C50ZT	1" 1.300"-1.380"	1" 1.300"-1.380"	1" 1.300"-1.380"	1" 1.300"-1.380"	10/3 - 6/3 0.360"-0.650"	-	4/3 0.499"-0.800"	-
C51Z	1 1/4"	1 1/4"	1 1/4"	1 1/4"	8/3 - 2/3	-	-	-
C51ZT	1 1/4"	1 1/4"	1 1/4"	1 1/4"	8/3 - 2/3	-	-	-
C52Z	1 1/2"	1 1/2"	1 1/2"	1 1/2"	2/3	-	-	-
C52ZT	1 1/2"	1 1/2"	1 1/2"	1 1/2"	2/3	-	-	-
C53Z	2"	2"	2"	2"	-	-	-	-
C53ZT	2"	2"	2"	2"	-	-	-	-
SC1	-	-	-	-	10/3 - 8/2	-	0.520" X 0.610" 0.510" X 0.800"	0.57" - 0.69"
SC2	-	-	-	-	10/3 - 4/3	-	0.510" X 0.800" 0.620" X 0.965"	0.69" - 0.92"
SC3	-	-	-	-	-	-	0.635" X 1.065 0.740" X 1.250"	-
SC4	-	-	-	-	-	-	0.635" X 1.065 0.740" X 1.250"	-
SC5	-	-	-	-	-	-	0.875" X 1.405" 0.875" X 1.450"	-





MISCELLANEOUS FITTINGS

Knock-Out Seals.....	200	Jack Chain and Male Loops.....	204
Sealing Duct Compound.....	201	Kenny Clamps.....	205
Anti-Short Bushings and Rod Couplings.....	202	Lay-In Grounding Lugs.....	206
Sealing Gaskets.....	203		

KNOCK-OUT SEALS

APPLICATION

To close unused opening or knockout in sheet metal box, enclosure or cabinet.

STANDARD MATERIALS

Steel

STANDARD FINISH

Zinc Plated



TYPE SS50

CATALOG NUMBER	TRADE SIZE	DIM A	DIM B	UNIT PACK	MASTER PACK	LBS. / 100 PCS.	UPC #
SS50	1/2"	1.070	0.365	200	2000	1	22507
SS52	3/4"	1.235	0.310	100	1000	2	22527
SS54	1"	1.480	0.335	100	1000	3	22547
SS56	1-1/4"	1.800	0.310	50	500	4	22567
SS58	1-1/2"	2.215	0.365	50	500	5	22587
SS60	2"	2.675	0.360	25	250	7	22607
*SS62	2-1/2"	2.975	0.410	10	100	15	22627
*SS64	3"	4.500	0.465	10	50	40	90147
*SS66	3-1/2"	5.000	0.487	10	50	50	90148
*SS68	4"	5.500	0.4962	10	50	50	90149

* Three-Piece Knock-Out Seals

SEALING DUCT COMPOUND

ASBESTOS FREE

APPLICATION

Sealer is used primarily by the building and specifically by the electrical trade to seal around junction boxes, flashing, and service mast entries, etc. It can be shaped by hand to any form and reused if necessary. Duct seal has countless other applications in the refrigeration, heating and cooling, plumbing and metal fabrication fields, as well as being an excellent general purpose sealant around the home. Duct seal may be painted immediately after application and will not bleed through the dry paint film.

PHYSICAL & CHEMICAL CHARACTERISTICS:

- Base: Non-drying synthetic polymers and oils.
- Odor: No unpleasant odor
- Temperature tolerance range: -30°F to +175°F. Will not slump at 350° for 1 hr.
- Fillers: Saturated mineral fillers and other inert ingredients.
- Specified gravity: 1.98 ± 0.06
- Temperature usage range (recommended) 25°F to 120°F.
- Shelf life: 1 year from the manufacturing date.

DESCRIPTION

This asbestos-free sealer is a gray, permanently soft, non toxic, non-volatile compound which will adhere to most clean, dry surfaces. It will not adversely affect other plastic materials or corrode metals and has no adverse effect on human skin.



TYPE SD1

CATALOG NUMBER	TRADE SIZE	UNIT PACK	MASTER PACK	LBS. / 100 PCS.	UPC #
SD1	1 lb. bag	1	50	100	67001
SD5	5 lb. Bag	5	50	500	67005



ANTI-SHORT BUSHINGS AND ROD COUPLINGS

THEρμοPLASTIC

APPLICATION

These anti-short bushings are used in the terminations of flexible metal conduit and armored cables. Inserted into I.D. of each termination point to protect the conductors from the sharp edges of the raceway where cut.

FEATURES

- Features high dielectric strength and assures complete insulation on all sharp edges

STANDARD MATERIALS

Plastic

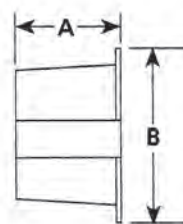

TYPE 0

CATALOG NUMBER	TRADE SIZE	DIM A	DIM B	FOR CABLE SIZES	PC. PER BAG	UNIT PACK	MASTER PACK	LBS. / 100 PCS.	UPC #
0	5/16"	0.57	0.64	14-2, 14-3, 12-2, Armored Cable; 5/169 Flexible Conduit	35	1 BAG	500 BAGS	3	55506
1	3/8"	0.67	0.66	14-4, 12-3, 6-1, 4-1, Armored Cable; 3/89 Flexible Conduit	35	1 BAG	400 BAGS	3	55516
2	7/16"	0.61	0.82	12-4, 10-2, 10-3, 2-1, Armored Cable; 7/169 Flexible Conduit	35	1 BAG	300 BAGS	7	55526
3	1/2"	0.67	0.94	10-4, 8-2, 8-3, 1-1, Armored Cable; 1/29 Flexible Conduit	20	1 BAG	200 BAGS	8	55536
4	3/4"	0.79	1.16	8-4, 6-2, 6-3, Armored Cable; 3/49 Flexible Conduit	16	1 BAG	150 BAGS	6	55546

STANDARD MATERIALS

Steel

STANDARD FINISH

Zinc Plated

Rod Couplings



TYPE 120R

CATALOG NUMBER	TRADE SIZE	UNIT PACK	MASTER PACK	LBS. / 100 PCS.	UPC #
118R	1/4" - 20"	100	1000	2	11187
120R	3/8" - 16"	100	1000	4	11207
121R	1/2" - 13"	100	1000	6	11217

SEALING GASKETS

SELF RETAINING PVC GASKET WITH STEEL RINGS

APPLICATION

To insure Raintight integrity for Rigid Conduit Fittings

FEATURES

- PVC Gasket
- Steel Retaining Ring

STANDARD MATERIALS

PVC Gasket/Steel Rings

STANDARD FINISH

Zinc Plated

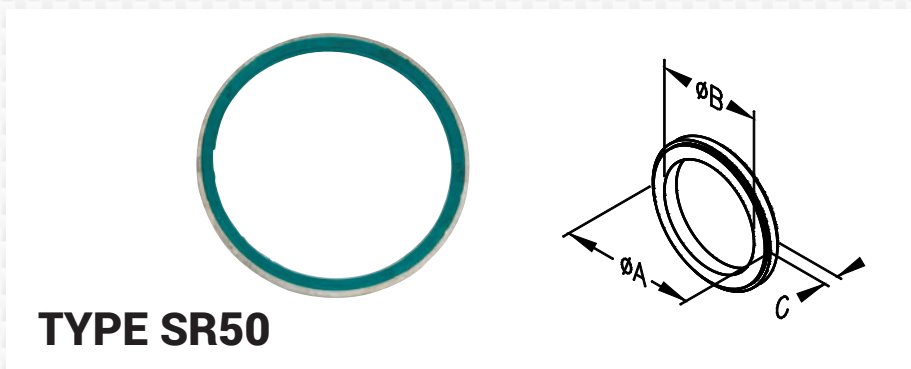

TYPE SR50

CATALOG NUMBER	TRADE SIZE	DIM A	DIM B	DIM C	UNIT PACK	MASTER PACK	LBS. /100 PCS.	UPC #
SR50	3/8" - 1/2"	1.125	0.813	0.187	100	500	1	70850
SR75	3/4"	1.375	1.125	0.187	100	500	2	70851
SR100	1"	1.625	1.313	0.187	100	500	2	70852
SR125	1-1/4"	2.000	1.625	0.187	50	250	3	70853
SR150	1-1/2"	2.250	1.875	0.187	50	250	3	70854
SR200	2"	2.750	2.313	0.187	50	250	3	70855
SR250	2-1/2"	3.500	2.875	0.187	-	10	6	70856
SR300	3"	4.250	3.500	0.187	-	10	9	70857
SR350	3-1/2"	4.750	4.000	0.187	-	10	10	70858
SR400	4"	5.188	4.500	0.187	-	10	13	70859
SR500	5"	6.563	5.563	0.187	-	5	16	70860
SR600	6"	7.750	6.625	0.187	-	5	19	70861

JACK CHAIN AND MALE LOOPS

APPLICATION

Used for hanging fixtures.

STANDARD MATERIALS

Steel

No. 12 also available on 250' & 500' Reels.
Additional charge of \$10.00 M Ft. No. 12 Chain -
Load Capacity 29 lbs. per 100' No. 10 Chain - Load
Capacity 47 lbs. per 100'

Jack Chain

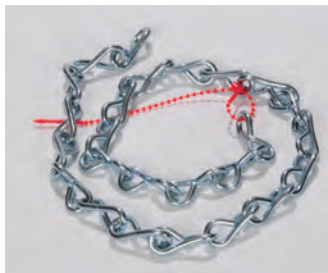

TYPE 220

CATALOG NUMBER	AVAILABLE IN	TYPE	UNIT PACK	MASTER PACK	LBS. / 100 PCS.	UPC #
220	No. 12 (100' & 50' Hanks)	Plain Polished	50 FEET	1000 FEET	10	82207
220R	No. 12 (100' & 50' Reels)	Plain Polished	50 FEET	1000 FEET	10	82208
221	No. 12 (100' & 50' Hanks)	Zinc Plated	50 FEET	1000 FEET	12	82217
222	No. 10 (100' Hanks)	Plain Polished	50 FEET	1000 FEET	14	82227

APPLICATION

Used with fixture chain to hang lighting fixtures.

STANDARD MATERIALS

Zinc Die Cast



TYPE 215

CATALOG NUMBER	TRADE SIZE	UNIT PACK	MASTER PACK	LBS. / 100 PCS.	UPC #
215	1/2"	100	1000	12	82152

KENNY CLAMPS®

BONDING AND GROUNDING CONNECTOR

APPLICATION

Clamp connector is for bonding and grounding of electrode conductors in panel boards, transformers, raceways and enclosures.

FEATURES

- The Kenny Clamp is the ONLY UL Listed connector for bonding and grounding of electrode conductors
- Assures good metallic connection and low impedance path for grounding and bonding of electrical equipment
- Tested and listed at 9000 amperes
- Complies with 110.3 (B) 250.8 and 312.5 A NEC, using a listed grounding or bonding connector for the proper application
- Meets UL 467 requirements for bonding and grounding and UL 468A standard for connectors

STANDARD MATERIALS

Brass



TYPE KC1AST

CATALOG NUMBER	TRADE SIZE	UNIT PACK	MASTER PACK	LBS. /100 PCS.	UPC #
KC1AST	#1/0 AWG STRANDED	-	10	34	99900
KC2AST	#2/0 AWG STRANDED	-	10	34	99901
KC2ST	#2 AWG STRANDED	-	10	52	99902
KC3AST	#3/0 AWG STRANDED	-	10	52	99903
KC4SO	#4 AWG SOLID	-	10	52	99904
KC4ST	#4 AWG STRANDED	-	10	65	99905
KC6SO	#6 AWG SOLID	-	10	65	99906
KC6ST	#6 AWG STRANDED	-	10	87	99907
KC8SO	#8 AWG SOLID	-	10	87	99908
KC8ST	#8 AWG STRANDED	-	10	87	99909

PATENT PENDING

LAY-IN GROUNDING LUGS

FEATURES

- Each lug takes a range of cable sizes
- Heavy duty slotted or hex head screw
- Both Aluminum and Copper lay-in lugs are suitable for use with copper or aluminum conductors

STANDARD MATERIALS

Aluminum

STANDARD FINISH

Zinc Plated



Aluminum



TYPE AL4

AL4 and AL1/0 are furnished with slotted screws. AL3/0 and AL250 are furnished with hex-head screws.

CATALOG NUMBER	TRADE SIZE	DIM A	DIM B	DIM C	UNIT PACK	MASTER PACK	LBS. / 100 PCS.	UPC #
AL4	4/14	1.063	0.375	0.750	-	100	2	10001
AL1/0	1/0 - 8	1.500	0.625	1.125	-	100	7	10002
AL3/0	3/0 - 6	2.000	0.813	1.500	-	50	16	10003
AL250	250MCM - 6	2.188	0.813	1.688	-	50	19	10004

STANDARD MATERIALS

Copper

STANDARD FINISH

Natural



Copper

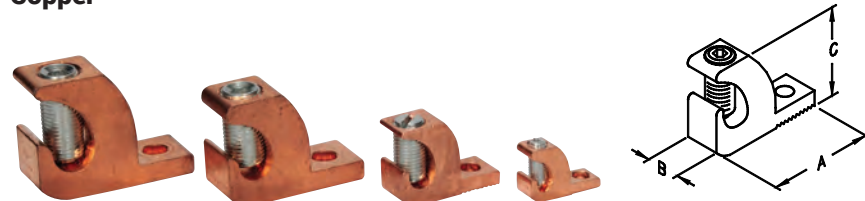

TYPE CL4

CL4 and CL1/0 are furnished with slotted screws. CL3/0 and CL250 are furnished with hex-head screws.

CATALOG NUMBER	TRADE SIZE	DIM A	DIM B	DIM C	UNIT PACK	MASTER PACK	LBS. / 100 PCS.	UPC #
CL4	4/14	1.063	0.375	0.750	-	100	4	10005
CL1/0	1/0 - 8	1.500	0.625	1.125	-	100	16	10006
CL3/0	3/0 - 6	2.000	0.813	1.500	-	50	40	10007
CL250	250MCM - 6	2.188	0.813	1.688	-	50	50	10008

NOTES:

INDEX BY CATALOG NUMBER

Catalog #	Page	Catalog #	Page	Catalog #	Page	Catalog #	Page
0	202	1017	116	11	55, 106	1213SS	62
01	53, 105	1018	116	1110	113	1213Z	63
01A	53, 105	1019	116	1111	113	1214	62
01M	54	1020	116	1112	113	1214SS	62
01MG	13, 54	1021	116	1112A	113	1214Z	63
02	53, 105	1021D	116	1112B	113	1215	62
02A	53, 105	1021E	116	1112C	113	1215SS	62
02M	54	1021E1	116	1112D	113	1215Z	63
02MG	13, 54	1021F	116	1112E	113	1216	62
03	53, 105	1022	76	1112E1	113	1216SS	62
03A	53, 105	1022G	15, 76	1112F	113	1217	62
03M	54	1023	76	1113	114	1217SS	62
03MG	13, 54	1023G	15, 76	1114	114	121R	202
04	53, 105	1024	76	1115	114	1250	119
04A	53, 105	1024G	15, 76	1115A	114	1251	119
04M	54	1025	76	1115B	114	1260	119
04MG	13, 54	1025G	15, 76	1115C	114	1261	119
05	53, 105	1026	76	1115E	114	12CS	182
05A	53, 105	1026G	15, 76	1115E1	114	13	55, 106
05M	54	1027	76	1115F	114	130S	88
05MG	13, 54	1027G	15, 76	118R	202	1313	84
06	53, 105	1028	76	11CS	182	1314	84
06A	53, 105	1028G	15, 76	12	55, 106	1315	84
06M	54	1029	76	1206	62	1316	84
06MG	13, 54	1029G	15, 76	1206SS	62	131S	88
07	53, 105	1030	76	1206Z	63	132	86
07A	53, 105	1030G	15, 76	1207	62	1320	84
07M	54	1031	76	1207SS	62	1321	84
07MG	13, 54	1031G	15, 76	1207Z	63	1326	118
1	202	1060	188	1208	62	1327	118
10	55, 106	1060A	188	1208SS	62	1328	118
1005	76	1064	188	1208Z	63	1329	118
1005G	15, 76	1066	188	1209	62	132G	22, 87
1006	76	1066A	188	1209SS	62	132S	88
1006G	15, 76	1068	188	1209Z	63	133	86
1010	115	1068A	188	120R	202	1332	118
1011	115	1069	188	1210	62	1333	118
1012	115	1069A	188	1210SS	62	133G	22, 87
1013	115	1069B	188	1210Z	63	133S	88
1014	115	1069C	188	1211	62	134	86
1015	115	1069D	188	1211SS	62	134G	22, 87
1015D	115	10B	178	1211Z	63	134S	88
1015E	115	10BB	178	1212	62	135	86
1015E1	115	10BG	178	1212SS	62	135G	22, 87
1015F	115	10BR	178	1212Z	63	135S	88
1016	116	10CS	182	1213	62	136	86

INDEX BY CATALOG NUMBER

Catalog #	Page	Catalog #	Page	Catalog #	Page	Catalog #	Page
136G	22, 87	173C	121, 157	22BI4LSS	59	29BI0L	57
136S	88	17CS	182	22BIZ4L	61	29BI0LSS	59
137	86	18CS	182	22E	82, 156	29BI40L	57
137G	22, 87	19CS	182	23BI4L	57	29BI40LSS	59
137S	88	1F	93	23BI4LG	14, 58	29BI40LG	14, 58
138	86	2	202	23BI4LSS	59	29BI0LG	14, 58
138G	22, 87	200	180	23BIZ4L	61	29BIZ0L	61
138S	88	201	180	23E	82, 156	29BIZ40L	61
139	86	202	180	24BI4L	57	2F	93
139G	22, 87	20BI4L	57	24BI4LG	14, 58	3	202
139S	88	20BI4LG	14, 58	24BI4LSS	59	301	180
13CS	182	20BI4LSS	59	24BIZ4L	61	302	180
13CSA	182	20BIZ40L	61	24E	82, 156	3032	191
14	55, 106	2132S	88	25BI0L	57	3033	191
141	86	2133S	88	25BI4L	57	3035	191
141G	22, 87	2134S	88	25BI4LG	14, 58	307	180
141S	88	2135S	88	25BI4LSS	59	308	180
142S	120	2136S	88	25BIZ0L	61	309	180
143S	120	2137S	88	25E	82, 156	30BI40L	57
144S	120	2138S	88	260L	196	30BI40LSS	59
145S	120	2139S	88	26BI0L	57	30BI40LG	14, 58
146S	120	2141S	88	26BI0LSS	59	310	180
147S	120	2142S	120	26BI40L	57	311	180
148	86	2143S	120	26BI40LSS	59	312	180
148G	22, 87	2144S	120	26BI40LG	14, 58	313	180
148S	88	2145S	120	26BI0LG	14, 58	315M	153
14CS	182	2146S	120	26BIZ0L	61	316M	153
15	55, 106	2147S	120	26BIZ40L	61	317M	153
150	86	2148S	88	270	56	31BI40L	57
150G	22, 87	215	204	270G	56	31BI40LSS	59
152	86	2150S	88	27BI0L	57	31BI40LG	14, 58
152G	22, 87	2152S	88	27BI0LSS	59	34B	178
158S	120	2158S	120	27BI40L	57	35A	178
159S	120	2159S	120	27BI40LSS	59	35B	179
15CS	182	2160S	120	27BI40LG	14, 58	35C	180
16	55, 106	2161S	120	27BI0LG	14, 58	35D	180
160S	120	21BI4L	57	27BIZ0L	61	35E	180
161S	120	21BI4LG	14, 58	27BIZ40L	61	36A	178
16CS	182	21BI4LSS	59	28BI0L	57	36C	180
170	56	21BIZ4L	61	28BI0LSS	59	36D	180
170C	121, 157, 169	220	204	28BI40L	57	36E	180
170G	56	220R	204	28BI40LSS	59	370	56
171	121, 157	221	204	28BI40LG	14, 58	370G	56
171C	121, 157	222	204	28BI0LG	14, 58	3F	93
172	121, 157	22BI4L	57	28BIZ0L	61	4	202
172C	121, 157	22BI4LG	14, 58	28BIZ40L	61	400	189

INDEX BY CATALOG NUMBER

Catalog #	Page	Catalog #	Page	Catalog #	Page	Catalog #	Page
401	189	470	56	715P	74	901	86
402	189	470G	56	716	74	901G	22, 87
403	189	4F	93	716P	74	902	86
404	189	530M	66	717	74	902G	22, 87
405	189	531M	66	717P	74	903	86
406	189	532M	66	806	64	903G	22, 87
4060	115	533M	66	806Z	64	904	86
4061	115	534M	66	807	64	904G	22, 87
4062	115	535M	66	807Z	64	905	86
4063	115	536M	66	808	64	905G	22, 87
4064	115	537M	66	808Z	64	906	86
4065	115	538M	66	809	64	906G	22, 87
4065D	115	539M	66	809Z	64	907	86
4065E	115	559M	66	810	64	907G	22, 87
4065E1	115	569M	66	810Z	64	908	86
4065F	115	570	56	811	64	908G	22, 87
4066	113	570G	56	811Z	64	909	86
4067	113	5F	93	812	64	909G	22, 87
4068	113	620	185	812Z	64	90T	71
4069	113	621	185	814	64	90Z	70
407	189	625	185	814Z	64	90ZT	70
4070	113	626	185	815	64	91	71
4071	113	627	185	815Z	64	910	86
4072	113	670	56	816	64	910G	22, 87
4073	113	670G	56	816Z	64	911	86
4074	113	6F	93	817	64	911G	22, 87
4075	113	705X	75	818	64	91T	71
408	189	706	74	820Z	66	91Z	70
409	189	706P	74	821Z	66	91ZT	70
412	191	707	74	822Z	66	92	71
413	191	707P	74	823Z	66	92T	71
414	191	708	74	824Z	66	92Z	70
415	191	708P	74	825Z	66	92ZT	70
415XL	191	709	74	838Z	66	93	71
416	191	709P	74	839Z	66	93T	71
417	191	710	74	840Z	66	93Z	70
425	190	710P	74	841Z	66	93ZT	70
426	190	711	74	850S	196	94	71
427	190	711P	74	860S	196	94T	71
428	190	712	74	870	56	94Z	70
429	190	712P	74	870G	56	94ZT	70
430	190	713	74	870S	196	95	71
431	190	713P	74	880S	196	95T	71
432	190	714	74	90	71	95Z	70
433	190	714P	74	900	86	95ZT	70
434	190	715	74	900G	22, 87	96	71

INDEX BY CATALOG NUMBER

Catalog #	Page	Catalog #	Page	Catalog #	Page	Catalog #	Page
96T	71	C22	155	C34	147	C47F7	41
96Z	70	C22M	152	C34T	147	C47Z	149
96ZT	70	C23	166	C35	148	C48Z	151, 168, 195
97	71	C23C	155	C35T	148	C48ZT	151, 168, 195
970	56	C25	148	C35Z	150	C49Z	151, 168, 195
970G	56	C25T	148	C35ZT	150	C49ZT	151, 168, 195
97T	71	C25Z	150	C36	148	C4A	44
97Z	70	C25ZT	150	C36T	148	C4ACG	47
97ZT	70	C27	147	C36Z	150	C4AT	96
98	71	C270	154	C36ZT	150	C4ATCG	99
98T	71	C270A	154	C37	148	C4CA	50, 102
98Z	70	C270M	152	C37F7	41	C4G	11, 38
98ZT	70	C271	153	C37T	148	C5	35
99	71	C27F7	41	C37Z	150	C50S	167, 194
995	71	C27T	147	C37ZT	150	C50ST	167, 194
995T	71	C27Z	149	C38	148	C50Z	151, 168, 195
996	71	C27ZT	149	C38T	148	C50ZT	151, 168, 195
996T	71	C28	147	C38Z	150	C51S	167, 194
99T	71	C28T	147	C38ZT	150	C51ST	167, 194
99Z	70	C28Z	149	C39	148	C51Z	151, 168, 195
99ZT	70	C28ZT	149	C39T	148	C51ZT	151, 168, 195
AL4	206	C29	147	C39Z	150	C52S	167, 194
AL1/0	206	C29T	147	C39ZT	150	C52ST	167, 194
AL3/0	206	C29Z	149	C3A	44	C52Z	151, 168, 195
AL250	206	C29ZT	149	C3ACG	47	C52ZT	151, 168, 195
BRLG-1504	60	C2A	44	C3AT	96	C53S	167, 194
BRLG-2004	60	C2ACG	47	C3ATCG	99	C53ST	167, 194
BRLG-3104	60	C2AT	96	C3CA	50, 102	C53Z	151, 168, 195
BS50	82	C2ATCG	99	C3G	11, 38	C53ZT	151, 168, 195
BS75	82	C2CA	50, 102	C4	35	C57F7	41
C1	35	C2G	11, 38	C40	148	C5A	44
C10	35	C3	35	C40T	148	C5ACG	47
C107F7	41	C30	147	C40Z	150	C5AT	96
C10A	44	C30T	147	C40ZT	150	C5ATCG	99
C10ACG	47	C30Z	149	C41	69	C5CA	50, 102
C10AT	96	C30ZT	149	C42	69	C5G	11, 38
C10ATCG	99	C31	147	C43	69	C6	35
C10G	11, 38	C31T	147	C44	69	C60	147
C17F7	41	C31Z	149	C45	69	C60T	147
C1A	44	C31ZT	149	C46	69	C61	147
C1ACG	47	C32	147	C465	69	C61T	147
C1AT	96	C32T	147	C466	69	C65	148
C1ATCG	99	C32Z	149	C467	69	C65T	148
C1CA	50, 102	C32ZT	149	C468	69	C66	148
C1G	11, 38	C33	147	C47A	147	C66T	148
C2	35	C33T	147	C47AT	147	C67	148

INDEX BY CATALOG NUMBER

Catalog #	Page	Catalog #	Page	Catalog #	Page	Catalog #	Page
C67F7	41	CG100-85090	175	CG50-650	174	CL4	206
C67T	148	CG100-950	174	CG50-65045	176	CL1/0	206
C68	148	CG100-95045	176	CG50-65090	175	CL3/0	206
C68T	148	CG100-95090	175	CG75-250	174	CL250	206
C6A	44	CG125-1050	174	CG75-25045	176	CR0	89
C6ACG	47	CG125-105045	176	CG75-25090	175	CR1	89
C6AT	96	CG125-105090	175	CG75-350	174	CR10	89
C6ATCG	99	CG125-1150	174	CG75-35045	176	CR11	89
C6CA	50, 102	CG125-115045	176	CG75-35090	175	CR12	89
C6G	11, 38	CG125-115090	175	CG75-450	174	CR13	89
C7	35	CG125-1250	174	CG75-45045	176	CR14	89
C77F7	41	CG125-125045	176	CG75-45090	175	CR15	89
C7A	44	CG125-125090	175	CG75-560	174	CR18	89
C7ACG	47	CG125-1375	174	CG75-56045	176	CR19	89
C7AT	96	CG125-137545	176	CG75-56090	175	CR2	89
C7ATCG	99	CG125-137590	175	CG75-650	174	CR20	89
C7G	11, 38	CG125-850	174	CG75-65045	176	CR21	89
C8	35	CG125-85045	176	CG75-65090	175	CR24	89
C87F7	41	CG125-85090	175	CG75-750	174	CR25	89
C8A	44	CG125-950	174	CG75-75045	176	CR26	89
C8ACG	47	CG125-95045	176	CG75-75090	175	CR27	89
C8AT	96	CG125-95090	175	CG75-850	174	CR28	89
C8ATCG	99	CG150-1050	174	CG75-85045	176	CR3	89
C8G	11, 38	CG150-105045	176	CG75-85090	175	CR34	89
C9	35	CG150-105090	175	CHM100	72	CR35	89
C920	156	CG150-1150	174	CHM100G	15, 72	CR36	89
C97F7	41	CG150-115045	176	CHM125	72	CR4	89
C9A	44	CG150-115090	175	CHM125G	15, 72	CR42	89
C9ACG	47	CG150-1250	174	CHM150	72	CR43	89
C9AT	96	CG150-125045	176	CHM150G	15, 72	CR44	89
C9ATCG	99	CG150-125090	175	CHM200	72	CR45	89
C9G	11, 38	CG150-1375	174	CHM200G	15, 72	CR46	89
CG100-1050	174	CG150-137545	176	CHM250	72	CR47	89
CG100-105045	176	CG150-137590	175	CHM250G	15, 72	CR5	89
CG100-105090	175	CG50-250	174	CHM300	72	CR6	89
CG100-560	174	CG50-25045	176	CHM300G	15, 72	CR7	89
CG100-56045	176	CG50-25090	175	CHM350	72	CR8	89
CG100-56090	175	CG50-350	174	CHM350G	15, 72	CR9	89
CG100-650	174	CG50-35045	176	CHM400	72	CSB-200	23, 65
CG100-65045	176	CG50-35090	175	CHM400G	15, 72	CSB-250	23, 65
CG100-65090	175	CG50-450	174	CHM50	72	CSB-300	23, 65
CG100-750	174	CG50-45045	176	CHM500	72	CSB-350	23, 65
CG100-75045	176	CG50-45090	175	CHM50G	15, 72	CSB-400	23, 65
CG100-75090	175	CG50-560	174	CHM600	72	CW101	91
CG100-850	174	CG50-56045	176	CHM75	72	CW102	91
CG100-85045	176	CG50-56090	175	CHM75G	15, 72	CW103	91

INDEX BY CATALOG NUMBER

Catalog #	Page	Catalog #	Page	Catalog #	Page	Catalog #	Page
CW104	91	DB125-IC	142	FDC2-100	28	HCR11	90
CW105	91	DB150-IC	142	FDC2-50	28	HCR12	90
CW106	91	DB200-IC	142	FDC2-75	28	HCR13	90
CW107	91	DB250-IC	142	FS-100	26	HCR14	90
CW108	91	DB300-IC	142	FS-50	26	HCR15	90
CW109	91	DB350-IC	142	FS-75	26	HCR16	90
CW19	91	DB3845-IC	143	FS2-100	28	HCR17	90
CW20	91	DB3890-IC	142	FS2-50	28	HCR18	90
CW21	91	DB38-IC	142	FS2-75	28	HCR19	90
CW31	91	DB400-IC	142	FSC-100	26	HCR2	90
CW32	91	DB5045-IC	143	FSC-50	26	HCR20	90
CW41	91	DB5090-IC	142	FSC-75	26	HCR21	90
CW42	91	DB50-IC	142	FSC2-100	28	HCR22	90
CW43	91	DB7545-IC	143	FSC2-50	28	HCR23	90
CW51	91	DB7590-IC	142	FSC2-75	28	HCR24	90
CW52	91	DB75-IC	142	FSFD2-CG	29	HCR25	90
CW53	91	DBC-38	144	FSFD2-CM1	29	HCR26	90
CW54	91	DBC-50	144	FSFD2-CM2	29	HCR27	90
CW61	91	DBC-75	144	FSFD2-CS1	29	HCR28	90
CW62	91	DBS-38	144	FSFD2-CS2	29	HCR29	90
CW63	91	DBS-50	144	FSFD2-CS3	29	HCR3	90
CW64	91	DBS-75	144	FSFD2-CS4	29	HCR30	90
CW65	91	E35	93	FSFD2-CS5	29	HCR31	90
CW70	91	E36	93	FSFD2-CS6	29	HCR32	90
CW71	91	E37	93	FSFDCG	27	HCR33	90
CW73	91	E38	93	FSFDCM1	27	HCR34	90
CW74	91	EDG100	184	FSFDCM2	27	HCR35	90
CW75	91	EDG125	184	FSFDCM3	27	HCR36	90
CW76	91	EDG150	184	FSFDSC1	27	HCR37	90
CW81	91	EDG200	184	FSFDSC2	27	HCR38	90
CW82	91	EDG250	184	FSFDSC3	27	HCR39	90
CW83	91	EDG300	184	FSFDSC4	27	HCR4	90
CW84	91	EDG50	184	GL70	75	HCR40	90
CW85	91	EDG75	184	GL71	75	HCR41	90
CW86	91	ERC-22	81, 117	GL72	75	HCR42	90
CW87	91	ERC-23	81, 117	GL73	75	HCR43	90
CW91	91	ERC-24	81, 117	GL74	75	HCR44	90
CW92	91	FD-100	26	GL75	75	HCR45	90
CW93	91	FD-50	26	GL76	75	HCR46	90
CW94	91	FD-75	26	GL77	75	HCR5	90
CW95	91	FD2-100	28	GL78	75	HCR6	90
CW96	91	FD2-50	28	GL79	75	HCR7	90
CW97	91	FD2-75	28	GL80	75	HCR8	90
CW98	91	FDC-100	26	GL81	75	HCR9	90
DB10090-IC	142	FDC-50	26	HCR1	90	ICC-400	67
DB100-IC	142	FDC-75	26	HCR10	90	JC100	184

INDEX BY CATALOG NUMBER

Catalog #	Page	Catalog #	Page	Catalog #	Page	Catalog #	Page
JC125	184	LB4	35	LL10	36	LL6	36
JC150	184	LB47F7	41	LL107F7	42	LL67F7	42
JC200	184	LB4A	44	LL10A	45	LL6A	45
JC50	184	LB4ACG	47	LL10ACG	48	LL6ACG	48
JC75	184	LB4AT	96	LL10AT	97	LL6AT	97
KC1AST	205	LB4ATCG	99	LL10ATCG	100	LL6ATCG	100
KC2AST	205	LB4CA	50, 102	LL10G	12, 39	LL6CA	51, 103
KC2ST	205	LB4G	11, 38	LL17F7	42	LL6G	12, 39
KC3AST	205	LB5	35	LL1A	45	LL7	36
KC4SO	205	LB57F7	41	LL1ACG	48	LL77F7	42
KC4ST	205	LB5A	44	LL1AT	97	LL7A	45
KC6SO	205	LB5ACG	47	LL1ATCG	100	LL7ACG	48
KC6ST	205	LB5AT	96	LL1CA	51, 103	LL7AT	97
KC8SO	205	LB5ATCG	99	LL1G	12, 39	LL7ATCG	100
KC8ST	205	LB5CA	50, 102	LL2	36	LL7G	12, 39
LB1	35	LB5G	11, 38	LL27F7	42	LL8	36
LB10	35	LB6	35	LL2A	45	LL87F7	42
LB107F7	41	LB67F7	41	LL2ACG	48	LL8A	45
LB10A	44	LB6A	44	LL2AT	97	LL8ACG	48
LB10ACG	47	LB6ACG	47	LL2ATCG	100	LL8AT	97
LB10AT	96	LB6AT	96	LL2CA	51, 103	LL8ATCG	100
LB10ATCG	99	LB6ATCG	99	LL2G	12, 39	LL8G	12, 39
LB10G	11, 38	LB6CA	50, 102	LL3	36	LL9	36
LB17F7	41	LB6G	11, 38	LL37F7	42	LL97F7	42
LB1A	44	LB7	35	LL3A	45	LL9A	45
LB1ACG	47	LB77F7	41	LL3ACG	48	LL9ACG	48
LB1AT	96	LB7A	44	LL3AT	97	LL9AT	97
LB1ATCG	99	LB7ACG	47	LL3ATCG	100	LL9ATCG	100
LB1CA	50, 102	LB7AT	96	LL3CA	51, 103	LL9G	12, 39
LB1G	11, 38	LB7ATCG	99	LL3G	12, 39	LR1	36
LB2	35	LB7G	11, 38	LL4	36	LR10	36
LB27F7	41	LB8	35	LL47F7	42	LR107F7	42
LB2A	44	LB87F7	41	LL4A	45	LR10A	45
LB2ACG	47	LB8A	44	LL4ACG	48	LR10ACG	48
LB2AT	96	LB8ACG	47	LL4AT	97	LR10AT	97
LB2ATCG	99	LB8AT	96	LL4ATCG	100	LR10ATCG	100
LB2CA	50, 102	LB8ATCG	99	LL4CA	51, 103	LR10G	12, 39
LB2G	11, 38	LB8G	11, 38	LL4G	12, 39	LR17F7	42
LB3	35	LB9	35	LL5	36	LR1A	45
LB37F7	41	LB97F7	41	LL57F7	42	LR1ACG	48
LB3A	44	LB9A	44	LL5A	45	LR1AT	97
LB3ACG	47	LB9ACG	47	LL5ACG	48	LR1ATCG	100
LB3AT	96	LB9AT	96	LL5AT	97	LR1CA	51, 103
LB3ATCG	99	LB9ATCG	99	LL5ATCG	100	LR1G	12, 39
LB3CA	50, 102	LB9G	11, 38	LL5CA	51, 103	LR2	36
LB3G	11, 38	LL1	36	LL5G	12, 39	LR27F7	42

INDEX BY CATALOG NUMBER

Catalog #	Page	Catalog #	Page	Catalog #	Page	Catalog #	Page
LR2A	45	LR87F7	42	LT61	139	NTC-150	77
LR2ACG	48	LR8A	45	LT61T	139	NTC-150T	77
LR2AT	97	LR8ACG	48	LT65	140	NTC-200	77
LR2ATCG	100	LR8AT	97	LT65T	140	NTC-200T	77
LR2CA	51, 103	LR8ATCG	100	LT66	140	NTC-250	77
LR2G	12, 39	LR8G	12, 39	LT66T	140	NTC-250T	77
LR3	36	LR9	36	LT67	140	NTC-300	77
LR37F7	42	LR97F7	42	LT67T	140	NTC-300T	77
LR3A	45	LR9A	45	LT68	140	NTC-350	77
LR3ACG	48	LR9ACG	48	LT68T	140	NTC-350T	77
LR3AT	97	LR9AT	97	MC100G	6, 30	NTC-400	77
LR3ATCG	100	LR9ATCG	100	MC125G	6, 30	NTC-400T	77
LR3CA	51, 103	LR9G	12, 39	MC150G	6, 30	NTC-50	77
LR3G	12, 39	LT25	140	MC200G	6, 30	NTC-500	77
LR4	36	LT27	139	MC250G	6, 30	NTC-500T	77
LR47F7	42	LT27T	139	MC300G	6, 30	NTC-50T	77
LR4A	45	LT28	139	MC350G	6, 30	NTC-600	77
LR4ACG	48	LT28T	139	MC400G	6, 30	NTC-600T	77
LR4AT	97	LT29	139	MLB100G	7, 31	NTC-75	77
LR4ATCG	100	LT29T	139	MLB125G	7, 31	NTC-75T	77
LR4CA	51, 103	LT30	139	MLB150G	7, 31	NTCC-100	78
LR4G	12, 39	LT30T	139	MLB200G	7, 31	NTCC-125	78
LR5	36	LT31	139	MLB250G	7, 31	NTCC-150	78
LR57F7	42	LT31T	139	MLB300G	7, 31	NTCC-200	78
LR5A	45	LT32	139	MLB350G	7, 31	NTCC-250	78
LR5ACG	48	LT32T	139	MLB400G	7, 31	NTCC-300	78
LR5AT	97	LT33	139	MLL100G	8, 32	NTCC-350	78
LR5ATCG	100	LT33T	139	MLL125G	8, 32	NTCC-400	78
LR5CA	51, 103	LT34	139	MLL150G	8, 32	NTCC-50	78
LR5G	12, 39	LT34T	139	MLL200G	8, 32	NTCC-500	78
LR6	36	LT35	140	MLR100G	9, 33	NTCC-600	78
LR67F7	42	LT35T	140	MLR125G	9, 33	NTCC-75	78
LR6A	45	LT36	140	MLR150G	9, 33	OSN100	69
LR6ACG	48	LT36T	140	MLR200G	9, 33	OSN125	69
LR6AT	97	LT37	140	MT100G	10, 34	OSN50	69
LR6ATCG	100	LT37T	140	MT125G	10, 34	OSN75	69
LR6CA	51, 103	LT38	140	MT150G	10, 34	P1	92
LR6G	12, 39	LT38T	140	MT200G	10, 34	P10	92
LR7	36	LT39	140	NS11	192	P11	92
LR77F7	42	LT39T	140	NS2	192	P12	92
LR7A	45	LT40	140	NS7A	192	P13	92
LR7ACG	48	LT40T	140	NS9	192	P14	92
LR7AT	97	LT47	139	NTC-100	77	P15	92
LR7ATCG	100	LT47T	139	NTC-100T	77	P16	92
LR7G	12, 39	LT60	139	NTC-125	77	P17	92
LR8	36	LT60T	139	NTC-125T	77	P18	92

INDEX BY CATALOG NUMBER

Catalog #	Page	Catalog #	Page	Catalog #	Page	Catalog #	Page
P19	92	S1012RT	111	S1114	108	SC4	166, 193
P2	92	S1013	109	S1115	108	SC5	166, 193
P20	92	S1013RT	111	S1115A	108	SCC-100	85
P21	92	S1014	109	S1115B	108	SCC-125	85
P3	92	S1014RT	111	S1115C	108	SCC-150	85
PAR100	183	S1015	109	S1115D	108	SCC-200	85
PAR125	183	S1015D	109	S1115E	108	SCC-250	85
PAR150	183	S1015DRT	111	S1115E1	108	SCC-300	85
PAR200	183	S1015E	109	S1115F	108	SCC-350	85
PAR250	183	S1015E1	109	S16ES	81, 117	SCC-400	85
PAR300	183	S1015E1RT	111	S17ES	81, 117	SCC-50	85
PAR350	183	S1015ERT	111	S18ES	81, 117	SCC-500	85
PAR400	183	S1015F	109	S4060	109	SCC-600	85
PAR50	183	S1015FRT	111	S4060RT	111	SCC-75	85
PAR75	183	S1015RT	111	S4061	109	SD1	201
PEF100	83	S1016	110	S4061RT	111	SD5	201
PEF125	83	S1016RT	112	S4062	109	SLT25-45ALT	129
PEF150	83	S1017	110	S4062RT	111	SLT25-45CLT	132
PEF200	83	S1017RT	112	S4063	109	SLT25-45T	126
PEF50	83	S1018	110	S4063RT	111	SLT25ALT	128
PEF75	83	S1018RT	112	S4064	109	SLT25CLT	131
PEM100	83	S1019	110	S4064RT	111	SLT25T	125
PEM125	83	S1019RT	112	S4065	109	SLT27ALT	127
PEM150	83	S1020	110	S4065D	109	SLT27CLT	130
PEM200	83	S1020RT	112	S4065DRT	111	SLT27CLTMG	19, 136
PEM50	83	S1021	110	S4065E	109	SLT27T	124
PEM75	83	S1021D	110	S4065E1	109	SLT27TMG	16, 133
QL-50	146	S1021DRT	112	S4065E1RT	111	SLT28ALT	127
QL-50D	146	S1021E	110	S4065ERT	111	SLT28CLT	130
QL-75	146	S1021E1	110	S4065F	109	SLT28CLTMG	19, 136
RA100	183	S1021E1RT	112	S4065FRT	111	SLT28T	124
RA125	183	S1021ERT	112	S4065RT	111	SLT28TMG	16, 133
RA150	183	S1021F	110	S4066	107	SLT29ALT	127
RA200	183	S1021FRT	112	S4067	107	SLT29CLT	130
RA250	183	S1021RT	112	S4068	107	SLT29CLTMG	19, 136
RA300	183	S1110	107	S4069	107	SLT29T	124
RA350	183	S1111	107	S4070	107	SLT29TMG	16, 133
RA400	183	S1112	107	S4071	107	SLT30ALT	127
RA50	183	S1112A	107	S4072	107	SLT30CLT	130
RA75	183	S1112B	107	S4073	107	SLT30CLTMG	19, 136
RBC-50	179	S1112C	107	S4074	107	SLT30T	124
S1010	109	S1112D	107	S4075	107	SLT30TMG	16, 133
S1010RT	111	S1112E	107	S620	185	SLT31ALT	127
S1011	109	S1112E1	107	SC1	166, 193	SLT31CLT	130
S1011RT	111	S1112F	107	SC2	166, 193	SLT31CLTMG	19, 136
S1012	109	S1113	108	SC3	166, 193	SLT31T	124

INDEX BY CATALOG NUMBER

Catalog #	Page	Catalog #	Page	Catalog #	Page	Catalog #	Page
SLT31TMG	16, 133	SLT38-45ALT	129	SLT62T	124	SLT68TG	17, 134
SLT32ALT	127	SLT38-45CLT	132	SLT62TG	16, 133	SR100	203
SLT32CLT	130	SLT38-45CLTMG	21, 138	SLT63ALT	127	SR125	203
SLT32CLTMG	19, 136	SLT38-45T	126	SLT63CLT	130	SR150	203
SLT32T	124	SLT38-45TMG	18, 135	SLT63CLTG	19, 136	SR200	203
SLT32TMG	16, 133	SLT38ALT	128	SLT63T	124	SR250	203
SLT33ALT	127	SLT38CLT	131	SLT63TG	16, 133	SR300	203
SLT33CLT	130	SLT38CLTMG	20, 137	SLT65-45ALT	129	SR350	203
SLT33CLTMG	19, 136	SLT38T	125	SLT65-45CLT	132	SR400	203
SLT33T	124	SLT38TMG	17, 134	SLT65-45CLTG	21, 138	SR50	203
SLT33TMG	16, 133	SLT39-45ALT	129	SLT65-45T	126	SR500	203
SLT34ALT	127	SLT39-45CLT	132	SLT65-45TG	18, 135	SR600	203
SLT34CLT	130	SLT39-45CLTMG	21, 138	SLT65ALT	128	SR75	203
SLT34CLTMG	19, 136	SLT39-45T	126	SLT65CLT	131	SS50	200
SLT34T	124	SLT39-45TMG	18, 135	SLT65CLTG	20, 137	SS52	200
SLT34TMG	16, 133	SLT39ALT	128	SLT65T	125	SS54	200
SLT35-45ALT	129	SLT39CLT	131	SLT65TG	17, 134	SS56	200
SLT35-45CLT	132	SLT39CLTMG	20, 137	SLT66-45ALT	129	SS58	200
SLT35-45CLTMG	21, 138	SLT39T	125	SLT66-45CLT	132	SS60	200
SLT35-45T	126	SLT39TMG	17, 134	SLT66-45CLTG	21, 138	SS62	200
SLT35-45TMG	18, 135	SLT40-45ALT	129	SLT66-45T	126	SS64	200
SLT35ALT	128	SLT40-45CLT	132	SLT66-45TG	18, 135	SS66	200
SLT35CLT	131	SLT40-45CLTMG	21, 138	SLT66ALT	128	SS68	200
SLT35CLTMG	20, 137	SLT40-45T	126	SLT66CLT	131	ST10	68
SLT35T	125	SLT40-45TMG	18, 135	SLT66CLTG	20, 137	ST11	68
SLT35TMG	17, 134	SLT40ALT	128	SLT66T	125	ST12	68
SLT36-45ALT	129	SLT40CLT	131	SLT66TG	17, 134	ST13	68
SLT36-45CLT	132	SLT40CLTMG	20, 137	SLT67-45ALT	129	ST14	68
SLT36-45CLTMG	21, 138	SLT40T	125	SLT67-45CLT	132	ST15	68
SLT36-45T	126	SLT40TMG	17, 134	SLT67-45CLTG	21, 138	ST16	68
SLT36-45TMG	18, 135	SLT47ALT	127	SLT67-45T	126	ST17	68
SLT36ALT	128	SLT47CLT	130	SLT67-45TG	18, 135	ST18	68
SLT36CLT	131	SLT47T	124	SLT67ALT	128	ST19	68
SLT36CLTMG	20, 137	SLT60ALT	127	SLT67CLT	131	ST20	68
SLT36T	125	SLT60CLT	130	SLT67CLTG	20, 137	ST21	68
SLT36TMG	17, 134	SLT60CLTMG	19, 136	SLT67T	125	SWV-4R	182
SLT37-45ALT	129	SLT60T	124	SLT67TG	17, 134	SWV-4S	182
SLT37-45CLT	132	SLT60TMG	16, 133	SLT68-45ALT	129	T1	37
SLT37-45CLTMG	21, 138	SLT61ALT	127	SLT68-45CLT	132	T10	37
SLT37-45T	126	SLT61CLT	130	SLT68-45CLTG	21, 138	T107F7	43
SLT37-45TMG	18, 135	SLT61CLTMG	19, 136	SLT68-45T	126	T10A	46
SLT37ALT	128	SLT61T	124	SLT68-45TG	18, 135	T10ACG	49
SLT37CLT	131	SLT61TMG	16, 133	SLT68ALT	128	T10AT	98
SLT37CLTMG	20, 137	SLT62ALT	127	SLT68CLT	131	T10ATCG	101
SLT37T	125	SLT62CLT	130	SLT68CLTG	20, 137	T10G	13, 40
SLT37TMG	17, 134	SLT62CLTG	19, 136	SLT68T	125	T17F7	43

INDEX BY CATALOG NUMBER

Catalog #	Page	Catalog #	Page	Catalog #	Page	Catalog #	Page
T1A	46	T57F7	43	T9A	46	TRC-600	79
T1ACG	49	T5A	46	T9ACG	49	TRC-600T	79
T1AT	98	T5ACG	49	T9AT	98	TRC-75	79
T1ATCG	101	T5AT	98	T9ATCG	101	TRC-75T	79
T1CA	52, 104	T5ATCG	101	T9G	13, 40	TRCC-100	80
T1G	13, 40	T5CA	52, 104	TB1	37	TRCC-125	80
T2	37	T5G	13, 40	TB2	37	TRCC-150	80
T27F7	43	T6	37	TB3	37	TRCC-200	80
T2A	46	T67F7	43	TB4	37	TRCC-250	80
T2ACG	49	T6A	46	TB5	37	TRCC-300	80
T2AT	98	T6ACG	49	TB6	37	TRCC-350	80
T2ATCG	101	T6AT	98	TRC-100	79	TRCC-400	80
T2CA	52, 104	T6ATCG	101	TRC-100T	79	TRCC-50	80
T2G	13, 40	T6CA	52, 104	TRC-125	79	TRCC-500	80
T3	37	T6G	13, 40	TRC-125T	79	TRCC-600	80
T37F7	43	T7	37	TRC-150	79	TRCC-75	80
T3A	46	T77F7	43	TRC-150T	79	TWH10	73
T3ACG	49	T7A	46	TRC-200	79	TWH100	73
T3AT	98	T7ACG	49	TRC-200T	79	TWH20	73
T3ATCG	101	T7AT	98	TRC-250	79	TWH30	73
T3CA	52, 104	T7ATCG	101	TRC-250T	79	TWH40	73
T3G	13, 40	T7G	13, 40	TRC-300	79	TWH50	73
T4	37	T8	37	TRC-300T	79	TWH60	73
T47F7	43	T87F7	43	TRC-350	79	TWH70	73
T4A	46	T8A	46	TRC-350T	79	TWH80	73
T4ACG	49	T8ACG	49	TRC-400	79	TWH90	73
T4AT	98	T8AT	98	TRC-400T	79	UF10	169
T4ATCG	101	T8ATCG	101	TRC-50	79	UF20	169
T4CA	52, 104	T8G	13, 40	TRC-500	79		
T4G	13, 40	T9	37	TRC-500T	79		
T5	37	T97F7	43	TRC-50T	79		

